



AKRON  
BRASS COMPANY

100  
*Years*  
1918-2018

**FULL LINE CATALOG**





TRADE MARK

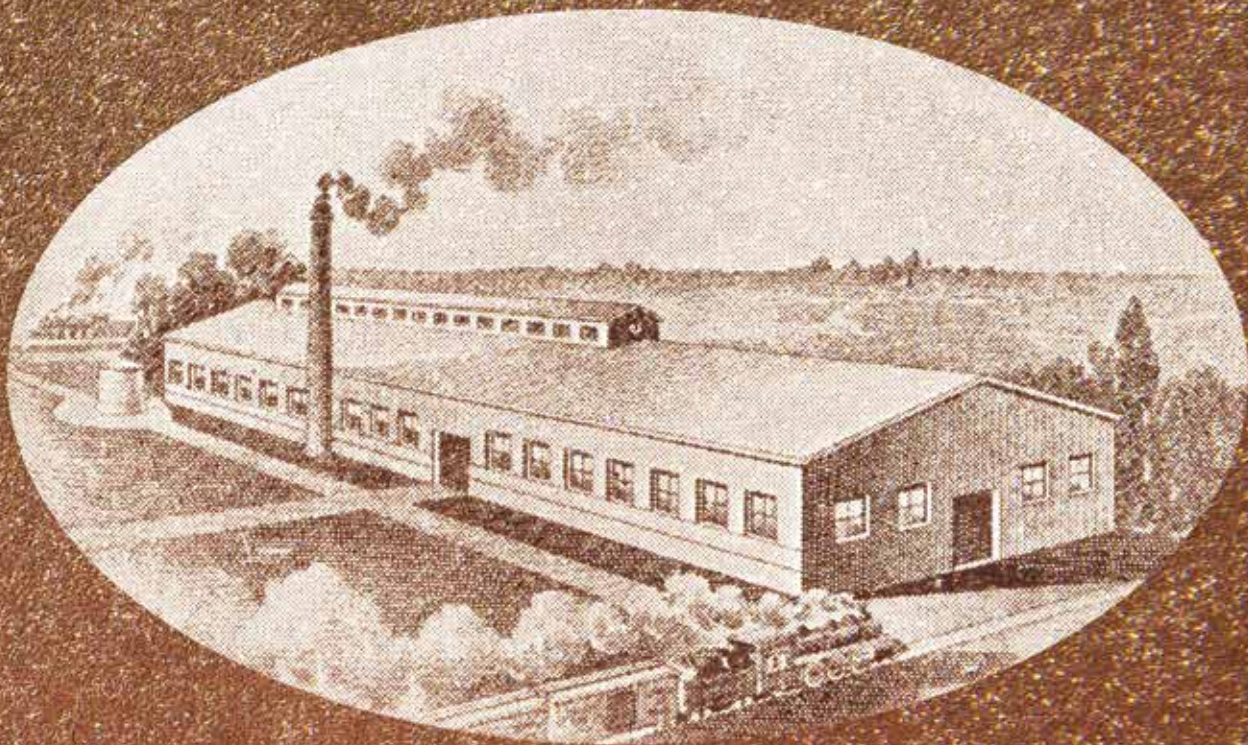

# AKRON

BRASS COMPANY

Akron Brass Company  
343 Venture Blvd. | P.O. Box 86  
Wooster, OH 44691  
Phone: 330.264.5678 | 800.228.1161  
E-Mail: [akroncare@idexcorp.com](mailto:akroncare@idexcorp.com)  
[akronbrass.com](http://akronbrass.com)

Weldon, a division of Akron Brass  
3656 Paragon Drive  
Columbus, OH 43228  
Phone: 614.529.7230 | 800.989.2718  
E-Mail: [weldoncare@idexcorp.com](mailto:weldoncare@idexcorp.com)  
[weldoninc.com](http://weldoninc.com)





# AKRON<sup>®</sup> BRASS COMPANY

**2010**

Trident Monitor



**2005**

Aquired Weldon Technologies



**2001**

Patented SaberJet Nozzle

**1999**

V-MUX Multiplex System



**2006**

Patented Diamondback Warning Light



**2004**

Aquired GFE Manufacturing

**2001**

Patented V-LED LED Technology



**1972**

Patented Swing-Out Valve

**1982**

Crash Truck Turret



**1998**

Navigator Electric Valve Controller with Flow Meter



**1994**

Assault Nozzle



**1981**

Apollo Monitor



**1961**

Patented Self Locking Valve



**1934**

Patented Vapor Spray Nozzle



**1920**

Relocated to Wooster, Ohio

**1918**

Company founded December 26, 1918 in Akron, Ohio



**1965**

Style 666 Ladder Pipe

**1946**

Introduced Akrolite aluminum alloy products

**1925**

Patented Rocker Lug Swivel



**1919**

Began production of couplings for fire hose





**2011**

SceneStar LED Scene Light



**2011**

Forestry Bumper Monitor



**2014**

Patented StreamMaster II



**2016**

UltraJet Nozzle



**2016**

Revel Scout Portable Scene Light



**1971**

Acquired Wooster Brass



**1967**

Turbojet Nozzle



**1950**

Electric Bumper Monitor



# 100 Years 1918-2018

We've been building life-safety products for a century with a standard of excellence that remains vital to what we do today. That commitment, that pride in what we do, has led us from our humble beginnings in Akron, Ohio to a position as a global leader in the firefighting equipment industry. It's been a long and storied journey of quality, consistence, and growth, leaving behind a legacy we're proud to share with you today.





### Nozzles

UltraJet® Nozzles.....	4-5
TurboJet® Nozzles.....	6-11
Assault™ Nozzles.....	12-15
SaberJet™ Nozzles.....	16-17
ProVenger® Nozzles.....	18-19
Shutoffs & Playpipes With Tips.....	20
Shutoffs & Shutoffs With Tips.....	21
Straight Tips.....	22
Discharge Pipes & Stacked Tips.....	23
Pistol Grips & Handles.....	24
Specialty Nozzles.....	25-27
Coast Guard Nozzles.....	28
Navy & Military Nozzles.....	29
Foam Nozzles.....	30
Foam Tubes.....	31-33
Master Stream Nozzles.....	34-39

### Municipal Monitors

Municipal Electric Monitors.....	40-51
Forestry Multi-Purpose Monitor.....	40
FireFox™ Monitor.....	41
Gemini™ Monitor.....	42
DeckMaster™ Monitor.....	43
Electric Riser for DeckMaster & StreamMaster™.....	43
StreamMaster II Monitor 1250 GPM.....	44
StreamMaster II Monitor 2000 GPM.....	45
Trident HFRT-10 High Flow Monitor.....	46
AeroMasterI2 Monitor.....	47
Renegade Monitor.....	48-49
Universal II Monitor Control System.....	50
Universal II Electric Monitor Optional Accessories.....	51
Municipal Portable Monitors.....	52-53
Mercury™ Quick Attack Monitor.....	53
MercuryMaster 1000™.....	53
Municipal Portable and Truck Monitors.....	54-57
Ozzie™ 911 Oscillating Monitor.....	54
Ozzie™ Master 922 Oscillating Monitor.....	54
Apollo™ Monitor.....	55
Apollo PE™ Monitor.....	56
Apollo Hi-Riser™ Monitor & Accessories.....	57
Municipal Manual Monitor.....	58-59
GP Manual Monitor.....	58
Gemini™ Monitor.....	58
Ladder Pipes.....	59
Apollo™ Single Waterway Monitors.....	59
StreamMaster™ II Manual Monitors.....	59

### Industrial Monitors

Industrial Electric Monitors.....	60-61
Severe Duty Monitor.....	61
Industrial Hydraulic Monitors.....	62
Severe Duty Monitor.....	62
Gemini Monitor.....	62
Industrial Manual Monitors.....	63-65
Omega™ XP Monitor.....	63
Omega XPV Monitor.....	63
Omega SD Monitor.....	64
Omega Monitor 1250 GPM.....	64
Aries™ Monitor.....	64
Omega Monitor 2000 GPM.....	65
Conquest™ Monitor.....	65
Storm™ Monitor.....	65
Industrial Monitor Systems.....	66-69
Conquest Electric Remote Controlled Monitor System.....	66
Storm Electric Programmable Monitor System.....	67
Genesis™ Hydraulic Monitor System.....	68
Manual Elevated Monitor.....	69
Custom Industrial Systems Applications.....	70-71
Tank Wash Down System.....	70
Large Vehicle and Heavy Equipment Washing.....	70
Crowd Control System.....	71
Industrial Accessories.....	72
Hydrant Mount.....	72
Oscillating Flange.....	72

### Turrets

Roof Turrets.....	74-75
Trident™ HFRT-10.....	74
Electric Roof Turrets.....	74
Bumper Turrets.....	76-77
FireFox™ Electric Controlled Bumper Turret.....	76
TuckAway™ Electric Bumper Turret.....	76
Ultra High Pressure Bumper Turret.....	77

### Valves

Swing-Out™ Valves.....	78-80
Swing-Out™ Valves Actuators.....	81
Swing-Out™ Valve Accessories.....	82-83
Pyrolite Swing-Out Valves.....	83
Intake Valves.....	84-85
Hydrant & Gate Valves.....	85
Pressure Relief & Drain Valves.....	86
Gate & Hydrant Valves.....	87
Wyes & Water Thief.....	88
Siamese.....	89

### Foam Equipment

Foam Eductors & Truck Systems.....	90-92
Application Chart.....	93

### Testing

Flow Test Equipment.....	94-95
Gauges.....	96
Calculators.....	97

### Weldon Vehicle Lighting & Electrical Control\*

V-MUX™ Multiplex System.....	98-109
Warning Lighting.....	110-115
Stop, Turn & Tail Lighting.....	116-121
Backup Lighting.....	122-123
Marker Lighting.....	124-126
Interior Dome Lighting.....	127-129
Utility Lighting.....	130-132
Vehicle Scene Lighting.....	133-135

\* To order or for additional information on Weldon products in this catalog please contact: WELDON at PH. 800.989.2718 (614.529.7230)

### Scene Lighting

Revel Scout®.....	136
Extenda-Lite® Light Heads.....	137-139
Revel® LED Scene Light.....	137
SceneStar® LED Scene Light.....	138
Extenda-Lite Light heads LED, Halogen & Light Head Options.....	139
Extenda-Lite Portable Base & Tripod.....	140
Extenda-Lite® Tripod Dimensions.....	141
Extenda-Lite Pull-Up & Push-Up Poles.....	142
Extenda-Lite® Swivel Base & Manual Mast.....	143
Extenda-Lite® Air Operated Pole, Brow & Recessed Lights.....	144
Extenda-Lite Ordering Information.....	145
Cord Reel Lights.....	146
Generator Light Kits.....	146-147

### Reels

Electric Rewind Cord Reels.....	148
Manual Cord Reels.....	149

### Junction Boxes

Junction Box.....	150-151
-------------------	---------

### Hand Tools

Tools & Wrenches.....	152
Wrenches & Brackets.....	153

### Fittings & Accessories

Fittings & Accessories.....	154
Hose Equipment.....	155
Specialized Tools.....	156-157

### Technical Data

Valve Guide.....	158-167
Service Kits.....	168-169
Monitor/Nozzle Compatibility Charts.....	170-172
Flow/Reach Data.....	173-177
Foam Systems.....	178-179
Threads.....	180
Metric Conversion.....	181
Theoretical Discharge & Reaction.....	182-183
Handline Nozzle Order Checklist.....	184
Flow Meter & In-Line Gauge Set-Up.....	185
Pumper Work Sheet.....	186-187
Aerial Work Sheet.....	188-189
Brush Truck Components Work Sheet.....	190-191
Style Number Index.....	192-197
Alphabetical Index.....	198-201
Customer Support.....	202



The UltraJet combines the powerful punch of a true smooth bore and the widespread protection of a full fog. This nozzle simplifies fire ground operations with intuitive functionality, the ability to change patterns without shutting down and matching flows in all patterns, so there is no need to control pressure at the pump. Whether you prefer smooth bore or fog, the UltraJet incorporates the best of both worlds so you never have to compromise.

**Features**

- Open and close the bale handle to turn the water on or off
- Twist the bumper to change the flow pattern
- Operates like a fixed orifice nozzle
- Can be used with CAFS, premixed foam, portable eductors
- Low pressure operation at 50 psi (3 bar) reduces firefighter fatigue
- Flow Range 118 to 297 gpm (447 to 1124 lpm)
- Available in 1" (25 mm), 1 5/16" (24 mm), 7/8" (22 mm) and 3/4" (19 mm) tip sizes
- Meets all NFPA requirements
- CE Certified (EN15182-2) when using 3/4" smooth bore only
- 10 year warranty
- Standard Items include: black handle, black pistol grip, spinning teeth





## 1 1/2", 2 1/2" (38, 65 mm) UltraJet Nozzles

- Flow Range 118 to 297 gpm (447 to 1124 lpm)
- Available in 1" (25 mm), 1 5/16" (24 mm), 7/8" (22 mm) and 3/4" (19 mm) tip sizes
- Meets all NFPA requirements
- CE Certified (EN15182-2) when using 3/4" smooth bore only
- 1815 Tip Kits 3/4", 7/8", 1 5/16", 1" (19, 22, 24, 25 mm)
- Standard items include: black handle, black pistol grip, spinning teeth



Style 1820

### 1820 UltraJet Nozzle

Style	Standard Inlet Sizes	Length	Weight	Tip Options	Teeth	Colored Pistol Grip and Bale Handle	Optional Inlets	Max Operating Pressure
1820	1 1/2, 2 1/2" (38, 65 mm)	12" (305 mm)	6.2 lbs (2.8 kg)	3/4", 7/8", 1 5/16", 1" (19, 22, 24, 25 mm)	Spinning Polymer	Standard is Black. Field removable pistol grip if none is desired.	BIM, BIF, Storz, BSP, JIM, ZT	230 psi (16 bar)

\* 3/4" (19 mm) tip is CE EN 15182-2 certified  
See page 173 Technical Data section for performance details



True Smooth Bore

Pressure	Tip Size			
	1" (25 mm)	1 5/16" (24 mm)	7/8" (22 mm)	3/4" (19 mm)
50 psi (3.5 bar)	210 gpm (795 lpm)	184 gpm (700 lpm)	161 gpm (609 lpm)	118 gpm (447 lpm)
75 psi (5 bar)	257 gpm (973 lpm)	226 gpm (855 lpm)	197 gpm (746 lpm)	145 gpm (549 lpm)
87 psi (6 bar) CE	277 gpm (1048 lpm)	243 gpm (924 lpm)	212 gpm (802 lpm)	156 gpm * (590 lpm)
100 psi (7 bar)	297 gpm (1124 lpm)	261 gpm (988 lpm)	227 gpm (859 lpm)	167 gpm (632 lpm)

\* 3/4" (19 mm) tip is CE EN 15182-2 certified



Narrow Fog



Full NFPA Fog











The Akron® adjustable gallonage Turbojet nozzle is unmatched in today's fire service for its flexibility and flow control. The Turbojet is a constant gallonage nozzle (flow remains the same in all patterns) with multiple flow settings for operator flow control. Use the Turbojet one time and it is easy to see why it's the nozzle of choice by firefighters worldwide.

### Features:

- Pattern Identification
- Simple to operate (quarter turn from straight stream to fog)
- Raised lug marks straight stream for limited visibility operations
- Easy to service & repair
- Standard items include: black handle, black pistol grip, black bumper, spinning teeth

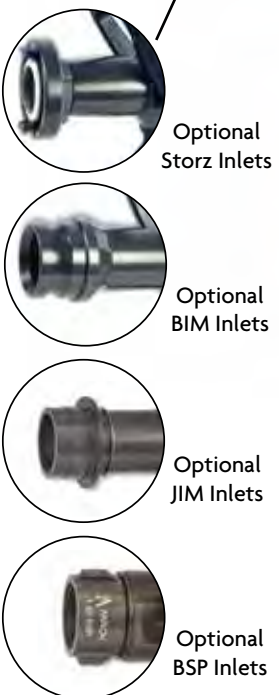

SOLAS





## 1" (25 mm) Turbojet Nozzles

- Flow setting at 100 psi (7 bar) operating pressure, 87 psi (6 bar) optional
- Raised bumper lug for straight stream pattern identification
- Compatible with Quick-Attack™ Foam Tube Style 790, See page 32
- 580 psi (40 bar) hydrostatic pressure
- Standard items include: black handle, black pistol grip, black bumper, spinning teeth

### 1701 Turbojet Nozzle

### 1702\* Turbojet Nozzle with Pistol Grip

- SOLAS & approved available (Must specify)
- FM approved (Must specify)

### 1703 Turbojet Tip with 1 1/2" (38 mm) inlet

- For use on Style 753 shutoff

### 1704 Turbojet Nozzle with Pistol Grip

- Specify either 18-30 gpm or 13-23-30 gpm settings

### 1711 Turbojet Tip with 1 1/2" (38 mm) inlet

- For use on Style 753 shutoff
- Specify either 18-30 gpm (70-115 lpm) or 13-23-30 gpm (50-90-115 lpm) settings



Style 1702



Style	Swivel Inlet	Length	Weight lbs. (kg)	Flow Settings	
				GPM	LPM
1701	1" (25 mm)	9 1/4" (206 mm)	2 1/2 (1.1 kg)	13-25-40-60	50-100-150-230
1702*	1" (25 mm)	9 1/4" (206 mm)	3 (1.4 kg)	13-25-40-60	50-100-150-230
1703	1 1/2" (38 mm)	6 5/8" (14 mm)	1 3/4 (.8 kg)	13-25-40-60	50-100-150-230
1704	1" (25 mm)	9 1/4" (206 mm)	3 (1.4 kg)	18-30** 13-23-30**	70-115* 50-90-115**
1711	1 1/2" (38 mm)	6 5/8" (14 mm)	3 3/4 (1.7 kg)	18-30** 13-23-30**	70-115* 50-90-115**

\* FM Approved Style 1702 100 psi (7 bar) pressure configuration  
See page 174 Technical Data section for performance details

## 1" (25mm) 180° Fog Turbojet Nozzles

### 1772 180° Fog Turbojet with Pistol Grip

- Flow setting at 100 psi (7 bar) standard, **87 psi (6 bar) optional**
- Fog pattern can be adjusted from straight stream to 180° for fog pattern
- SOLAS & approved (Must specify)
- Available in 2 1/2" (65 mm)
- Standard items include: black handle, black pistol grip, black bumper, spinning teeth



Style 1772

Style	Swivel Inlet	Length	Weight lbs. (kg)	Flow Settings	
				GPM	LPM
1772	1" (25 mm)	9 1/2" (241 mm)	3 (1.4 kg)	13-25-40-60	50-100-150-230

## 1 1/2" (38 mm) Turbojet Nozzles

- 100 psi (7 bar) standard, **75 psi & 86 psi (5 & 6 bar) optional**
- Compatible with Quick-Attack Foam Tube Style 792, See page 32
- Standard items include: black handle, black pistol grip, black bumper, spinning teeth

### 1714 Turbojet Tip

### 1715 Turbojet Nozzle

### 1716 Turbojet Breakpart Nozzle

- Combination of Style 1717 tip with twist shutoff + Style 2115 shutoff

### 1717 Turbojet Tip with Twist Shutoff

### 1718 Turbojet Breakpart Nozzle with Pistol Grip

- Combination of Style 1717 tip with twist shutoff + Style 2116 shutoff

### 1720\* Turbojet Nozzle with Pistol Grip

- SOLAS & approved (Must specify)
- FM approved (Must specify)



Style 1720



Style 1717

Style	Swivel Inlet	Length	Weight lbs. (kg)	Flow Settings	
				GPM	LPM
1714	1 1/2" (38 mm)	6 7/8" (165 mm)	2 1/4 (1 kg)	30-60-95-125	115-230-360-475
1715	1 1/2" (38 mm)	9 1/2" (232 mm)	3 1/2 (1.6 kg)	30-60-95-125	115-230-360-475
1716	1 1/2" (38 mm)	12" (295 mm)	3 3/4 (1.7 kg)	30-60-95-125	115-230-360-475
1717	1 1/2" (38 mm)	7 1/4" (175 mm)	2 1/4 (1 kg)	30-60-95-125	115-230-360-475
1718	1 1/2" (38 mm)	12" (295 mm)	4 1/8 (1.9 kg)	30-60-95-125	115-230-360-475
1720*	1 1/2" (38 mm)	9 1/2" (232 mm)	4 (1.8 kg)	30-60-95-125	115-230-360-475

\* FM Approved Style 1702 100 psi (7 bar) pressure configuration  
See page 174 Technical Data section for performance details



## Wide-Range Turbojet Nozzles

- Flow settings at 100 psi (7 bar) standard, **75 psi (5 bar) optional**
- Compatible with Quick-Attack Foam Tube Style 796, See page 32
- Optional 2.5" (65 mm) inlet available upon request
- Standard items include: black handle, black pistol grip, black bumper, spinning teeth



**1762 Wide-Range Turbojet Nozzle**

**1763\* Wide-Range Turbojet Nozzle with Pistol Grip**

**1764 Wide-Range Turbojet Breakpart Nozzle**

- Combination of Style 1767 tip with twist shutoff + Style 2129 shutoff

**1765 Wide-Range Turbojet Breakpart Nozzle with Pistol Grip**

- Combination of Style 1767 tip with twist shutoff + Style 2127 shutoff

**1766 Wide-Range Turbojet Tip**

**1767 Wide-Range Turbojet Tip with Twist Shutoff**



Style 1763

Style	Swivel Inlet*	Length	Weight lbs. (kg)	Flow Settings	
				GPM	LPM
1762	1 1/2" (38 mm)	11" (279 mm)	5 3/8 (2.4 kg)	30-95-125-150-200	115-360-475-550-750
1763**	1 1/2" (38 mm)	11" (279 mm)	5 3/4 (2.6 kg)	30-95-125-150-200	115-360-475-550-750
1764	1 1/2" (38 mm)	10 1/2" (267 mm)	5 1/4 (2.4 kg)	30-95-125-150-200	115-360-475-550-750
1765	1 1/2" (38 mm)	10 1/2" (267 mm)	5 9/16 (2.5 kg)	30-95-125-150-200	115-360-475-550-750
1766	1 1/2" (38 mm)	7 1/2" (190 mm)	3 1/2 (1.6 kg)	30-95-125-150-200	115-360-475-550-750
1767	1 1/2" (38 mm)	7 1/2" (190 mm)	3 1/2 (1.6 kg)	30-95-125-150-200	115-360-475-550-750

\* FM Approved Styles 1763 100 psi (7 bar) rated pressure configuration  
See page 174 Technical Data section for performance details

## Mid-Range Turbojet Nozzles

- Flow settings at 100 psi (7 bar) standard, **75 psi (5 bar) optional**
- Compatible with Quick-Attack Foam Tube Style 793, See page 32
- Optional 2.5" (65 mm) inlet available upon request
- Standard items include: black handle, black pistol grip, black bumper, spinning teeth

**1722 Mid-Range Turbojet Nozzle**

**1723 Mid-Range Turbojet Nozzle with Pistol Grip**

**1724 Mid-Range Turbojet Tip with Twist Shutoff**

**1734 Mid-Range Turbojet Breakpart Nozzle**

- Combination of Style 1724 tip with twist shutoff + Style 2129 shutoff

**1735 Mid-Range Turbojet Breakpart Nozzle with Pistol Grip**

- Combination of Style 1724 tip with twist shutoff + Style 2127 shutoff

**1737 Mid-Range Turbojet Tip**



Style 1723

Style	Swivel Inlet *	Length	Weight lbs. (kg)	Flow Settings	
				GPM	LPM
1722	1 1/2" (38 mm)	10 3/4" (273 mm)	6 (2.7 kg)	95-125-150-200	360-475-550-750
1723	1 1/2" (38 mm)	10 3/4" (273 mm)	6 1/2 (2.9 kg)	95-125-150-200	360-475-550-750
1724	1 1/2" (38 mm)	6" (152 mm)	4 1/2 (2.0 kg)	95-125-150-200	360-475-550-750
1734	1 1/2" (38 mm)	9" (229 mm)	6 1/4 (2.9 kg)	95-125-150-200	360-475-550-750
1735	1 1/2" (38 mm)	9" (229 mm)	6 5/8 (3.0 kg)	95-125-150-200	360-475-550-750
1737	1 1/2" (38 mm)	6" (152 mm)	4 1/2 (2.0 kg)	95-125-150-200	360-475-550-750

See page 174 Technical Data section for performance details



## High-Range Turbojet Nozzles

- Flow setting up to 250 gpm (950 lpm) at 100 psi (7 bar) standard, **75 psi (5 bar) optional**
- Compatible with Quick-Attack Foam Tube Style 770, See page 32
- Standard items include: black handle, black pistol grip, black bumper, spinning teeth

**1725 High-Range Turbojet Nozzle**



Style 1725

**1726 High-Range Turbojet Breakapart Nozzle**

- Combination of Style 1727 tip with twist shutoff + Style 2125 shutoff

**1727 High-Range Turbojet Tip with Twist Shutoff**

**1728 High-Range Turbojet Breakapart Nozzle**

- Combination of Style 1727 tip with twist shutoff + Style 2129 shutoff

**1733\* High-Range Turbojet Nozzle with Pistol Grip**

- SOLAS & approved (Must specify)
- FM approved (Must specify)



Style 1727



**1736 High-Range Turbojet Breakapart Nozzle with Pistol Grip**

- Combination of Style 1727 tip with twist shutoff + Style 2126 shutoff

**1738 High-Range Turbojet Breakapart Nozzle with Pistol Grip**

- Combination of Style 1727 tip with twist shutoff + Style 2127 shutoff

**1744 High-Range Turbojet Tip**

**2730 High-Range Turbojet Tip with Axial Playpipe**

- Combination of Style 1727 tip + Style 2390 Playpipe

Style	Swivel Inlet	Length	Weight lbs. (kg)	Flow Settings	
				GPM	LPM
1725	2 1/2" (65 mm)	11 1/2" (292 mm)	6 1/4 (2.8 kg)	125-150-200-250	475-550-750-950
1726	2 1/2" (65 mm)	12" (305 mm)	7 1/8 (3.2 kg)	125-150-200-250	475-550-750-950
1727	1 1/2" (38 mm)	7" (178 mm)	4 1/2 (2.0 kg)	125-150-200-250	475-550-750-950
1728	1 1/2" (38 mm)	11 3/8" (289 mm)	6 1/4 (2.8 kg)	125-150-200-250	475-550-750-950
1733*	2 1/2" (65 mm)	11 1/2" (292 mm)	6 3/4 (3.1 kg)	125-150-200-250	475-550-750-950
1736	2 1/2" (65 mm)	12 3/4" (324 mm)	7 3/8 (3.3 kg)	125-150-200-250	475-550-750-950
1738	1 1/2" (38 mm)	12 3/4" (324 mm)	6 5/8 (3.0 kg)	125-150-200-250	475-550-750-950
1744	1 1/2" (38 mm)	6" (152 mm)	4 1/2 (2.0 kg)	125-150-200-250	475-550-750-950
2730	2 1/2" (65 mm)	16 1/2" (419 mm)	10 (4.5 kg)	125-150-200-250	475-550-750-950

\* FM Approved Styles 1733 100 psi (7 bar) rated pressure configuration  
See page 174 Technical Data section for performance details

## 1 1/2" (38 mm) Industrial Turbojet Nozzles

- Brass construction
- **All Industrial Turbojets are FM approved**
- Flow setting at 100 psi (7 bar) operating pressure
- Compatible with Quick-Attack Foam Tube Style 791, See page 32
- Standard items include: black pistol grip, black bumper, spinning teeth



**3716 Industrial Turbojet Nozzle**

**3721 Industrial Turbojet Nozzle with Pistol Grip**



Style 3721

Style	Swivel Inlet	Length	Weight lbs. (kg)	Flow Settings	
				GPM	LPM
3716	1 1/2" (38 mm)	7 7/8" (200 mm)	7 1/2 (3.4 kg)	60-95-125	230-360-475
3721	1 1/2" (38 mm)	7 7/8" (200 mm)	8 3/4 (4.0 kg)	60-95-125	230-360-475

## 2 1/2" (65 mm) Industrial Turbojet Nozzle

- Brass construction
- Flow setting at 100 psi (7 bar) operating pressure
- Compatible with Quick-Attack Foam Tube Style 797, See page 32
- Standard items include: black pistol grip, black bumper, spinning teeth

**3725 Industrial Turbojet Nozzle**



Style 3725

Style	Swivel Inlet	Length	Weight lbs. (kg)	Flow Settings	
				GPM	LPM
3725	2 1/2" (65 mm)	10 1/4" (260 mm)	12 1/2 (5.7 kg)	120-150-200-250	450-550-750-950





Akron® Assault Nozzles combine quality stream performance at a variety of pressures with the simplicity of a fixed orifice. It is one of the most versatile and easy to use nozzles in today's fire service. Quality stream performance at a variety of pressures, combined with a durable and simple design.

**Features:**

- Better stream performance at pressures as low as 50 PSI (3.5 bar)
- Simplified nozzle training
- No recalibration required
- Low maintenance due to simple, durable design
- Pattern identification
- Easy to operate (quarter turn from straight stream to fog)
- Raised lug marks straight stream for limited visibility operations
- Easy to service & repair
- Standard items include: black handle, black pistol grip, black bumper, spinning teeth



Wide, dense fog delivers superior radiant heat protection...



Tight, hard-hitting straight stream for maximum reach and penetration...





## 1" (25 mm) Assault Nozzles

- Quick change pattern adjustment
- 100 psi (7 bar), **optional 87 psi (6 bar) available**
- 580 psi (40 bar) hydrostatic pressure
- Compatible with Quick-Attack Foam Tube Style 790 (4801-4805)  
Style 796 (4712-4713, 4512-4813), See page 32
- Standard items include: black handle, black pistol grip, black bumper, spinning teeth



Style 4802

- 4801 Assault Nozzle with Spinning Teeth**
- 4802\*\* Assault Nozzle with Pistol Grip and Spinning Teeth**
  - FM approved (Must specify)
- 4803 Assault Tip with 1 1/2" Inlet**
  - For use with Style 753 shutoff
- 4804 Assault Tip with Spinning Teeth**
- 4712 Assault Nozzle with Pistol Grip and Molded Teeth**
  - 60 gpm (230 lpm) flow
- 4812 Assault Nozzle with Pistol Grip and Spinning Teeth**
  - 60 gpm (230 lpm) flow
- 4713 Assault Nozzle with Molded Teeth**
  - 60 gpm (230 lpm) flow
- 4813 Assault Nozzle with Spinning Teeth**
  - 60 gpm (230 lpm) flow

Style	Swivel Inlet	Length	Weight lbs. (kg)	Flow Range	
				GPM	LPM
4801	1" (25 mm)	8 15/16" (227 mm)	2 7/8 (1.3 kg)	13, 25 or 40 *	50, 100 or 150 *
4802**	1" (25 mm)	8 15/16" (227 mm)	3 1/4 (1.5 kg)	13, 25 or 40 *	50, 100 or 150 *
4803	1 1/2" (38 mm)	5 3/4" (146 mm)	2 (.9 kg)	13, 25 or 40 *	50, 100 or 150 *
4804	1" (25 mm)	6" (152 mm)	2 (.9 kg)	13, 25 or 40 *	50, 100 or 150 *
4712	1" (25 mm)	9 5/8" (244 mm)	4 3/8 (2.0 kg)	60	230
4812	1" (25 mm)	9 5/8" (244 mm)	4 3/8 (2.0 kg)	60	230
4713	1" (25 mm)	9 5/8" (244 mm)	4 (1.8 kg)	60	230
4813	1" (25 mm)	9 5/8" (244 mm)	4 (1.8 kg)	60	230

\* Must specify flow option  
 \*\* 4802 FM Approved at 100 psi (7 bar) rated pressure  
 See page 175 Technical Data section for performance details

## 1 1/2" (38mm) Assault Nozzles

- Quick change pattern adjustment
- SPECIFY PRESSURE AND FLOW, see chart to right
- Compatible with Quick-Attack Foam Tube Style 796, See page 32
- Standard items include: black handle, black pistol grip, black bumper, spinning teeth



Style 4820



Style 4817

- 4714 Assault Tip with Molded Teeth**
- 4814 Assault Tip with Spinning Teeth**
- 4715 Assault Nozzle with Molded Teeth**
- 4815 Assault Nozzle with Spinning Teeth**
- 4716 Assault Breakapart Nozzle with Molded Teeth**
  - Combination of Style 4717 tip + Style 2115 shutoff (1" water way)
- 4816 Assault Breakapart Nozzle with Spinning Teeth**
  - Combination of Style 4817 tip + Style 2115 shutoff (1" water way)
- 4717 Assault Tip with Twist Shutoff and Molded Teeth**
- 4817 Assault Tip with Twist Shutoff and Spinning Teeth**
- 4718 Assault Breakapart Nozzle with Pistol Grip and Molded Teeth**
  - Combination of Style 4717 tip + Style 2116 shutoff
- 4818 Assault Breakapart Nozzle with Pistol Grip and Spinning Teeth**
  - Combination of Style 4817 tip with twist shutoff + Style 2116 shutoff (1" water way)
- 4819 Assault Breakapart Nozzle with Spinning Teeth**
  - Combination of Style 4817 tip with twist shutoff + Style 2129 shutoff (1 3/8" water way)
- 4720\* Assault Nozzle with Pistol Grip and Molded Teeth**
  - FM approved (Must Specify)
- 4820 Assault Nozzle with Pistol Grip and Spinning Teeth**
- 4821 Assault Breakapart Nozzle with Pistol Grip and Spinning Teeth**
  - Combination of Style 4817 tip with twist shutoff + Style 2127 shutoff

Style	Swivel Inlet	Length	Weight lbs. (kg)
4714	1 1/2" (38 mm)	6 1/2" (165 mm)	2 3/4 (1.2 kg)
4715	1 1/2" (38 mm)	8 3/8" (213 mm)	3 1/2 (1.6 kg)
4716	1 1/2" (38 mm)	10 1/2" (267 mm)	4 (1.8 kg)
4717	1 1/2" (38 mm)	6 1/2" (165 mm)	2 3/4 (1.2 kg)
4718	1 1/2" (38 mm)	11" (279 mm)	4 5/8 (2.2 kg)
4720	1 1/2" (38 mm)	8 3/8" (213 mm)	3 3/4 (1.7 kg)
4814	1 1/2" (38 mm)	6 1/2" (165 mm)	2 3/4 (1.2 kg)
4815	1 1/2" (38 mm)	8 3/8" (213 mm)	4 (1.8 kg)
4816	1 1/2" (38 mm)	10 1/2" (267 mm)	4 (1.8 kg)
4817	1 1/2" (38 mm)	6 1/2" (165 mm)	2 3/4 (1.2 kg)
4818	1 1/2" (38 mm)	11" (279 mm)	4 5/8 (2.2 kg)
4819	1 1/2" (38 mm)	10 7/8" (276 mm)	4 1/4 (1.9 kg)
4820*	1 1/2" (38 mm)	8 3/8" (213 mm)	4 1/4 (1.9 kg)
4821	1 1/2" (38 mm)	10 7/8" (276 mm)	4 1/4 (1.9 kg)

\* All pressure/flow configurations with exception of 150 gpm @75 psi (550 lpm @ 5 bar) are FM Approved  
 See page 175 Technical Data section for performance details

### Pressure & Flow Options For 1 1/2" Assault Nozzles

NOZZLE PSI	60 @ 100	95 @ 75	95 @ 100	125 @ 75	125 @ 100	150 @ 50	150 @ 75	175 @ 75	175 @ 100	200 @ 100
	Actual GPM									
50	42	78	67	102	88	150	122	106	143	124
75	52	95	82	125	108	184	150	130	175	152
100	60	110	95	144	125	212	173	150	202	175

### Pressure & Flow Options For 1 1/2" Assault Nozzles

NOZZLE BAR	230 @ 7	360 @ 5	360 @ 7	475 @ 5	475 @ 7	550 @ 3	550 @ 5	550 @ 7	660 @ 5	660 @ 7	750 @ 7
	Actual LPM										
3	159	295	254	386	333	550	462	401	541	469	534
5	197	360	310	475	409	696	550	492	660	575	655
7	230	416	360	545	475	802	655	550	765	660	750

Optional 6 bar available

Not every part number within a style number carries a certification. Contact Akron Brass customer service to verify specific nozzle certifications (example: NFPA 1964, FM, CE, SOLAS, MED).

## Mid-Range Assault Nozzles

- New flows to match a smooth bore tip
- Quick change pattern adjustment
- Specify pressure and flow, see chart below
- Compatible with Quick-Attack Foam Tube Style 796, See page 32
- Optional 2.5" (65 mm) inlet available upon request
- Standard items include: black handle, black pistol grip, black bumper, spinning teeth

- 4862 Mid-Range Assault Nozzle**
- 4863 Mid-Range Assault Nozzle with Pistol Grip**
- 4864 Mid-Range Assault Breakpart Nozzle**
  - Combination of Style 4867 tip with twist shutoff + Style 2129 shutoff
- 4865 Mid-Range Assault Breakpart Nozzle with Pistol Grip**
  - Combination of Style 4867 tip with twist shutoff + Style 2127 shutoff
- 4866 Mid-Range Assault Tip**
- 4867 Mid-Range Assault Tip with Twist Shutoff**



Style 4863

Style	Swivel Inlet*	Length	Weight lbs. (kg)
4862	1 1/2" (38 mm)	8 3/4" (222 mm)	4 (1.8 kg)
4863	1 1/2" (38 mm)	9" (222 mm)	4 1/4 (1.9 kg)
4864	1 1/2" (38 mm)	10 7/8" (276 mm)	4 1/4 (1.9 kg)
4865	1 1/2" (38 mm)	10 7/8" (276 mm)	4 5/8 (2.1 kg)
4866	1 1/2" (38 mm)	6 1/2" (165 mm)	2 3/4 (1.2 kg)
4867	1 1/2" (38 mm)	6 1/2" (165 mm)	2 3/4 (1.2 kg)

\* Optional 2.5" (65 mm) inlet available upon request  
See page 175 Technical Data section for performance details

### Pressure & Flow For Mid-Range Assault Nozzles

NOZZLE PSI	150 @ 50	150 @ 75	150 @ 100	161 @ 50	175 @ 50	175 @ 75	175 @ 100	185 @ 50	200 @ 50	200 @ 75	200 @ 100	210 @ 50	225 @ 100
	Actual GPM												
50	150	122	106	161	175	143	124	185	200	163	141	210	159
75	184	150	130	197	214	175	152	227	245	200	173	257	195
100	212	173	150	228	247	202	175	262	283	231	200	297	225

### Pressure & Flow For Mid-Range Assault Nozzles

NOZZLE BAR	550 @ 3.5	550 @ 5	550 @ 7	610 @ 3.5	660 @ 3.5	660 @ 5	660 @ 7	700 @ 3.5	750 @ 3.5	750 @ 5	750 @ 7	795 @ 3.5	850 @ 7
	Actual LPM												
3.5	550	462	401	610	660	541	469	700	750	617	534	795	602
5	696	550	492	745	810	660	575	860	927	750	655	975	738
7	802	738	550	865	435	765	660	992	1071	874	750	1125	852

\* No baffle kits available. Factory set only. Not available on 2.5" (65mm) inlets.





## High-Range Assault Nozzles

- Quick change pattern adjustment
- SPECIFY PRESSURE AND FLOW, see chart below
- Standard items include: black handle, black pistol grip, black bumper, spinning teeth



- 4822 High-Range Assault Nozzle with Spinning Teeth**
- 4722 High-Range Assault Nozzle Less Teeth**
- 4823\* High-Range Assault Nozzle with Pistol Grip and Spinning Teeth\***
  - FM approved (Must specify)
- 4824 High-Range Assault Tip with Spinning Teeth**
- 4724 High-Range Assault Tip Less Teeth**
- 4825 High-Range Assault Nozzle with Spinning Teeth**
- 4826\* High-Range Assault Nozzle with Pistol Grip and Spinning Teeth\***
  - FM approved (Must specify)
- 4726\* High-Range Assault Nozzle with Pistol Grip Less Teeth**
  - FM approved (Must specify)
- 4827 High-Range Assault Tip with Twist Shutoff and Spinning Teeth**
- 4830 High-Range Assault Tip with Axial Playpipe**
  - Combination of Style 4827 tip with twist shutoff + Style 2390 playpipe
- 4834 High-Range Assault Breakpart Nozzle with Pistol Grip**
  - Combination of Style 4827 tip with twist shutoff + Style 2127 shutoff
- 4835 High-Range Assault Breakpart Nozzle**
  - Combination Style 4827 tip with twist shutoff + Style 2129 shutoff
- 4836 High-Range Assault Breakpart Nozzle with Pistol Grip**
  - Combination of Style 4827 tip with twist shutoff + Style 2126 shutoff
- 4837\* High-Range Assault Tip with Twist Shutoff and Spinning Teeth\***
  - FM approved (Must specify)
- 4838 High-Range Assault Breakpart Nozzle**
  - Combination of Style 4827 tip with twist shutoff + Style 2125 shutoff



Style	Swivel Inlet	Length	Weight lbs. (kg)
4722	1 1/2" (38 mm)	12 11/64" (309 mm)	6 1/2 (7.5 kg)
4724	1 1/2" (38 mm)	9 3/32" (231 mm)	5 1/8 (3.2 kg)
4726	2 1/2" (65 mm)	12 11/64" (309 mm)	7 1/8 (3.2 kg)
4822	1 1/2" (38 mm)	11 1/2" (292 mm)	6 1/2 (7.5 kg)
4823*	1 1/2" (38 mm)	11 1/2" (292 mm)	7 1/4 (3.3 kg)
4824	1 1/2" (38 mm)	8 1/4" (210 mm)	5 1/4 (2.4 kg)
4825	2 1/2" (65 mm)	12 1/8" (206 mm)	7 1/8 (3.2 kg)
4826*	2 1/2" (65 mm)	12 1/8" (206 mm)	7 5/8 (3.5 kg)
4827	1 1/2" (38 mm)	8 3/4" (222 mm)	5 7/8 (2.7 kg)
4830	2 1/2" (65 mm)	16 3/4" (425 mm)	11 3/8 (5.2 kg)
4834	1 1/2" (38 mm)	13 1/2" (343 mm)	8 (3.6 kg)
4835	1 1/2" (38 mm)	13 1/8" (333 mm)	7 7/8 (3.5 kg)
4836	2 1/2" (65 mm)	14" (356 mm)	8 3/4 (4.0 kg)
4837*	2 1/2" (65 mm)	9 1/2" (241 mm)	6 1/2 (2.9 kg)
4838	2 1/2" (65 mm)	13 5/8" (346 mm)	8 1/2 (3.9 kg)

\* FM Approved Styles 4823, 4826 & 4837

See page 175 Technical Data section for performance details



### Pressure & Flow Options For High-Range Assault Nozzles

NOZZLE PSI	200 @ 75	200 @ 100	250 @ 50	250 @ 75	250 @ 100	300 @ 75	300 @ 100	350 @ 100
	Actual GPM							
50	163	141	250	204	177	245	212	247
75	200	173	306	250	217	300	260	303
100	231	200	354	289	250	346	300	350

### Pressure & Flow Options For High-Range Assault Nozzles

NOZZLE Bar	750 @ 5	750 @ 7	950 @ 3	950 @ 5	950 @ 7	1140 @ 5	1140 @ 7	1325 @ 7
	Actual LPM							
3	617	534	950	772	670	927	802	935
5	750	655	1158	950	821	1140	984	1147
7	874	750	1340	1094	950	1310	1140	1325

The patented Dual Shutoff SaberJet is a multi-purpose nozzle with both solid bore penetration and fog stream capability allowing you to flow both at the same time. The Dual Shutoff SaberJet can operate efficiently at pressures as low as 50 psi (3.5 bar) for reduced firefighter fatigue, or up to 100 psi (7 bar) for maximum flow. This versatile nozzle is well suited for multiple applications.



Style 1520

Patent 6,877,676



Fog



Solid Bore



Combination Stream

## 1 1/2" (38 mm) SaberJet DSO Nozzles

- Compatible with Quick-Attack Foam Tube Style 796, See page 32
- Standard items include: black handle, black pistol grip

### 1520 SaberJet DSO Nozzle with Pistol Grip

Style	Swivel Inlet	Length	Weight lbs. (kg)	Tip Options	Fog at 100 PSI (7 bar)	
					GPM	LPM
1520	1 1/2" (38 mm)	10 1/2" (267 mm)	5 3/8 (2.4 kg)	1/2", 5/8"* (13, 16 mm)	95	360

\* Must Specify  
See page 174 Technical Data section for performance details

## Mid-Range SaberJet DSO Nozzles

- Compatible with Quick-Attack Foam Tube Style 793, See page 32
- Standard Items include: black handle, black pistol grip

### 1523 Mid-Range SaberJet DSO Nozzle with Pistol Grip

Style	Swivel Inlet	Length	Weight lbs. (kg)	Tip Options	Fog at 100 PSI (7 bar)	
					GPM	LPM
1523	1 1/2" (38 mm)	11" (279 mm)	6 1/4 (2.8 kg)	3/4", 7/8", 15/16", 1" * (19, 22, 24, 25 mm)	135	510

\* Must Specify  
See page 174 Technical Data section for performance details

## High-Range SaberJet DSO Nozzles

- Compatible with Quick-Attack Foam Tube Style 793, See page 32
- Saberjet with 1 1/8" (29 mm) tip ideal for CAFS
- Standard items include: black handle, black pistol grip

### 1528 High-Range SaberJet DSO Nozzle with Pistol Grip

Style	Swivel Inlet	Length	Weight lbs. (kg)	Tip Options	Fog at 100 PSI (7 bar)	
					GPM	LPM
1528	2 1/2" or 1 1/2"* (65 or 38 mm)	11 5/8" (295 mm)	6 1/2 (2.9 kg)	1 1/8" (29 mm)	135	510

\* Must Specify  
See page 174 Technical Data section for performance details



# SaberJet™ Dual Shutoff Nozzles



NOZZLES

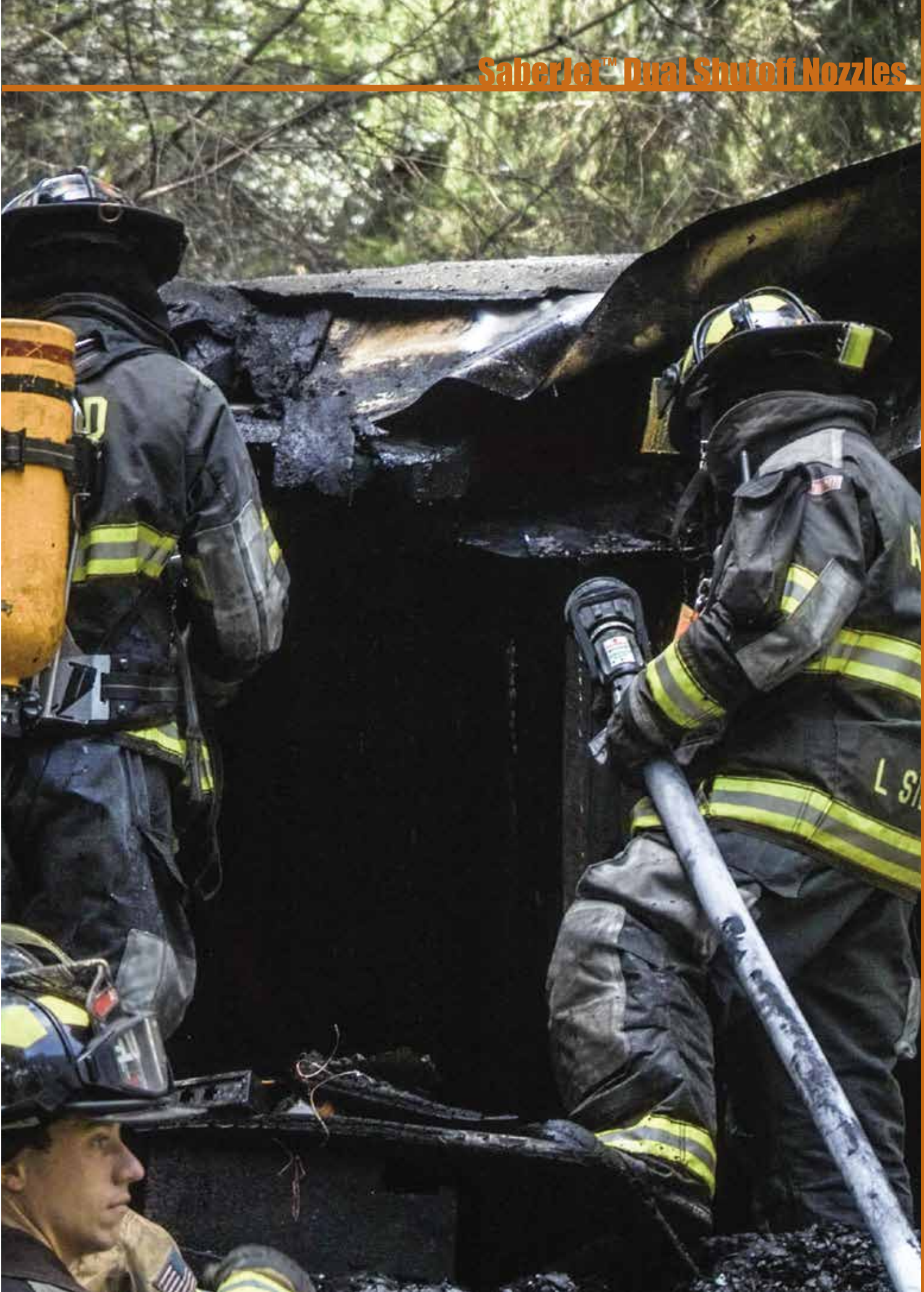









### ProVenger® Nozzles

The ProVenger family of handline nozzles combines years of design and manufacturing experience with superior performance and dependability; all at an unbeatable value. This global nozzle series can help you perform your job effectively and efficiently without sacrificing performance or your budget.

The ProVenger FG (fixed gallonage) nozzles offer a variety of pressures with the simplicity of a fixed orifice. The simple, rugged design is smooth-to-operate delivering a constant flow, hard-hitting straight stream. The ProVenger SG (selectable gallonage) nozzles are optimized from fog to straight stream with various flow settings for frontline flow control. The ProVenger SG's design gives the nozzleman flexibility to change the flow and reach depending on the situation. Low flow options, starting at 5 gpm (19 lpm), are available within the 1" (25 mm) ProVenger line. The new, lower flows aid firefighters in regulating the amount of water needed to extinguish various fires. The 1" (25 mm) nozzles are perfect for wildland and gas cooling applications.

#### Features:

- Great stream quality
- Lightweight fog and straight stream nozzle with multiple fixed or constant gallonage settings
- Raised indicator lug on the bumper for easy pattern identification
- Quickly adjust from straight stream to full fog
- Integrated control ring provides the ability to flush the nozzle without shutting down or changing stream patterns
- Only available with black pistol grip, bale handle and bumper
- Compatible with ProVenger Quick-Attack™ Foam Tubes - See page 32
- Removable pistol grip
- Standard items include: black handle, black pistol grip, black bumper, spinning teeth



### 1" (25 mm) ProVenger Nozzles

**1602 ProVenger SG Nozzle with Pistol Grip and Spinning Teeth**

### 1 1/2" (38 mm) ProVenger Nozzles

• FM approved (Must specify)

**1616 ProVenger SG Nozzle with Pistol Grip and Spinning Teeth**

**4116 ProVenger FG Nozzle with Pistol Grip & Spinning Teeth**



Optional Storz Inlets



Optional BIM Inlets



Optional JIM Inlets



Optional BSP Inlets

Style	Gallonage	Pistol Grip	Swivel Inlet	Length	Weight lbs. (kg)	Flow Setting**		Max Operating Pressure
						GPM	LPM	
1602	Selectable	YES	1" (25.4 mm)	9 1/4" (235 mm)	3 (1.4 kg)	5-10-20-40 @ 75, 87 or 100 psi 12-23-34-53 @ 87 psi	19-40-75-150 @ 5, 6 or 7 bar 45-85-130-200 @ 6 bar	230 psi (16 bar)
1616*	Selectable	YES	1 1/2" or 2 1/2" (38 or 65 mm)	10 1/2" (267 mm)	4.3 (2 kg)	30-60-95-125-150 @ 75, 87 or 100 psi	115-230-360-475-550 @ 5, 6 or 7 bar	230 psi (16 bar)
4116*	Fixed	YES	1 1/2" or 2 1/2" (38 or 65 mm)	10 1/2" (267 mm)	4 (1.8 kg)	60-95-125-150 @ 75, 87 or 100psi	230-360-475-550 @ 5, 6, or 7 bar	230 psi (16 bar)

\* FM Approved (Must specify)  
See page 173 Technical Data section for performance details

## Axial Playpipes With Tips

Combination of a playpipe with plain, stacked or threaded tips for direct connection to a 2 1/2" (65 mm) hose line. Playpipes have a shutoff between the handle and a full-time swivel base for easy handling.

- Standard Item Include: black handle



Style 2393

Style	Finish	Length	Weight lbs. (kg)	Orifices		Threads			Combination			Shutoff Waterway Size
				Standard	Optional	Base	Top Shutoff	Top Tip	Play Pipe	Shutoff	Tip	
2393	Pyrolite	18 3/8" (467 mm)	6 5/8 (7.5 kg)	1", 1 1/8", 1 1/4"	-	2 1/2" (65 mm)	1 1/2" (38 mm)	-	2390	-	1420	1 3/8" (35 mm)

## Playpipes With Shutoff

Rugged compact design for better balance and durability with dual handle stops on the shutoff.

- Standard Item Include: black handle



Style 2390

Style	Length	Weight lbs. (kg)	Threads		Shutoff Waterway Size	Finish
			Inlet Female	Outlet Male		
2390	10 1/2" (267 mm)	5 1/2 (2.5 kg)	2 1/2" (65 mm)	1 1/2" (38 mm)	1 3/8" (35 mm)	Pyrolite®

## Brass Shutoff

Full-time restricted swivel base ensures the handle can be positioned for easy operation

- Standard Item Include: black handle



Style 1125

Style	Length	Weight lbs. (kg)	Threads		Shutoff Waterway Size	Finish
			Inlet Female	Outlet Male		
1125	4 3/4" (121 mm)	4 1/4 (1.9 kg)	1 1/2" (38 mm)	1 1/2" (38 mm)	1 3/8" (35 mm)	Cast





## Saber™ Shutoffs With Integral Tip

Lightweight ball shutoff with an integral straight bore tip.

- Standard items Include: black handle, black pistol grip



Style 2431

Style	Pistol Grip	Finish	Length	Weight lbs. (kg)	Orifices	Threads		Shutoff Waterway Size
						Inlet	Outlet	
2430	-	Pyrolite	6 7/8" (175 mm)	2 1/4 (1.0 kg)	7/8", 15/16", 1", 1 1/8", 1 1/4"	1 1/2" (38 mm)	1 1/2" (38 mm)	1 3/8" (29 mm)
2431	YES	Pyrolite	6 7/8" (175 mm)	3 (1.4 kg)	7/8", 15/16", 1", 1 1/8", 1 1/4"	1 1/2" (38 mm)	1 1/2" (38 mm)	1 3/8" (29 mm)
2432	-	Pyrolite	7 3/8" (187 mm)	3 (1.4 kg)	7/8", 15/16", 1", 1 1/8", 1 1/4"	2 1/2" (65 mm)	1 1/2" (38 mm)	1 3/8" (29 mm)
2433	YES	Pyrolite	7 3/8" (187 mm)	3 1/2 (1.6 kg)	7/8", 15/16", 1", 1 1/8", 1 1/4"	2 1/2" (65 mm)	1 1/2" (38 mm)	1 3/8" (29 mm)

## Pyrolite Shutoffs

Tough, lightweight ball shutoffs with a full-time swivel base ensures the handle can be positioned for easy operation.

- Standard items include: black handle, black pistol grip

Shutoff Waterway Size 1" (For Flows Less Than 150 GPM)							
Style	Pistol Grip	Finish	Length	Weight lbs. (kg)	Threads		Shutoff Waterway Size
					Inlet Female	Outlet Male	
2101	-	Pyrolite	4 1/4" (108 mm)	1 1/4 (.6 kg)	1" (25 mm)	1" (25 mm)	1" (25 mm)
2102	YES	Pyrolite	4 1/4" (108 mm)	2 (.9 kg)	1" (25 mm)	1" (25 mm)	1" (25 mm)
2108	YES	Pyrolite	4 1/2" (114 mm)	1 5/8 (.7 kg)	1" (25 mm)	1 1/2" (38 mm)	1" (25 mm)
2115	-	Pyrolite	4 1/2" (114 mm)	1 1/2 (.7 kg)	1 1/2" (38 mm)	1 1/2" (38 mm)	1" (25 mm)
2116	YES	Pyrolite	4 1/2" (114 mm)	1 7/8 (.9 kg)	1 1/2" (38 mm)	1 1/2" (38 mm)	1" (25 mm)

Shutoff Waterway Size 1 3/8" & 2" (For Flows More Than 150 GPM)							
Style	Pistol Grip	Finish	Length	Weight lbs. (kg)	Threads		Shutoff Waterway Size
					Inlet Female	Outlet Male	
2125	-	Pyrolite	6" (152 mm)	2 5/8 (1.2 kg)	2 1/2" (65 mm)	1 1/2" (38 mm)	1 3/8" (35 mm)
2126	YES	Pyrolite	6" (152 mm)	2 7/8 (1.3 kg)	2 1/2" (65 mm)	1 1/2" (38 mm)	1 3/8" (35 mm)
2127	YES	Pyrolite	4 7/8" (124 mm)	2 1/8 (1.0 kg)	1 1/2" (38 mm)	1 1/2" (38 mm)	1 3/8" (35 mm)
2129	-	Pyrolite	4 7/8" (124 mm)	1 3/4 (.8 kg)	1 1/2" (38 mm)	1 1/2" (38 mm)	1 3/8" (35 mm)
2130	-	Pyrolite	6 3/8" (162 mm)	4 1/4 (1.9 kg)	2 1/2" (65 mm)	2 1/2" (65 mm)	2" (51 mm)



Style 2126  
Shutoff with Pistol Grip & Handle



Style 2129

## Pyrolite® Shutoffs With Dual Stacked Tips

Lightweight ball shutoff with Style 439 tips for use where a fog nozzle is not required. Base tip has a female thread on the outlet for added protection and durability.

- Standard items include: black handle, black pistol grip

Style	Pistol Grip	Finish	Length	Weight lbs. (kg)	Inlet	Orifices	Combination		Shutoff Waterway Size
							Shutoff	Tip	
1440	-	Pyrolite	10 3/8" (264 mm)	2 1/2 (1.3 kg)	1 1/2" (38 mm)	15/16" x 1/2" (24 x 13 mm)	2129	439	1 3/8" (35 mm)
1441	YES	Pyrolite	10 3/8" (264 mm)	2 7/8 (1.3 kg)	1 1/2" (38 mm)	15/16" x 1/2" (24 x 13 mm)	2127	439	1 3/8" (35 mm)
1442	-	Pyrolite	11 1/2" (292 mm)	3 3/8 (1.5 kg)	2 1/2" (65 mm)	1 1/8" x 1/2" (29 x 13 mm)	2125	439	1 3/8" (35 mm)
1443	YES	Pyrolite	11 1/2" (292 mm)	4 5/8 (2.1 kg)	2 1/2" (65 mm)	1 1/8" x 1/2" (29 x 13 mm)	2126	439	1 3/8" (35 mm)



Style 1440

## Blitz Tips

Pyrolite shutoff with pistol grip and straight tip for high volume low pressure operation. Nearly 400 gpm (1500 lpm) at 50 psi (3.5 bar).

- Standard items include: black handle, black pistol grip

Style	Pistol Grip	Finish	Length	Weight lbs. (kg)	Standard Orifices	Threads		Combination		Shutoff Waterway Size
						Inlet	Tip	Shutoff	Tip	
1445	YES	Pyrolite	10" (254 mm)	3 3/8 (1.5 kg)	1 3/8" (35 mm)	1 1/2" (38 mm)	1 1/2" (38 mm)	2127	1499	1 3/8" (35 mm)
1446	YES	Pyrolite	10 5/8" (270 mm)	4 5/8 (2.1 kg)	1 3/8" (35 mm)	2 1/2" (65 mm)	1 1/2" (38 mm)	2126	1499	1 3/8" (35 mm)



Style 1446

## Straight Tips

- 416**    **1 1/2" (38 mm) Thread Tip**
- Now available in Pyrolite®
  - Intergrated Thread Protector
  - Protective rubber bumper
  - 1 1/8" (28.6 mm) standard orifice (see chart below for orifice options)
- 417**    **1 1/2" (38 mm) Plain Tip**
- Protective rubber bumper
  - 1 1/8" (28.6 mm) standard orifice (see chart below for orifice options)
- 438**    **1 1/2" (38 mm) Plain Tip**
- Protective rubber bumper
  - 1/2" (13 mm) standard orifice (see chart below for orifice options)
- 489**    **Plain Deluge Tip**
- 2 1/2" (65 mm) Inlet
    - 1 1/2" (38 mm) standard orifice (see chart below for orifice options)
  - 3" (75 mm) Inlet
    - 2" (52 mm) standard orifice (see chart below for orifice options)
- 1410**    **1" (25 mm) Plain Tip**
- 3/8" (9.5 mm) standard orifice (see chart below for orifice options)
- 1417**    **1 1/2" (38 mm) Plain Tip**
- 7/8" (22 mm) standard orifice (see chart below for orifice options)
- 1499**    **1 1/2" (38 mm) Plain Tip**
- 1 3/8" (35 mm) standard orifice (see chart below for orifice options)



Style	Length	Weight lbs. (kg)	Orifices		Threads	Finish
			Standard	Optional		
416	6" (152 mm)	2 3/4 (1.2 kg)	1 1/8" (29 mm)	3/4", 7/8", 1", 1 1/4" (19, 22, 25, 32 mm)	1 1/2" X 1 1/2" (38 x 38 mm)	Brass, Chrome or Pyrolite
417	6" (152 mm)	2 (.9 kg)	1 1/8" (29 mm)	3/4", 7/8", 1", 1 1/4" (19, 22, 25, 32 mm)	1 1/2" (38 mm)	Brass or Chrome
438	4 3/8" (111 mm)	1 1/4 (.6 kg)	1/2" (13 mm)	3/8", 5/8" (9.5, 16 mm)	1 1/2" (38 mm)	Brass
489	9" (229 mm)	3-brass (1.4 kg) 1-alum. (.5 kg)	1 1/2" (38 mm)	7/8", 15/16", 1", 1 1/8", 1 1/4", 1 3/8", 1 3/4", 2" (22, 24, 25, 29, 32, 35, 44, 50 mm)	2 1/2" (65 mm)	Brass or Aluminum
489	10 1/2" (267 mm)	5-brass (2.3 kg) 1 3/4-alum. (.8 kg)	2" (50 mm)	1 3/4", 2 1/4", 2 1/2" (44, 57, 65 mm)	3" NPSH (75 mm)	Brass or Aluminum
1410	4 1/2" (114 mm)	3/8 (.2 kg)	3/8" (10 mm)	5/8" (16 mm)	1" (25 mm)	Pyrolite
1417	3 3/4" (95 mm)	3/4 (.3 kg)	7/8" (22 mm)	3/8", 1/2", 5/8", 3/4", 15/16", 1", 1 1/8", 1 1/4" ◊ (9.5, 13, 16, 19, 24, 25, 29, 32 mm)	1 1/2" (38 mm)	Pyrolite
1499*	5" (127 mm)	3/4 (.3 kg)	1 3/8" (35 mm)	7/8", 15/16", 1", 1 1/8", 1 3/16", 1 1/4" (22, 24, 25, 29, 30, 32 mm)	1 1/2" NH (38 mm)	Pyrolite

\* Available with set screw for permanent attachment - Must Specify  
 ◊ 3/8" tip NH thread only



# Discharge Pipes & Stacked Tips

## Discharge Pipes

Designed with built-in fins to maximize reach on any monitor.

- Cast, chrome or Pyrolite®



Style 3488

Style	Length	Weight lbs. (kg)		Size
		Brass	Pyrolite	
3488	10 1/2" (267 mm)	6 3/4 (3.1 kg)	2 1/2 (1.3 kg)	2 1/2" X 2 1/2" (65 x 65 mm)
3488	11 1/2" (292 mm)	9 1/4 (4.2 kg)	-	3 1/2" X 2 1/2" (89 x 65 mm)
3488	14 1/2" (368 mm)	-	3 (1.4 kg)	3 1/2" X 2 1/2" (89 x 65 mm)
3488	10 1/2" (267 mm)	9 5/8 (4.4 kg)	-	3 1/2" NPSH X 3" NPSH (89 x 75 mm)

## Mini Stream Shapers

- One piece extruded aluminum for extreme durability
- Tapered fins for improved stream performance
- 2 1/2" (52 mm) and 3 1/2" (89 mm) shapers have offset fins for improved stream performance.
- Style 485 is in cast brass



Style 485



Style 3485

Style	Size	Length	Weight lbs. (kg)
3485	1 1/2" x 1 1/2" (38 x 38 mm)	1 7/8" (48 mm)	1/4 (1 kg)
	2 1/2" x 2 1/2" (65 x 65 mm)	4" (100 mm)	1 1/4 (.6 kg)
	3 1/2" x 3 1/2" (89 x 89 mm)	4" (100 mm)	2 (.9 kg)
485*	2 1/2" x 2 1/2" (65 x 65 mm)*	4" (100 mm)	3.7 (1.7 kg)

\* 1 1/2" X 1 1/2" also available (38 mm x 38 mm)

## Stacked Tips

Style	Finish	Length	Weight lbs. (kg)	Orifices		Base	Threads	
				Standard	Optional		Middle	Top
439	Pyrolite	6 5/8" (168 mm)	3/4 (.3 kg)	15/16" X 1 1/2" or 1 1/8" X 1 1/2" (24 x 13 or 29 x 13 mm)	-	1 1/2" (38 mm)	-	1" NH (25 mm)
1420	Pyrolite	8 1/4" (210 mm)	1 1/8 (.5 kg)	1" X 1 1/8" X 1 1/4" (25 x 29 x 32 mm)	-	1 1/2" (38 mm)	1 1/2" NH (38 mm)	1 1/4" NPSH (32 mm)
2420	Pyrolite	9 5/8" (244 mm)	1 1/2 (.7 kg)	1" X 1 1/4" X 1 3/8" (25 x 32 x 35 mm)	1" X 1 1/4" X 1 1/2" (25 x 32 x 38 mm) 1" X 1 1/8" X 1 1/4" (25 x 29 x 32 mm)	2 1/2" (65 mm)	1 1/2" NH (38 mm)	1 1/4" NPSH (32 mm)
2498	Chrome*	15 1/2" (394 mm)	2 1/2 (1.1 kg)	1 1/2" X 1 3/4" X 2" (38 x 44 x 50 mm)	1 1/4" X 1 1/2" X 2" (32 x 38 x 50 mm)	2 1/2" (65 mm)	2" NH (50 mm)	1 1/2" NH (38 mm)
2499	Pyrolite	16 7/8" (429 mm)	2 7/8 (1.3 kg)	1 3/8" X 1 1/2" X 1 3/4" X 2" (35 x 38 x 44 x 50 mm)	-	2 1/2" (65 mm)	2" NH Underwriters (50 mm)	1 1/2" NH (38 mm)
3499	Pyrolite	19 1/2" (495 mm)	7 1/2 (3.4 kg)	2 1/4" X 2 1/2" X 2 3/4"*** (57 x 65 x 70 mm)	2" X 2 1/4" X 2 1/2" (51 x 57 x 65 mm)	3 1/2" NH (89 mm)	2 1/2" NH (65 mm)	2 1/2" NH (65 mm)

\* Chrome plated Aluminum

\*\*Top Tip with 2 1/2" NH Male Thread



Style 439  
Dual Stacked Tips



Style 1420  
Triple Stacked Tips



Style 2420  
Triple Stacked Tips



2498  
Triple Stacked Deluge Tips



Style 3499  
Master Stacked Tips  
- Use with Style 3485 3 1/2" Mini Stream Shaper



Style 2499  
Quad Stacked Deluge Tips

## Pistol Grips & Handles

### Pistol Grip:

This unique design features comfort pad added to the pistol grip providing extra cushioning to the hand for reduced muscle fatigue.

### Handle:

- Handling – The handle features contoured corners and a unique curve upward when in the open position providing improved grip and easier access to shut off the nozzle.
- Storage space – The handles curved forward design streamlines the nozzle while reducing the overall height taking up less crosslay and cabinet space.
- Strength – The "I Beam" design accompanied by larger trunnion hubs provides superior strength and durability.

### Pistol Grips

Color	Part Number
Black (Standard)	718233
Gray	718240
Red	718236
Orange	718238
Purple	718279
Blue	718237
White	718234
Green	718239
Yellow	718235



### Bale Handle Options Including Roll Pins

Color	Part Number	
	1" Turbojet® 1 1/2" Turbojet 1" Assault™	Wide-Range Turbojet Mid-Range Turbojet High-Range Turbojet Dual Shutoff Saberjets™ 1.5" Assaults Mid-Range Assaults High-Range Assaults Ultrajets
Black (Standard)	90010001	90020001
Gray	90010004	90020004
Red	90010003	90020003
Orange	90010006	90020006
Purple	90010011	90020011
Blue	90010007	90020007
White	90010008	90020008
Green	90010005	90020005
Yellow	90010002	90020002
Metal Bale Option	-	122551



### Metal Bale

Allows 1 1/2" (38 mm) & 1 3/4" (44 mm) hose to pass through for compact hose lays

### Colored Bumpers

- Black (Standard)
- Green
- Red
- Blue
- Yellow
- Gray
- Orange
- White



NOTE: Unless specified, nozzles will be shipped with Black Handles, Bumpers and Pistol Grips. When ordering replacements, specify nozzle style number. Contact Customer Care for additional information.





### Forestry/Wildland Nozzles

Small lightweight nozzles designed for the rugged simplicity needed for forestry/wildland applications.

#### 1030 Forestry Nozzle

A dual flow adjustable pattern nozzle with a simple twist operation allows you to switch to the following settings:

- 100 psi (7 bar) setting
- Off
- Low flow straight stream
- Low flow narrow fog
- High flow straight stream
- High flow fog

#### 1700 Bush Nozzle

- 100 psi (7 bar) setting
- A three flow setting adjustable pattern nozzle with the flow control and off settings
- Easy to operate control ring
- Adjustable pattern from straight stream to fog at any flow.
- Quarter turn, quick action pattern change
- 10 year warranty
- NFPA compliant
- Maximum operating pressure 250 psi (17.5 bar)



Style 1700



Style 1030

Style	Inlet	Length	Weight lbs. (kg)	Flow at 100 PSI	
				GPM	LPM
1030	1" (25 mm)	4" (102 mm)	1/2 (.2 kg)	10 - 30	38 - 115
1700	1" (25 mm)	6 3/8" (153 mm)	2 (.9 kg)	Mop (8)-15-30	Mop (30)-60-115

### Zero Torque™

The Zero Torque (ZT) nozzle is the first nozzle specifically designed with ergonomics, handling, control and reduced firefighter fatigue in mind. The ZT naturally keeps the nozzle out in front of the firefighter to allow for easier operation and provide better control. In addition the pistol grip and inlet swivel are positioned to eliminate the reaction force torque found in all conventional pistol grip designs. Conventional pistol grip nozzles are held at a position 3 1/2" to 4" (89 to 100 mm) below the center line of discharge, creating a natural torque which must be resisted by the firefighter. The ZT is positioned to eliminate the torque, leaving only the straight reaction force for the firefighter to resist.

The ZT is available on any 1 1/2" (38 mm), Mid-Range, Wide-Range, and 2 1/2" (65 mm) Turbojet, SaberJet, Assault or UltraJet nozzle. It is also available on Style 2125, 2129, 2430 and 2432 shutoffs with or without integrated stream shaper.

To order, simply specify your choice of 1 1/2" (38 mm), Wide-Range, Mid-Range, or 2 1/2" (65 mm) non-pistol grip Style and add "with ZT".

For example: Style 1715 w/ZT, or Style 4862 w/ZT.

- Standard items include: black pistol grip

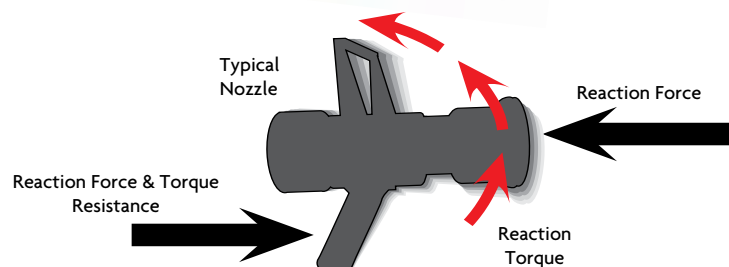

## High Pressure Trigger Shutoff

This is a compact, lightweight, easy-to-use shutoff for high pressure applications. The ergonomically designed trigger shutoff automatically shuts off flow when released. Designed for high pressure applications up to 700 psi (48 bar) hydrostatic pressure. For use with Turbojet® and Assault™ Tips: 1703, 1711, 4803.

- 753 High Pressure Trigger Shutoff**
- 1" (25 mm) swivel inlet x 1 1/2" (38 mm) male



Style 753  
Shown with Style 1703

Style	Swivel Inlet	Length	Weight lbs. (kg)	Flow Range	
				GPM	LPM
753	1" (25 mm)	7 3/4" (197 mm)	4 (1.8 kg)	13-30	50-115

## Ultra High Pressure Handline Nozzle

The Ultra High Pressure handline nozzle is designed to operate at pressures as high as 1500 psi (103 bar). It is the perfect nozzle for delivering ultra-fine water droplets at high velocity. In addition, this nozzle handles these pressures with a bale shutoff that opens and closes with no more force than your standard firefighting nozzle.

- 4808 Ultra High Pressure Handline Nozzle**
- Swivel: 1" (25 mm) NH Inlet
  - Length: 7.5" (190.5 mm)
  - Weight: 3.2 lbs (1.45 kg)
  - Maximum Pressure: 1500 psi (103 bar) - Must Specify
  - Flow Range: 15 - 30 GPM (75 - 115 LPM) - Must Specify
  - Standard items include: black handle, black pistol grip, black bumper



Style 4808

Style	Swivel Inlet	Length	Weight lbs. (kg)	Flow Range	
				GPM	LPM
4808	1" (25 mm)	7 5/8" (194 mm)	3.2 (1.45 kg)	15-30*	75-115

\* Must Specify

## Brass Fog Nozzles

A combination fog and straight stream nozzle designed for efficiency with foam or water on offshore rigs and in industrial applications.

- Molded teeth
- Constant gallonage in fog and straight stream patterns
- Flush without shutting down
- Repair kits available
- Compatible with 794 Quick Attack™ Foam Tube for Styles 3015-3021, see page 32
- Standard items include: black handle, black pistol grip, black bumper



Style 3019

Style	Inlet	Length	Weight lbs. (kg)	Flow At 100 Psi		Pistol Grip
				GPM	LPM	
3015	1 1/2" (38 mm)	8 5/8" (219 mm)	7 1/8 (3.2 kg)	95	360	-
3016	1 1/2" (38 mm)	8 5/8" (219 mm)	7 1/8 (3.2 kg)	125	475	-
3019	1 1/2" (38 mm)	8 5/8" (219 mm)	7 3/4 (3.5 kg)	95	360	YES
3021	1 1/2" (38 mm)	8 5/8" (219 mm)	7 3/4 (3.5 kg)	125	475	YES
3025	2 1/2" (65 mm)	10" (254 mm)	13 (5.9 kg)	250	950	-



## Brass Cellar Nozzles

- For attacking fires in hard-to-reach places
- Ball bearing revolving action

- 535 2 1/2" (65 mm) Cellar Nozzle**
- 9 variable angle orifices: (3) 3/8" (9.5 mm) and (6) 13/32" (10.3 mm)
  - Meets Insurance Services Office (ISO) requirements
- 536 1 1/2" (38 mm) Cellar Nozzle**
- 6 variable angle orifices: (3) 1/4" (6.3 mm) and (3) 5/16" (8.0 mm)



Style 536

Style	Inlet	Length	Weight lbs. (kg)	Flow at 100 PSI	
				GPM	LPM
535	2 1/2" (65 mm)	5 1/8" (130 mm)	4 1/2 (2.0 kg)	250	950
536	1 1/2" (38 mm)	3 1/2" (89 mm)	4 1/4 (1.9 kg)	* 95	* 360

\* At 50 psi

## Cellar Nozzle Applicator

Akron Brass offers a unique 90° Applicator with an integral Shut Off Valve and a Cellar Nozzle with foldable legs. This unit is designed to free up the firefighter when confronted with situations requiring an overhead attack. Once this applicator is in place, the firefighter is available to perform other duties.

- Inlet: 2.5" (65 mm) Swivel
- Integral Ball Shut Off
- 90° bend for overhead applications
- Folding Legs
- Revolving Nozzle
- Flow: 500 gpm @ 50 psi (1900 lpm @ 3.5 bar)
- Spray Pattern Diameter: 40' (12 m) at 50 psi (3.5 bar)
- Lightweight Pyrolite® construction
- Overall length: 36.5" (927 mm)
- Weight: 18.6 lbs (8.4 kg)



Style 538  
Shown with  
Legs Open

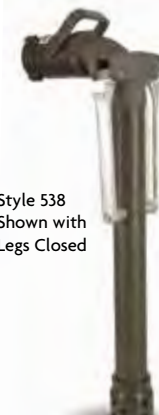

Style 538  
Shown with  
Legs Closed

## Piercing Applicator

Use a sledge hammer to drive the Piercing Applicator through concrete block, cars, mobile homes, etc. It is designed to get water or foam into hidden trouble spots. The driving button and point are made of hardened tool steel with impinging jets for a dense fog pattern. Plus, it's compatible with Class A and B foams.



Style 1088

- 1088 Piercing Applicator**
- Specify 3' or 6' length (914 mm or 1828 mm)

Style	Inlet	Length	Weight lbs. (kg)	Flow at 100 PSI	
				GPM	LPM
1088	1 1/2" (38 mm)	3' (914 mm)	11 (5.0 kg)	125	475

## Fog Applicator

- 2055 Fog Applicator**
- Designed for those hard-to-reach areas such as tank cars
  - Compatible with Class A and Class B foams (Not recommended for foam requiring air-aspiration, i.e. protein and alcohol types)
  - Lightweight aluminum tubing
  - Includes Style 1048: Coast Guard Fog Head

Available in the following lengths (Must specify):

- 4' (1.2 m) with 60° Bend
- 6' (1.8 m) with 90° Bend
- 10' (3 m) with 90° Bend

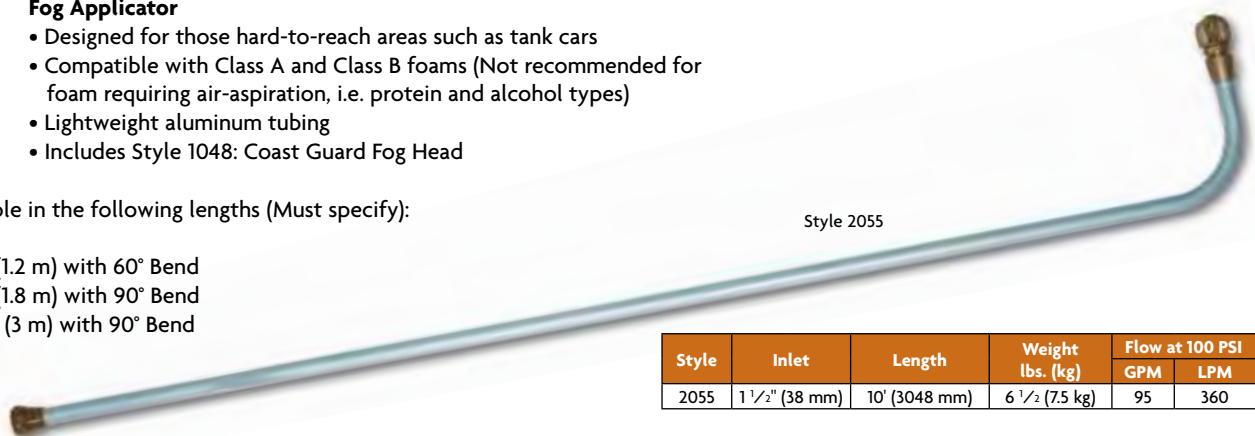

Style 2055

Style	Inlet	Length	Weight lbs. (kg)	Flow at 100 PSI	
				GPM	LPM
2055	1 1/2" (38 mm)	10' (3048 mm)	6 1/2 (7.5 kg)	95	360

## Coast Guard Shipboard Vari-Nozzles

A combination fog and straight stream nozzle designed for more efficiency with AFFF or water on-board ships. Compatible with Style 794 Quick Attack Foam Tube, see page 32.

- Brass construction
- Low friction ball and dual seats for smooth operation
- Molded teeth
- Constant gallonage in fog and straight stream patterns
- Flush without shutting down
- Standard items include: black handle, black bumper



Style 3022

Style	Length	Weight lbs. (kg)	Inlet Size	Approval Number	Pistol Grip	Flow at 100 PSI	
						GPM	LPM
3020	8 5/8" (219 mm)	7 3/4 (3.5 kg)	1 1/2" NH (38 mm)	162.027/15/0	YES	95	360
3022	8 5/8" (219 mm)	7 1/8 (3.2 kg)	1 1/2" NH (38 mm)	162.027/16/0	-	95	360

## Coast Guard Nozzles With Fog Tips

Style	Length	Weight lbs. (kg)	Inlet Size	Orifice	Fog Head/Tip	Approval Number	Flow at 100 PSI	
							GPM	LPM
2032 (CG-15)	10 1/4" (260 mm)	9 (4.1 kg)	1 1/2" NH (38 mm)	5/8" ** (16 mm)	2033	162.027/09/0	* 55	* 208
2046 (CG-25)	11 1/2" (292 mm)	14 1/2 (6.6 kg)	2 1/2" NH (65 mm)	15/16" *** (25 mm)	2047	162.027/10/0	* 106	* 401

\* Fog flow only  
 \*\* 90 gpm at 100 psi  
 \*\*\* 250 gpm at 100 psi



Style 2046 Including Style 2047 Fog Tip and Chain

## Brass Coast Guard Fog Tips

- 2033** 1 1/2" (38 mm) Fog Tip with Chain
- Fits Style 2032 CG-15 Nozzle
  - Approval no. 162.027/09/0
- 2047** 2 1/2" (65 mm) Fog Tip with Chain
- Fits Style 2046 CG-25 Nozzle
  - Approval no. 162.027/10/0



Style 2033

## Coast Guard Applicators With Fog Heads

Applicators with stainless steel tubing to Coast Guard specifications. Improved head and end connectors for increased strength and durability.

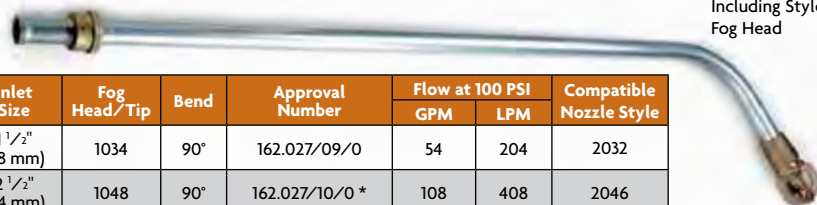

Style 2415 Including Style 1034 Fog Head

Style	Length	Weight lbs. (kg)	Inlet Size	Fog Head/Tip	Bend	Approval Number	Flow at 100 PSI		Compatible Nozzle Style
							GPM	LPM	
2015	10' (3048 mm)	9 1/4 (4.2 kg)	1 1/2" (38 mm)	1034	90°	162.027/09/0	54	204	2032
2225	6, 10', 12' (1827, 3048, 3657.6 mm)	↑ 15 3/4 (7.1 kg)	2 1/2" (64 mm)	1048	90°	162.027/10/0 *	108	408	2046
2415	4' (1219.2 mm)	5 (2.3 kg)	1 1/2" (38 mm)	1034	60°	162.027/09/0	54	204	2032

↑ 12' length  
 \* 12' only

## Brass Coast Guard Fog Heads

- 1034** 1 1/2" (38 mm) Fog Head
- Fits Style 2415 and 2015 Applicators
  - Approval no. 162.027/09/0
  - 1" NPT
- 1048** 2 1/2" (65 mm) Fog Head
- Fits Style 2225 Applicator and Style 2055 Fog Applicator
  - Approval no. 162.027/10/0
  - 1 1/2" NPT



Style 1034





### Brass Navy Shipboard Vari-Nozzles

- Brass construction
- Self-adjusting seats
- Molded teeth
- Massive rubber-like bumper, handle & pistol grip
- Constant gallonage in all fog and straight stream patterns
- Flush without shutting down
- Compatible with Style 794 Quick Attack Foam Tube, see page 32
- Standard items include: black handle, black pistol grip, black bumper



Style 3020

Style	Length	Weight lbs. (kg)	Inlet Size	National Stock Number	Mil Spec Number	Flow at 100 PSI	
						GPM	LPM
3020	8 5/8" (219 mm)	7 3/4 (3.5 kg)	1 1/2" NPSH (38 mm)	4210-00-465-1906	MIL-N-24408E TY1-T1-1	95	360
3023	8 5/8" (219 mm)	7 3/4 (3.5 kg)	1 1/2" NPSH (38 mm)	4210-00-601-0986	MIL-N-24408E TY1-T1-2	125	475

### Brass 4AN Navy Nozzles With Fog Tips

Combination fog and straight stream nozzles to Navy specifications.

Style 2069  
Including Style 2073  
Fog Tip and Chain

Style	Length	Orifice	Weight lbs. (kg)	Inlet Size	Fog Tip	National Stock No.	Navships Number	Flow at 100 PSI	
								GPM	LPM
2069	8 3/4" (222 mm)	5/8" (16 mm)	9 (4.1 kg)	1 1/2" NPSH (38 mm)	2073	4210-00-392-2943	803-1385834	* 52	* 197
2074	10 1/4" (260 mm)	1" (25 mm)	14 3/4 (6.7 kg)	2 1/2" NH (65 mm)	2077	4210-00-392-2944	803-1385835	* 132	* 500

\* Fog flow only



### Brass Navy & Military Fog Tips

- 2073** 1 1/2" (38 mm) Fog Tip with Chain
- Fits Style 2069 Navy Nozzle
  - National stock no. 4210-00-372-0867
- 2077** 2 1/2" (65 mm) Fog Tip with Chain
- Fits Style 2074 Navy Nozzle
  - National stock no. 4210-00-372-0868



Style 2073



## Master Stream Foam Aeration Nozzles

- 3625 Master Stream Foam Nozzle**
- For use with AFFF
  - Expansion rate up to 12:1
- 3626 Master Stream Foam Nozzle with Dispersion Jaws**
- Specify Manual, Electric or Air Actuated Dispersion Jaws
  - Available without Dispersion Jaws
  - For use with AFFF
  - Expansion rate up to 12:1
- 3623 Dual Flow Automatic Master Stream Foam Nozzle**
- Electric Actuated infinitely adjustable Dispersion Jaws
  - For use with AFFF
  - Expansion rate up to 12:1
- 3624 3 1/2" Dual Flow Automatic Master Stream Foam Nozzle**
- Electric Actuated infinitely adjustable Dispersion Jaws
  - For use with FFFP
  - Expansion rate up to 6:1



Style 3625

 Style 3626  
With Manual Dispersion Jaws

Style	Inlet	Length	Weight lbs. (kg)	Flow	
				GPM	LPM
3625	2 1/2" (64 mm)	29 1/16" (738 mm)	6 1/4 (2.8 kg)	500* (250) at 100 psi	1900* (950) at 7 bar
3626	2 1/2" (64 mm)	28" (711 mm)	10 (4.5 kg)	800 or 1000 at 150 psi	3030 or 3800 at 10 bar
3623	2 1/2" or 3 1/2" (64 mm or 89 mm)	28" (711 mm)	14 1/4 (6.5 kg)	750/375 at 145 psi	2800/1420 at 10 bar
3624**	3 1/2" (89 mm)	54" (1372 mm)	29 (13 kg)	1600/800 @ @ (190 psi) (120 psi)	6000/3000 @ @ (13 bar) (8 bar)

\* Preset at 500 gpm, converts to 250 gpm

\*\* for use with 3356 only

## Foam Aeration Nozzles

- Combination Akrolite® and Pyrolite
- Units with pickup tube preset at 6% easily changed to 1/2%, 1% or 3%
- Expansion rate up to 14:1
- Pressure rated at 100 psi (7 bar)

- 3952 Foam Nozzle**
- Flows 95 GPM (360 lpm)
- 3951 Foam Nozzle with Pickup Tube**
- 3120 Foam Nozzle**
- For use with Style 2120 Eductor
  - Flows 120 GPM (450 lpm)



Style 3951

Style 3952

Style	Inlet	Length	Weight lbs. (kg)	Flow at 100 PSI	
				GPM	LPM
3120	2 1/2" (65 mm)	41" (1040 mm)	5 (2.3 kg)	120	450
3951	1 1/2" (38 mm)	38" (965 mm)	6 (2.7 kg)	95	360
3952	1 1/2" (38 mm)	38" (965 mm)	4 (1.8 kg)	95	360





### Mid-X™ Medium Expansion Foam Aeration Tube

The Mid-X Foam Tube is ideal for use in fire & vapor suppression applications with its wide range of expansion ratios. The Mid-X can produce a thick foam blanket with the nozzle pattern in a wide fog position or lower expansion foam providing better reach with the pattern in straight stream.

- Expansion rate up to 50:1
- Maximum Flow 250 gpm (950 lpm)
- Maximum Pressure 100 psi (7 bar)
- Weight: 4.5 lbs. (2.04 kg)
- Length: 13 1/2" (254 mm), Diameter: 10" (342.9 mm)



Style 866

Style	Nozzle	Year	Bumper Diameter
866	1 1/2" (38 mm) Turbojet	1993 - current	3 5/8" (92 mm)



## Quick-Attack™ Foam Aeration Tubes

Pyrolite® Foam Tubes are designed to easily and quickly clamp on to various Akron® nozzles. Use the chart to the right to determine the proper Quick-Attack Foam Tube.

- Provides air-aspirated foam capability
  - up to 12:1 expansion ratio with AFFF
- Flow: Style 790: 30 gpm (115 lpm), Style 770: up to 250 gpm (950 lpm) all others up to 125 gpm (475 lpm)
- Length: Style 790: 11 1/2", all others: 16 3/4"
- Typical weight 2 lbs 10 oz

Style	Nozzle	Year	Bumper Diameter
790	1" (25 mm) Turbojet	2000 - current	3" (76 mm)
	1" (25 mm) Assault Force & Defender	2000 - current All	
791	1 1/2" (38 mm) Turbojet	Pre - 1993	3 3/8" (86 mm)
	1 1/2" (38 mm) Industrial Turbojet	All	
792	1" (25 mm) Turbojet	1993 - 2000	3 5/8" (92 mm)
	1 1/2" (38 mm) Turbojet	1993 - current	
793	Mid-Range Turbojet	1993 - current	4 1/2" (114 mm)
	Mid-Range & 2 1/2" (64 mm) SaberJet	All	
770	High Range (65 mm) Turbojet	1993-Current	4 1/2" (114 mm)
794	1 1/2" (38 mm) Marauder with molded teeth	All	3 5/8" (92 mm)
	1 1/2" (38 mm) 3015-3021	All	
796	1 1/2" (38 mm) & Mid-Range Assault	All	3 7/8" (98 mm)
	Wide-Range Turbojet	All	
	1" (25 mm) & 1 1/2" (38 mm) SaberJet	All	
	Mid-Range Turbojet	Pre-1993	
797	Mid-Range Akromatic	All	4 1/4" (108 mm)
	2 1/2" (65 mm) Industrial Turbojet	All	



Style 792 Quick-Attack Foam Tube Shown with Turbojet Nozzle

## ProVenger Quick-Attack™ Foam Tubes

The Quick-Attack foam tubes are designed to efficiently snap-on and off the ProVenger® nozzles. Unique, quick-release tabs allow the tubes to be easily removed. These tubes produce aspirated foam up to a 12:1 expansion ratio with AFFF foam. Constructed of a lightweight, durable, high-strength polymer, the foam tubes are equipped to handle day-to-day firefighting conditions.

- Provides air-aspirated foam with expansion ratios up to 12:1 with AFFF
- Lightweight, snap-on assembly. No tools required.
- 5 year warranty

**624 Quick-Attack Foam Tube Compatible with Styles 1602 ProVenger Nozzles**

**638 Quick-Attack Foam Tube Compatible with Styles 1616, and 4116 ProVenger Nozzles**

Style	Swivel Inlet	Length	Width	Weight lbs. (kg)
624	1" (25.4 mm)	12 3/4" (324 mm)	3 3/8" (92 mm)	0.9 (0.4 kg)
638	1 1/2" (38 mm)	18 5/8" (473 mm)	4 1/2" (114 mm)	1.8 (0.8 kg)



Style 638





## FireFox™ Foam Aeration Tubes

The FireFox Aeration Tubes now give you the capability to convert your FireFox to a foam monitor for Class A or B foam applications, where a heavier foam blanket is desired. Each foam tube comes with a new turbine retaining ring that allows it to easily thread onto the end of the FireFox nozzle.

### 3620 Low Expansion FireFox Foam Tube

- Low expansion capability (up to 10:1) up to 125 gpm (475 lpm) on the 1 1/2" 30 - 125 gpm nozzle
- Length: 15 3/4" (400 mm)

### 3621 Low Expansion FireFox Foam Tube

- Low expansion capability (up to 10:1) up to 500 gpm (1900 lpm) on the 1 1/2" 125 - 350 gpm nozzle and 2 1/2" 225-500 gpm nozzle
- Also compatible with Mercury Nozzle Style 4445 & 4447
- Length: 14 1/8" (359 mm)

### 3622 Medium Expansion FireFox Foam Tube

- Medium expansion capability (up to 50:1) up to 125 gpm (475 lpm) on the 1 1/2" 30 - 125 gpm nozzle
- Length: 13 19/32" (345 mm)

Style 3621  
Shown on Style 3293



## Akromatic 1250 Foam Tube

The Style 737 Foam Tube is designed to simply and quickly clip on the Style 5177 Akromatic 1250 nozzle. This new foam tube will provide the capability to air-aspirate foam up to 6:1 expansion ratio with AFFF foam.

### 737 Akromatic 1250 Foam Tube

- Provides air-aspirated foam with expansion ratios up to 6:1 with AFFF
- Lightweight easy clip on assembly. No tools required
- Compatible with 5177 Akromatic Nozzle
- 5 year standard warranty

Style 737



Style	Material	Length	Weight lbs. (kg)	Flow at 100 PSI	
				GPM	LPM
737	Pyrolite®	18 7/8" (480 mm)	6.4 lbs. (2.9 Kg)	1250	4800

## Akromatic 2000 Foam Tube

The Style 738 Foam Tube is designed to simply and quickly clip on the Style 5178 or 5170 Akromatic 2000 nozzles. This new foam tube will provide the capability to air-aspirate foam up to 6:1 expansion ratio with AFFF foam.

### 738 Akromatic 2000 Foam Tube

- Provides air-aspirated foam with expansion ratios up to 6:1 with AFFF
- Lightweight easy clip on assembly. No tools required
- Compatible with 5178 & 5170 Akromatic Nozzle
- 5 year standard warranty

Style 738



Style	Material	Length	Weight lbs. (kg)	Flow at 100 PSI	
				GPM	LPM
738	Pyrolite®	21" (534 mm)	9.8 lbs. (4.4 Kg)	2000	7600

## SaberMaster™

The SaberMaster nozzles are the only multi-purpose master stream nozzles in the fire service today. The SaberMaster 1250 makes remote controlled monitors remote because you can now easily change from solid bore to fog flow streams with the flip of a switch. The SaberMaster 500 allows you to switch from solid bore to fog without shutting down. No other master stream nozzles have this 2-in-1 capability.

- SaberMaster 1250 reduces the risk of injury by not having to climb onto the deck to change tips
- Provides smooth bore reach and penetration OR fog stream cooling and protection, without having to shut down the water flow to switch tips.
- No issues with tip storage or missing tips because changing from a solid bore to adjustable fog pattern is built-in
- SaberMaster 1250 designed for use with Style 3440 DeckMaster or Style 3480 StreamMaster™ II Monitors
- SaberMaster 500 designed for use with Style 3443 Mercury™
- Built-in Stream Shaper (SaberMaster 1250)



Style 1578



Style 1545

Style	Material	Pattern Control	Fog Flow		Solid Bore Orifice	Inlet	Voltage	Length	Weight lbs. (kg)
			GPM	LPM					
1545	Pyrolite	Manual	350*	1325*	1 3/8" (35 mm)	2 1/2" (65 mm)	-	10 7/16" (265 mm)	8 1/2 (3.9 kg)
1578	Pyrolite®	Electric	1250*	4800*	2", 1 1/2" or 1 3/8" (51, 35 or 38 mm)	2 1/2" or 3 1/2" (65 or 89 mm)	12 or 24 Volt	15 5/32" (309 mm)	17 (7.7 kg)

\* Flow at 80 psi  
See page 176 Technical Data section for performance details

## Akromatic® 2000

Designed for flows from 500 to 2000 gpm (1900-7600 lpm) at an operating pressure of 80 psi (5.5 bar)



Style	Material	Pattern Control	Flow		Optional Flow		Inlet	Teeth	Voltage	Length	Weight lbs. (kg)
			GPM	LPM	GPM	LPM					
5071**	Brass	Manual	500-2000	1900-7600	-	-	3 1/2" (89 mm) (NH OR NPSH ONLY)	None	NA	12" (305 mm)	37 1/4 (16.9 kg)
5170	Pyrolite	Manual	500-2000	1900-7600	500-1500	1900-5700	3 1/2" (89 mm) (NH OR NPSH ONLY)	Fixed	NA	9 1/8" (232 mm)	15 1/4 (6.9 kg)
5178	Pyrolite	Electric	500-2000	1900-7600	500-1500	1900-5700	3 1/2" (89 mm) (NH OR NPSH ONLY)	None	12 or 24 Volt	9 1/2" (241 mm)	15 1/2 (7.0 kg)

\* FM approved Style 5071  
See page 176 Technical Data section for performance details



Style 5178

## Akromatic 1250

Designed for flows from 250 to 1250 gpm (950-4800 lpm) - At 80 psi (5.5 bar) operating pressure

- Style 5177 now with manual override
- Style 5160, 5161, and 5177 complete with built-in stream shaper

Style	Material	Pattern Control	Flow		Optional Flow		Inlet	Teeth	Voltage	Length	Weight lbs. (kg)
			GPM	LPM	GPM	LPM					
5075	Pyrolite	Electric	250-1250	950-4800	250-1000	950-3800	2 1/2" or 3 1/2" *** (65 or 89 mm)	**	12 or 24 Volt	9" (229 mm)	12 1/2 (5.7 kg)
5160	Pyrolite	Manual	250-1250	950-4800	250-1000	950-3800	2 1/2" or 3 1/2" *** (65 or 89 mm)	None	-	9 1/2" (241 mm)	12 (5.4 kg)
5161*	Brass	Manual	300-1250	1140-4800	-	-	2 1/2" or 3 1/2" (65 or 89 mm)	None	-	9 1/2" (241 mm)	26.8 (12.2 kg)
5177	Pyrolite	Electric	250-1250	950-4800	250-1000	950-3800	2 1/2" or 3 1/2" *** (65 or 89 mm)	None	12 or 24 Volt	10 3/8" (264 mm)	13 (5.9 kg)

\* FM approved Style 5161  
\*\* Flat dispersed pattern  
\*\*\* 3 1/2" (89 mm) in NH only  
See page 176 Technical Data section for performance details



Style 5075



Style 5160



Style 5161  
Shown with optional paint



Style 5177



### Turbomaster™

A family of adjustable gallonage master stream nozzles. Each nozzle comes equipped with four distinct, calibrated, and selectable flow settings.

- Pattern detents for positive stream positioning

Style	Material	Pattern Control	Flow at 100 PSI (7 bar)		Optional flow at 100 PSI (7 bar)		Inlet	Teeth	Length	Weight lbs. (kg)
			GPM	LPM	GPM	LPM				
1745	Pyrolite®	Manual	250-400-550-750	950-1525-2100-2900	130-250-400-500	500-1000-1500-2000	2 1/2" (65 mm)	Spinning	9" (241 mm)	11 (5.4 kg)
1755	Pyrolite	Manual	500-750-1000-1250	1900-2900-3800-4800	-	-	2 1/2" (65 mm)	Spinning	10" (229 mm)	13 (5.7 kg)
1757	Pyrolite	Manual	350-500-750-1000	1325-1900-2900-3800	-	-	2 1/2" (65 mm)	Spinning	10" (229 mm)	13 (5.9 kg)

See page 176 Technical Data section for performance details



Style 1745

### Aquastream™

A fixed gallonage master stream nozzle designed for heavy-duty use on fixed monitors.

- With grease fitting

Style	Material	Pattern Control	Flow at 100 PSI (7 bar)		Inlet	Teeth	Length	Weight lbs. (kg)
			GPM	LPM				
4450**	Brass	Manual	500 (300 & 700)*	1900 (1140 & 2650)*	2 1/2" (65 mm)	Fixed	7" (17.8 cm)	14 1/2 (6.6 kg)
4452	Pyrolite	Manual	500 (300 & 700)*	1900 (1140 & 2650)*	2 1/2" (65 mm)	Fixed	7" (17.8 cm)	4 3/4 (2.2 kg)

\* Field changeable spacers included with nozzle

\*\* FM Approved Style 4450

See page 177 Technical Data section for performance details



APPROVED\*\*  
Style 4450 Only



Style 4452

### Rampage™

A fixed gallonage master stream nozzle with built-in stream shaper designed for flows up to 1250 gpm (4800 lpm). Ideal for heavy-duty use on fixed monitors. Style 4460 has a twist shutoff.

Style	Material	Pattern Control	Flow at 100 PSI (7 bar)		Inlet	Teeth	Length	Weight lbs. (kg)
			GPM	LPM				
4460	Brass	Manual	750 (500, 1000 & 1250)*	2800 (1900, 3800 & 4800)*	2 1/2" (65 mm)	None	9" (229 mm)	23 1/4 (10.5 kg)
4461**	Brass	Manual	750 (500, 1000 & 1250)*	2800 (1900, 3800 & 4800)*	2 1/2" (65 mm)	None	9" (229 mm)	23 1/4 (10.5 kg)

\* Factory set at 750 gpm (2800) - field changeable to 500, 1000 or 1250 gpm (1900, 3800 or 4800 lpm), spacers included with nozzle.

\*\* FM Approved Style 4461

See page 177 Technical Data section for performance details



APPROVED\*\*  
Style 4461 Only



Style 4460

### Rampage™ Nozzle With Electric Pattern Actuation

- All brass and stainless steel construction
- Ideal for mining applications
- 2 1/2" NH inlet
- Exposed surfaces protected by heavy-duty, weather resistant bellows - SD model only, Must Specify
- Maximum Pressure: 200 psi/14 bar
- Maximum Motor Current Draw:
  - 12 Volt Motor: 3 amps
  - 24 Volt Motor: 1.5 amps

Style	Material	Flow at 100 PSI (7 bar)		Inlet	Length	Weight lbs. (kg)
		GPM	LPM			
4462	All brass and stainless steel construction	500-1000 750 (500&1000)*	1900-3800 2800 (1900 & 3800)	2.5" NH (65 mm)	8 1/8" (206 mm)	19.6 (8.9 kg)

\* Factory set at 750 gpm - field changeable to 500 or 1000 gpm



Style 4462  
with Electric  
Pattern Actuation  
Severe Duty (SD)  
Model Shown







### Akrofoam™

The Akrofoam nozzles are self-educing master stream nozzles designed for educing foam at flow rates up to 2000 gpm (7600 lpm).

#### 4475 1000 gpm (3800 lpm) Pyrolite Akrofoam

- Spring loaded baffle that allow flow setting selection of 350, 500, 750, or 1000 gpm (1325, 1900, 2900, or 3800 lpm) with a simple push and turn of the baffle head.
- Quick connect, adjustable metering head with pick up rates 1% & 3%, plus 6% for 350 & 500 gpm (1325 & 1900 lpm) and 1% & 3% for 750 & 1000 gpm (2900 & 3800 lpm)



Style 4475

#### 4480 1000 gpm (3800 lpm) Akrofoam Pyrolite Nozzle with Electric Pattern Actuation

- Electric pattern actuation
- Spring loaded baffle provides field adjustable flows up to 1000 gpm (4800 lpm)
- Quick connect, adjustable metering head with pickup hose
- Compatible with the Style 3030 Jet Ratio Controller
- Pick up rates:
  - 350-500 gpm (1325-1900 lpm): 1%, 3% or 6%
  - 750-1000 gpm (2900-3800): 1% or 3%



Style 4480

#### 4470 1000 gpm (3800 lpm) Brass Akrofoam

- Factory set at 500 gpm (1900 lpm) 3% and field changeable to 350, 750, or 1000 gpm (1325, 2900, or 3800 lpm)
- Grease fitting for easy maintenance
- Optional Foam Shutoff Valve, Drum Seal Kit & Quick Connect
- Metering capability of 1%, 3%, & 6% for 350 & 500 gpm (1325 & 1900 lpm), and 1% & 3% for 750 & 1000 gpm (2900 & 3800 lpm).

Style 4470



#### 4471 1000 gpm (3800 lpm) Brass Akrofoam Nozzle with Electric Pattern Actuation

- All brass and stainless steel construction
- Ideal for mining applications
- Exposed surfaces protected by heavy-duty, weather resistant bellows
  - Metering Rate :
    - 1%, 3%, & 6% for 350 & 500 gpm (1325 & 1900 lpm)
    - 1% & 3% for 750 & 1000 gpm (2900 & 3800 lpm)
  - Maximum Pressure: 200 psi/14 bar
  - Maximum Motor Current Draw:
    - 12 Volt Motor: 3 amps
    - 24 Volt Motor: 1.5 amps

Style 4471 with Electric Pattern Actuation



#### 4478 2000 gpm (7600 lpm) Akrofoam Pyrolite Nozzle

- Fog pattern: straight stream to wide fog
- Manual pattern control
- Pick up rates: 750, 1000, 1500, 2000 gpm (2900, 3800, 5700, 7600 lpm) at 1% and 3%; 750, 1000 gpm (2900, 3800 lpm) at 6%



Style 4478

#### 4479 2000 gpm Pyrolite Nozzle with Electric Pattern Actuation

- Spring loaded baffle that allows flow setting selection of 750, 1000, 1500, or 2000 gpm (2900, 3800, 5700, or 7600 lpm) with a simple push and turn of the baffle head
- Quick connect, adjustable metering head with pick up rates 1%, 3% and 6% for 750 and 1000 gpm (2900 and 3800 lpm) and 1% & 3% for 1500 and 2000 gpm (5700 and 7600 lpm)
- Orifices store conveniently on the nozzle for easy change of pickup rate and storage when not in use
- Electric pattern actuation



Style 4479



Akrofoam works well with Jet Ratio Controller Style 3030 See Page 96

Style	Material	Pattern Control	Flow at 100 PSI (7 bar)		Inlet	Length	Weight lbs. (kg)
			GPM	LPM			
4475**	Pyrolite	Manual	500 (350, 750 & 1000)	1900 (1300, 2800 & 3800)	2 1/2" NH (65 mm)	9 1/4" (235 mm)	12 (5.4 kg)
4480	Pyrolite	Electric	350-500-750-1000	1300-1900-2800-3800	2.5 NH or 3.5 NH	10.6" (269 mm)	14 (6.4 kg)
4470***	Brass	Manual	500 (350, 750 & 1000)*	1900 (1300, 2800 & 3800)*	2 1/2" NH (65 mm)	12 3/8" (314 mm)	25 (11.3 kg)
4471****	Brass and Stainless Steel Construction	Electric	350, 500, 750 & 1000 @ 100 psi	1300, 1900, 2800 & 3800 lpm @ 7 bar	2.5" NH (65 mm)	12 1/4" (311 mm)	30 (13.6 kg)
4478	Pyrolite	Manual	750, 1000, 1500, 2000	2900, 3800, 5700, 7600	3-1/2" NH	13-3/4" (349 mm)	17.4 (7.8)
4479	Pyrolite	Electric	750, 1000, 1500, 2000	2900, 3800, 5700, 7600	3-1/2" NH	13-3/4" (349 mm)	19.4 (8.8)

\* Factory set to 500 gpm (1900 lpm) - field changeable to 350, 750 or 1000 gpm (1300, 2800 or 3800 lpm) with spacers included with nozzle

\*\* 44750006 pick up tube with metering head

\*\*\* 44700002 pick up tube only

See page 177 Technical Data section for performance details



## FireFox™ Nozzle

An electrically controlled nozzle with flows from 30 to 500 gpm (115 to 1900 lpm) at an operating pressure of 100 psi (7 bar). The FireFox nozzle comes with either a single fixed flow baffle or an adjustable four setting baffle and is for use with 12 or 24 Volt monitors featuring current limiting, such as the Style 3463 FireFox.

### 3293 FireFox Electric Nozzle

- 1 1/2" (38 mm) swivel inlet for flows up to 350 gpm (1325 lpm)
- 2 1/2" (65 mm) swivel inlet for flows 350 to 500 gpm (1325 to 1900 lpm)
- Spinning teeth
- Optional flat disperse pattern - Must specify
- Optional add-on foam tubes - See page 33
- Adjustable Flow Options:
  - 30-60-95-125 gpm (115-230-360-475 lpm) with electric flush
  - 125-175- 250-350 gpm (475-660-950-1325 lpm) without electric flush
  - 350-400-450-500 gpm (1325-1525-1700-1800 lpm) optional 500, 1000, 1500, 2000 LPM) without electric flush
- Fixed Flow Options: (Must specify flow rate)
  - 30 to 200 gpm (115 to 750 lpm) with electric flush
  - 225 to 500 gpm (850 to 1900 lpm) without electric flush



Style 3293

Size	Flow GPM (LPM)	Length	Weight lbs. (kg)
1 1/2" (38 mm)	30-125 (115-475)	7" (17.8 mm)	5 (2.3 kg)
1 1/2" (38 mm)	125-350 (115-1325)	7 3/4" (187 mm)	7.2 (3.4 kg)
2 1/2" (65 mm)	350-500 (1325-1900)	7 3/4" (187 mm)	7.5 (3.4 kg)

See page 176 Technical Data section for performance details

## Single Gallonage Master Stream

Style	Material	Pattern Control	Flow		Inlet	Teeth	Length	Weight lbs. (kg)
			GPM	LPM				
2171	Brass	Manual	500-2000*	3800-7600*	3 1/2" (89 mm)	None	12" (305 mm)	36 (16.3 kg)

\* Specify flow in 100 gpm (380 lpm) increments. Specify pressure from 70-100 psi (4.9-7 bar) in 10 psi (35 bar) increments



Style 2171

## Akromatic® 1000

This hydraulically actuated nozzle is designed for flows from 350-1000 gpm (1325-3800 lpm) At 100 psi (7 bar) operating pressure.

Style	Material	Pattern Control	Flow		Inlet	Teeth	Length	Weight lbs. (kg)
			GPM	LPM				
5055	Pyrolite	Hydraulic	350-1000	1325-3800	2 1/2" (65 mm)	Spinning	9 3/4" (248 mm)	9 1/4" (4.2 kg)
5056	Brass	Hydraulic	350-1000	1325-3800	2 1/2" (65 mm)	Spinning	9 3/4" (248 mm)	30 1/2" (13.8 kg)

See page 176 Technical Data section for performance details



Style 5055







### Akrochem™ 1250 or 2000 GPM Nozzles

Akrochem nozzles give you the flexibility of both dry chemical agent and foam solution or water applications. This versatile nozzle combines the effective reach of an automatic with the capability to deliver dry chemical agent at rates up to 20 lbs. (9 kg) per second. It is also designed for flowing water or foam solutions up to 2000 gpm (7600 lpm) at an operating pressure of 100 psi (7 bar).



Style 4040

Style	Material	Pattern Control	Flow		Inlet	Voltage	Length	Weight lbs. (kg)
			GPM	LPM				
4039	Pyrolite	Manual	250-1250	950-4800	2-1/2" or 3-1/2" (65 or 89 mm)	-	11-1/2" (292 mm)	11 (5)
4040	Pyrolite	Electric	250-1250	950-4800	2-1/2" or 3-1/2" (65 or 89 mm)	12 or 24 Volt	11-1/2" (292 mm)	11.5 (5.2)
4041	Pyrolite	Manual	750-2000	2900-7600	3-1/2" (89 mm)	-	13-3/4" (349 mm)	17 (7.7)
4042	Pyrolite	Electric	750-2000	2900-7600	3-1/2" (89 mm)	12 or 24 Volt	13-3/4" (349 mm)	17-1/2 (7.9)

See page 177 Technical Data section for performance details

### Mercury™ Nozzles

The Mercury nozzles have excellent straight stream performance and a wide, dense, fully adjustable fog pattern. Choose between the single flow orifice Style 4445 and the adjustable flow baffle Style 4447.

Style	Material	Pattern Control	Flow at 100 PSI (7 bar)		Inlet	Teeth	Length	Weight lbs. (kg)
			GPM	LPM				
4445	Pyrolite®	Manual	500	1900	2 1/2" (65 mm)	Spinning	7" (178 mm)	5 (2.3 kg)
4447	Pyrolite	Manual	250-375-500	950-1400-1900	2 1/2" (65 mm)	Spinning	7" (178 mm)	5 (2.3 kg)
5148*	Pyrolite	Manual	500	1900	2 1/2" (65 mm)	-	12 1/4" (318 mm)	11 (5 kg)

\* Oscillating Mercury Quick Attack Nozzle for use on the Mercury Quick Attck Monitor only

Style	Material	Pattern Control	Flow at 75 PSI (5 bar)		Inlet	Teeth	Length	Weight lbs. (kg)
			GPM	LPM				
5147	Pyrolite	Manual	300, 500, 800, 1000	1140-1900-3030-3800	2 1/2" (65 mm)	-	7 5/16" (185 mm)	3.8 (1.7 kg)
5150	Pyrolite	Manual	250-1000	950-3800	2 1/2" (65 mm)	-	9 13/32" (239 mm)	9.61 (4.4 kg)
5148*	Pyrolite	Manual	800, 1000	3030, 3800	2 1/2" (65 mm)	-	11 3/4" (299 mm)	13.1 (5.9 kg)

\* Oscillating MercuryMaster Nozzle for use on the MercuryMaster Monitor only  
See page 173 Technical Data section for performance details



Style 4447



Style 5150  
Automatic Nozzle



Style 5147  
Adjustable Flow  
Nozzle



Style 5148



## Forestry Multi-Purpose Monitor 300 GPM (1140 LPM)

The 3462 provides an extremely rugged durable design ideal for a multitude of applications with flows up to 300 gpm (1140 lpm). This compact monitor features a fully sealed integrated electrical control system with waterproof locking connectors for all motors, power and control connections to withstand harsh environments. The high speed motors provide proportional speed control for pinpoint stream positioning and accuracy. With a wide range of available nozzles, the 3462 is ideal for use in water, foam and CAFS applications.

### Standard Features:

- CAN proportional speed joystick control
- Lightweight Pyrolite® construction, 23 lbs. (10.4 kg) without nozzle
- Integrated and sealed electronics
- Waterproof (IP 67 rated) locking connectors
- Simple “plug and play” installation
- 320° maximum rotation range with stops at +/- 90°
- 135° maximum elevation range with stops at +45° and -20°
- 12V or 24V (Must Specify)

### Nozzle Options:

- Style 3293 low flow adjustable electric fog nozzle with flush 30-60-95-125 gpm (115-230-360-475 lpm)
- Style 3293 mid flow adjustable electric fog nozzle 125-175-250-300 gpm (475-660-950-1140 lpm)
- Style 3293 fixed orifice fog nozzles (must specify flow and pressure)
- Quick Attack™ foam tube attachments for Style 3293 fog nozzles
- Smooth bore tips

### Additional Options:

- 2" quick disconnect
- Wireless remote control (CAN interface)
- 2" electric valve
- Flat disperse fog pattern available on all Style 3293 nozzles



Style 3462  
Shown with 3293  
125-300 gpm Nozzle



Style 6035  
CAN Joystick



Wireless Remote  
Control Available



Style 6037  
CAN Wireless  
Interface



“Plug and play” connectors



2" Quick-Disconnect,  
Ideal for Tilt Cab Trucks

Style	Weight lbs. (kg)	Height	Width	Depth	Inlet	Outlet	Flow	
							GPM	LPM
3462	23** (10.4 kg)	13 3/16"* (335 mm)	11 9/16" (294 mm)	8 29/32" (226 mm)	2" NPT (50 mm)	1 1/2" (38 mm)	300	1140

\* Base to center of outlet  
\*\* Not including nozzle



## FireFox™ Multi-Purpose Monitor 500 GPM (1900 LPM)

The FireFox Electric Monitor from Akron® is a technologically advanced remote controlled monitor with flows up to 500 gpm (1900 lpm). The FireFox Monitor is designed to meet various water, foam, CAFS, and dry chemical needs. This versatile monitor can be used for wildland firefighting, mini pumpers, crash truck turrets, deicing, fixed site facilities, arena protection and many other unique applications.

### 3463 FireFox Electric Monitor

- 320° horizontal travel with adjustable stops at +/- 90°
- 135° vertical travel (+90° to -45°) with adjustable stops at +45° and -20°

#### Monitor Options: (Must specify)

- Automatic Oscillation & Stow
- Remote 2" or 2 1/2" Electric Valve
- 12 or 24 volt (Must specify)
- 2" Quick disconnect
- Position feedback - Optional

#### Nozzle Options:

- See page 170 for Monitor/Fog Nozzle Compatibility Chart
- Adjustable or Single Fixed Flow Baffle up to 500 gpm (1900 lpm)
- Dry Chemical Nozzle - Optional
- Foam Tubes - Optional (See page 33)
- Smooth bore tip with mini shaper

**NOTE:** All FireFox Fog Nozzles are available with optional flat dispersed pattern



Adjustable Flows Available  
See page 38 for nozzle specs

#### 3293 Nozzle Options

Flow Category	GPM	30	60	95	125
		LPM	115	230	360
Medium Flow	GPM	125	175	250	350
	LPM	475	660	950	1325
High Flow	GPM	350	400	450	500
	LPM	1325	1525	1700	1900



2" Quick-Disconnect, Ideal for Tilt Cab Trucks

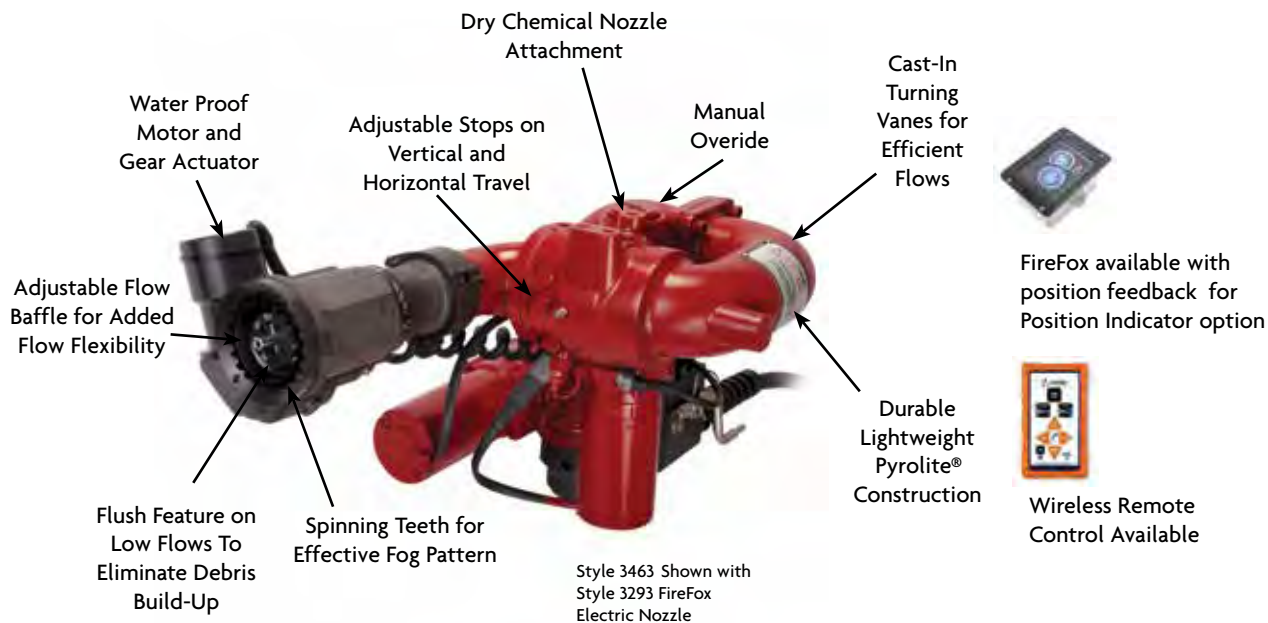

Style	Weight lbs. (kg)	Stow Position			Inlet	Outlet	Flow	
		Height	Width	Depth			GPM	LPM
3463	25 (11.3 kg)*	11 3/4" (298 mm)	11" (279 mm)	11 1/2" (292 mm)	2" or 2 1/2" NPT (50 or 65 mm) 1 1/2" or 3" FL (38 or 75 mm)	1 1/2" or 2 1/2" NH (38 or 65 mm)	500	1900

\* Less nozzle



## Gemini™ Monitor 1000 GPM (3800 LPM)

The Gemini Monitor is of Pyrolite® construction with a compact split waterway designed with cast-in turning vanes. Providing high performance and exceptional durability.

### 3479 Electric Gemini Monitor

- 135° vertical travel and 348° horizontal travel, both with adjustable stops
- Manual override
- 12 or 24 volt (24 volt version CE approved - Must specify)
- Wireless remote control available
- See page 170 for Monitor/Fog Nozzle Compatibility Chart

Style	Weight lbs. (kg)	Height	Width	Depth	Inlet	Outlet	Flow	
							GPM	LPM
3479	46* (20.8 kg)	20" (508 mm)	13 3/4" (336 mm)	10 3/16" (259 mm)	3" - 4" (75-100 mm) NPT or FL	2 1/2" (65 mm)	1000	3800

\* Less nozzle



Style 3479  
Shown with Style 5177  
Akromatic Nozzle

Wireless Remote Control Available



## DeckMaster™ Monitor 1250 GPM (4800 LPM)

The DeckMaster Monitor is a technologically advanced, electrically controlled deck monitor with automated elevating capability. The unique design of the DeckMaster Monitor allows electric elevation and positioning 24" above the base of the flange for operation over obstructions with the push of a switch.

### 3440 DeckMaster Electric Monitor

- 340° horizontal rotation with adjustable stops
- Vertical travel 90° above to 45° below horizontal
- Manual override for horizontal, vertical and elevation control
- Stow position set easily by the end user
- Automatic drain for freeze protection
- Diagnostic light for trouble-shooting
- Connection for deployed indicator light
- Available in 12 or 24 volt (Must specify)
- Optional position feedback (Must specify)
- See page 170 for Monitor/Fog Nozzle Compatibility Chart



Style 3440  
Shown deployed  
with Style 1578  
SaberMaster™  
Nozzle

Style 3440 Shown in a  
typical stowed position

See page 51, 172 for Electric Monitor Accessories

Style	Weight lbs. (kg)	In Stowed Position			Inlet	Outlet	Flow	
		Height	Width	Depth			GPM	LPM
3440	55 (25 kg)*	14 1/2" (368 mm)	16 3/4" (425 mm)	17" (431 mm)	3" FL (75 mm)	2 1/2" NH (65 mm)	1250	4800

\* Less Nozzle



Wireless Remote Control Available



**Combine with the Style 1578 SaberMaster nozzle to meet NFPA 1901 recommendations to use remote control monitors for safe deck gun operations.**

Remote DeckMaster operation eliminates the need to have a firefighter on the deck to operate the monitor.



DeckMaster available with position feedback and position indicator option

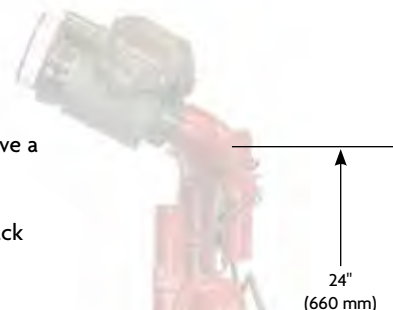

## Electric Riser

Overcome increased heights of apparatus bodies, raised roof cabs, and other obstacles with the electric riser. It enables an added 12 inches (305 mm) of extension and is the perfect complement to the already superior versatility of the DeckMaster, StreamMaster and other compatible monitors.

### 3406 Electric Riser For DeckMaster & StreamMaster

- 3" waterway
- 12" extension
- With unique three-piece design, the extremely compact device is only 18 1/2" (470 mm) when nested
- Can be utilized within pump modules that have limited space
- Electrically actuated (12 or 24 volt - Must specify)
- Durable lightweight Pyrolite® construction
- Manual override
- 5 year warranty
- Inlet option: 3" (75 mm) victaulic or NPT (Must specify)
- Outlet options 3" (75 mm) or 4" (100 mm) flange (Must specify)

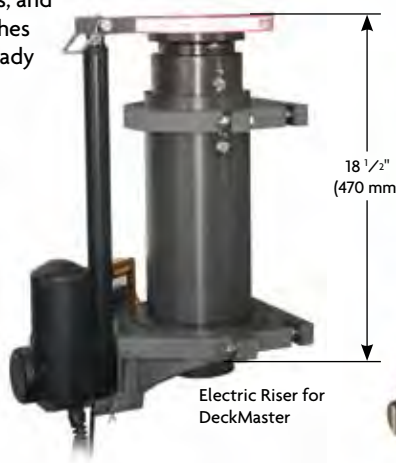

Electric Riser for DeckMaster

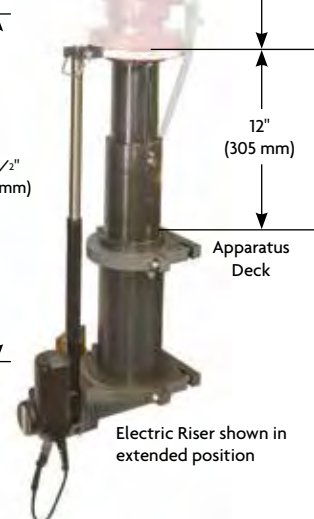

Electric Riser shown in extended position

Style	Weight lbs. (kg)	Height	Width	Depth	Inlet	Outlet	Flow	
							GPM	LPM
3406	38 (17.3 kg)	18 1/2 (470 mm)	11 11/16" (297 mm)	12" (305 mm)	3" (75 mm) NPT or VIC	3" or 4" FL (75 mm or 100 mm)	1250* 1500**	4800* 5700**

\* For 3482 \*\*For 3480

## StreamMaster™ II Monitor

With its patented design, the StreamMaster II provides efficient flows up to 2000 gpm (7600 lpm) in a compact configuration. The unique waterway design provides balanced forces on the outlet and reduced friction resulting in exceptional stream performance. The standard absolute position sensors provide advanced features like programmable obstacle avoidance, oscillation, and stow/deploy positions. The onboard, fully sealed IP 67 CAN control system features “plug and play” installation with built-in wireless capability and a USB port for quick software updates in the field. The 355 degree rotation and 165 degree elevation range can be configured for deck or aerial applications making this high performance compact monitor truly universal.



Style 3482  
Shown with 5177 Nozzle

US Patent 8,678,022

### 3482 StreamMaster II Monitor 1250 gpm (4800 lpm)

- Compact industry leading operating envelope (6", 152 mm)
- Lightweight Pyrolite construction
- Simple “plug and play” installation
- Integrated wireless compatibility, utilizing the optional 3600 hand-held remote control
- Optional manual override hand-wheels
- Absolute position sensors
- Waterproof (IP 67 rated) control system with locking connectors
- User programmable obstacle avoidance
- User programmable stow and deploy positions
- Superior range of motion
  - Rotation Range 355°
  - Elevation Range +120°, - 45°
- 12V or 24V operation
- Compatible with 3406 Electric Riser
- Ladder avoidance mode - Optional

Style	Weight lbs. (kg)	Height	Width	Depth	Inlet	Outlet	Flow	
							GPM	LPM
3482	38.2 (17.3 kg)*	16" (400 mm)	11" (280 mm)	16 1/8" (410 mm)	3" Flange (DN80)	2 1/2" Male (65 mm)	1250	4800

\* Less nozzle

See page 51, 172 for Electric Monitor Accessories

### Nozzle Options:



Style 2499

Style 2498

Style 3485 Mini Shaper

Style 1578 SaberMaster Nozzle

Style 5177 Akromatic 1250 Nozzle

Style 5176 Excel™ 1000

Style 4040 Akrochem Nozzle

Style 4480

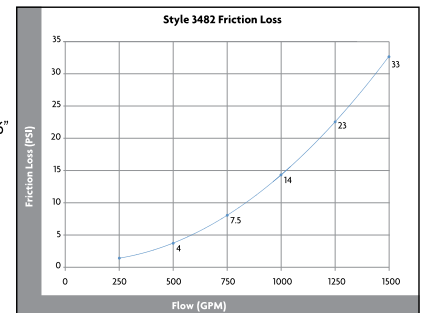
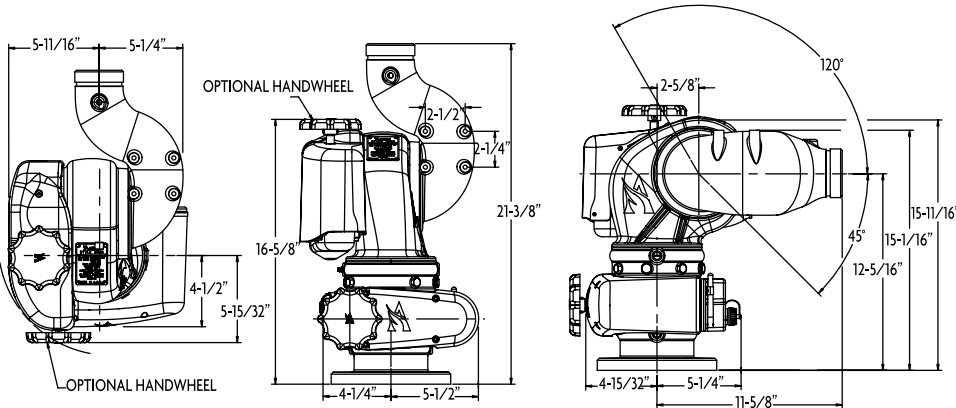





### StreamMaster™ II Monitor

#### 3480 StreamMaster II Monitor 2000 gpm (7600 lpm)

- Compact industry leading operating envelope (6", 152 mm)
- Lightweight Pyrolite construction
- Simple "plug and play" installation
- Integrated wireless compatibility, Utilizing the optional 3600 hand-held remote control
- Optional manual override hand-wheels
- Absolute position sensors
- Waterproof (IP 67 rated) control system with locking connectors
- User Programmable Obstacle Avoidance
- User Programmable stow and deploy positions
- Superior Range of Motion
  - Rotation Range 355°
  - Elevation Range +120°, - 45°
- 12V or 24V operation
- Compatible with 3406 Electric Riser
- Ladder avoidance mode - Optional



Style 3480  
Shown with 5177 Nozzle

US Patent 8,678,022

Style	Weight lbs. (kg)	Height	Width	Depth	Inlet	Outlet	Flow	
							GPM	LPM
3480	40.7 (18.5 kg)*	16" (400 mm)	11 1/8" (295 mm)	17" (430 mm)	4" Flange (DN100)	3 1/2" Male (89 mm)	2000	7600

\* Less nozzle

See page 51, 172 for Electric Monitor Accessories

#### Nozzle Options:



Style 3499

Style 2499

Style 2498

Style 3485 Mini Shaper

Style 1578 SaberMaster Nozzle

Style 5178 Akromatic 2000 Nozzle

Style 5177 Akromatic 1250 Nozzle

Style 5176 Excel™ 1000

Style 4040, 4042 Akrochem Nozzle

Style 4480

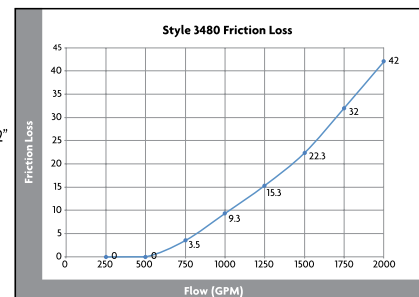
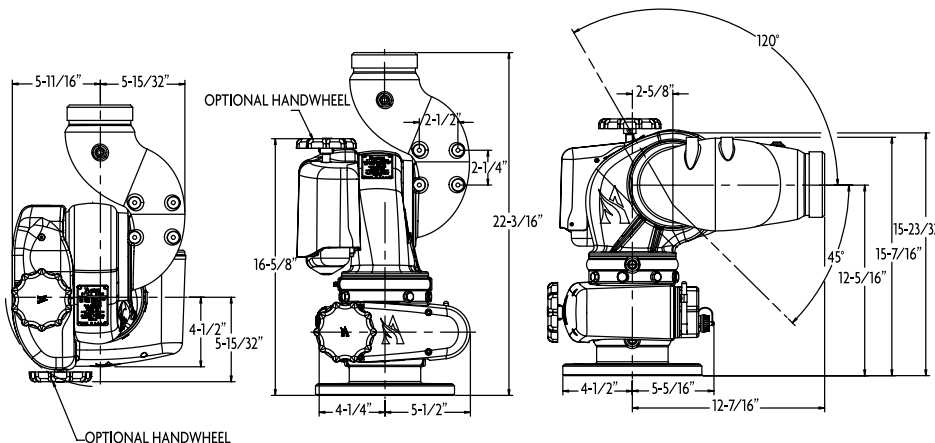

## Trident™ HFRT-10 High Flow Monitor 2650 GPM (10,000 LPM)

The Trident HFRT-10 High Flow Firefighting Monitor is the pinnacle water delivery system for fire fighting in the world. This monitor is a culmination of years of industry leading experience and unmatched engineering that has resulted in superior performance and reliability. The Trident's revolutionary look and high tech functionality will deliver up to 2650 gpm (10,000 lpm) of water and/or foam solutions in excess of 395' (120 m), rotates 355° horizontally, and exceeds all your expectations.

### 3356 Trident HFRT-10

- Manual handwheel override
- Flow: 350-2650 gpm (1325-10,000 lpm)
- Horizontal rotation up to 355°
- Vertical travel from +70° & -30°
- Outlet: 3.5" NH (89 mm)
- Position feedback
- 12V & 24V
- Compatible with Electric MasterStream Nozzles

#### Inlet Options:

- Bottom 4" Flange 150 lb (DN 100)
- Rear 4" Flange 150 lb (DN 100)
- Rear 4" and 5" Victaulic Flange (100 mm and 125 mm)

#### Options:

- Style 2489 solid bore tip with 395' (120 m) reach capability
- Style 3624 1700 gpm at 230 psi Foam Tube with Reach up to 305' (93 m)
- Style 5178 Akromatic 2000 gpm Fog nozzle with 300 feet (91 m) reach capability
- Variable Speed Joystick
- Wireless Remote Control
- Dry Chemical Piggy Back
- Inside Cab Manual Overrides with 6' Cable
- Integrated Dual Flow Fog Nozzles and Foam Tubes



Style 3356  
Trident Standard Outlet Shown  
with Style 2489 Smooth Bore  
and 3485 Stream Shaper



Style 3356  
Trident Standard Outlet  
Shown with Style 5178  
Akromatic™ 2000 Nozzle

3356 High Flow Monitor  
Friction Loss: (Monitor only)

Flow	PSI (bar)
750 GPM (3000 LPM)	4 (.28)
1000 GPM (3800 LPM)	6 (.41)
1500 GPM (6000 LPM)	17 (1.2)
2000 GPM (7600 LPM)	29 (2)
2650 GPM (10,000 LPM)	51 (3.5)

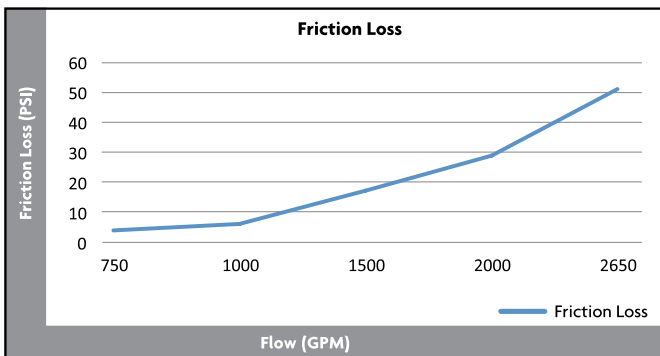



### AeroMaster12® Monitor 3000 GPM (12000 LPM)

The AeroMaster12 incorporates a waterway that is both velocity and pressure balanced. With this innovation, this monitor provides a smooth operation through its 355° of rotational range and 190° (+120°/-70°) of vertical travel. Additionally, a friction loss of less than 1.4 bar (25 psi) at 12,000 lpm (3,000 gpm) is achieved. The standard absolute position sensors provide advanced features like programmable obstacle avoidance, oscillation, and stow/deploy positions. The onboard, fully sealed IP 67 CAN based monitor control system features simple “plug and play” installation with built-in wireless capability and a USB port for quick software updates in the field.



#### 3000 AeroMaster12 Monitor

- Compact low profile design
- Lightweight Pyrolite construction
- Pressure and velocity balanced for faster speeds and longer life cycle
- CAN multiplexed controls provide simple “plug and play” installation
- Integrated wireless compatibility, utilizing the optional 3600 hand held remote control
- Waterproof (IP 67 rated) electronic control system with locking connectors
- User programmable obstacle avoidance, stow and deploy positions, soft stops, and auto oscillation
- Superior range of motion
  - Rotation range 355°
  - Elevation range 190° (+120° to -70°)
- Proportional speed control
- Manual override handwheel controls (only spin when engaged in manual operation)
- Optional 12V or 24V operation
- Optional Point-Aim Joystick
- Optional patent pending Style 730 Quick-Attack field detachable foam tube
- Optional patent pending flat dispersed ring on fog nozzle



Style 3000  
Shown with Style 3700 Nozzle  
with Optional Flat Disperse Ring

US Patent 8,678,022

Style	Weight lbs. (kg)	Height	Width	Depth	Inlet	Outlet	Flow		Pressure	
							GPM	LPM	Working (Pr)	Maximum (Pn)
3000	112 (51)	19 5/16" (491 mm)	23 3/32" (587 mm)	27 23/32" (700 mm)	6" (150 mm) or ASA & DIN 150	4 1/2" (115 mm)	3000	12000	150 psi (10 bar)	232 psi (16 bar)

\* Less nozzle

### Akromatic 3000 Nozzle with Optional Foam Tube

The Style 3700 is a 6,000 to 12,000 lpm (1,500 - 3,170 gpm) automatic nozzle with reach capabilities up to 125 m (410'). With a 4.5" inlet, this nozzle is designed as the perfect match to the Aeromaster12 monitor. The Style 3700 is available with an optional flat disperse pattern ring providing outstanding ground coverage of 46 m (152') wide and maintains in cab operator visibility when used in roof mounted applications. To maximize foam expansion and drain time, just add the field detachable Style 730 Quick-Attack foam tube. The combination of the flat dispersed pattern and the detachable foam tube is patent pending. This flat dispersed pattern ring allows the dispersion jaws to be moved from the end of the foam tube to the front of the foam tube. The result is a lighter foam tube with less moving parts.

#### 3700 Akromatic 3000 Nozzle with Optional Foam Tube

- Lightweight Pyrolite construction
- Automatic flow ranges from 6000 - 12,000 lpm (1,500 - 3,000 gpm)
- Nozzle callibrated at 10 bar at the monitor inlet
- Optional flat dispersed ring on the fog nozzle
- Optional Style 730 Quick-Attack Detachable Foam Tube
- Optional 12V or 24V operation



**Style 3000**  
Shown with Style 3700 Nozzle  
and Style 730 Foam Tube



**Style 3700**  
Shown with Optional  
Flat Disperse Ring



**Style 3700**  
Nozzle Only



**Style 730 with 3700**  
Shown with Optional  
Foam Tube



## Renegade™ Electric Monitor 5000 GPM (19,000 LPM)

The Renegade electric monitor is a large flow master stream appliance designed specifically for industrial pumpers, aerials, or fixed site applications. This unique monitor combines an all-electric control package with a compact design to provide superior performance and easy installation.

### 3580 Renegade Electric Monitor

- Lightweight Pyrolite® construction less than 200 lbs. including the nozzle
- Low friction loss only 27 psi at 5000 gpm
- Nozzles incorporate new stream shaper for improved stream performance
- Advanced features: position feedback, automatic stow, low current draw and more
- Additional features: manual overrides, drain port, multiple outlet positions and more
- Optional position indicator (Must specify)
- See page 170 for Monitor/Fog Nozzle Compatibility Chart

Three middle elbow mounting positions (Must specify)

- ① 90° - Aerial Applications
- ② 45° - Pumper Applications
- ③ 22 1/2° - Pumper Applications (With Height Restriction)



Style 3580  
Shown with Style 5088  
Akromatic® Nozzle

Style	Weight lbs. (kg)	Inlet	Outlet	Flow	
				GPM	LPM
3580	150 (68 kg)*	8" FL (200 mm)	6" FL & Storz (150 mm)	5000	19000

\* Less nozzle

Renegade Cube Dimensions			
Middle Elbow Angle	22.5°	45°	90°
Dimensions (LxWxH)*	33 3/16"x28"x22" (843x711x559 mm)	29 5/16"x28"x28" (245x711x711 mm)	16 11/16"x28"x33" (424x711x838 mm)
Dimensions (LxWxH) w/ nozzle*	49 11/16"x28"x22" (1262x711x559 mm)	42 13/16"x28"x28" (1088x711x711 mm)	30"x28"x33" (767x711x838 mm)

\* 6" flange outlet

Available Nozzles	Type	Flow		PSI (bar)
		GPM	LPM	
5088	Automatic	1000-5000	3800-19000	80 (5.5 bar)
2188	Fixed	1000-5000	3800-19000	80 (5.5 bar)
2189*	Adjustable	1000, 2000, 3000, 5000	3800, 7600, 19000	80 (5.5 bar)
		3000, 4000, 5000	11400, 15200, 19000	

\* Must specify flow

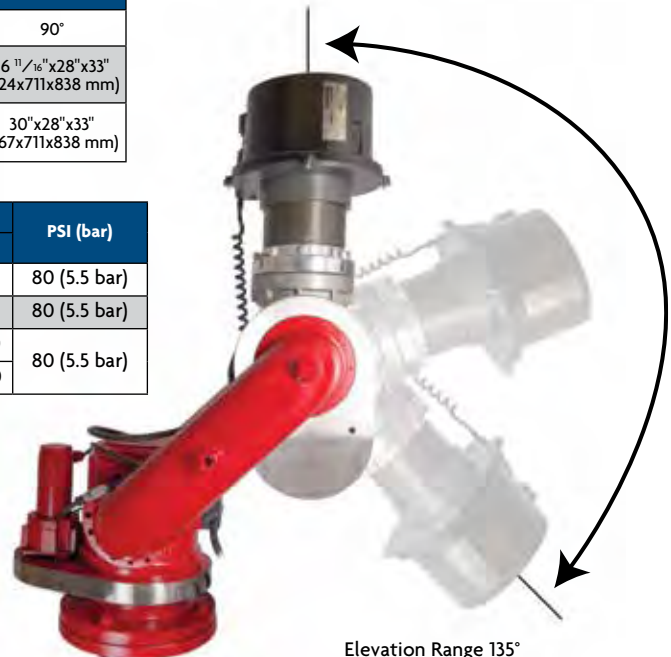

Elevation Range 135°

See Page 51, 172 for Electric Monitor Accessories



## Universal II Monitor Control System

The Universal II Monitor Control System is the highest performing most technologically advanced monitor control system. The Universal II Control System is an intelligent embedded controller compatible with both CAN and V-MUX® multiplexed networks simplifying installation while greatly expanding user configurable options and interfaces. This system's unique design empowers you to configure your monitor system giving you simplified and total control.

- “Plug and Play” for simplified installation
- V-MUX & CAN (J1939) Compatible
- Field Upgradeable Software
- Modular Design for Simplified Maintenance
- Onboard Diagnostic Capabilities
- Real Time Monitor Position Feedback \*
- Proportional Speed Controls
- IP67 Rated Enclosure for Water & Corrosion Resistance

Style 6032  
Universal II  
Logic Box



\* Optional - Must specify

### HARNESSES FOR CONNECTING UNIVERSAL II CONTROLLER TO CAN DEVICES

Item	Description	Length	Part Number
1	Receptacle Connector – CAN “Y” Adapter (Deutsch #DT04-3P-P007). Connects together two CAN Network Harnesses and one CAN Stub Harness.		758306
2	Plug Connector – CAN 120Ω Terminator (Deutsch #DT06-3S-PP01). Two are required per system and plug into the CAN “Y” Adapters at each end of the CAN network.		742205
3	CAN Network Harness – Extends the CAN network to a CAN node device (an operator station for example). Connects between two CAN “Y” Adapters.	½ ft. ( 0.15 m) 2 ft. ( 0.61 m) 3 ft. ( 0.91 m) 5 ft. ( 1.52 m) 10 ft. ( 3.05 m) 20 ft. ( 6.10 m) 30 ft. ( 9.14 m) 40 ft. (12.19 m)	721659 721667 721572 721573 721574 721570 721665 721575
4	CAN Stub Harness – Connects the CAN network to the 6032 Universal II Controller	3 ft. ( 0.91 m)	721582
5	CAN Stub Harness – Connects the CAN network to a 6035 Joystick, 6041 Switch Box or 6036 Direction Indicator. Includes power and ground wires for connecting power to the control devices.	3 ft. ( 0.91 m) 10 ft. ( 3.05 m)	721579 721677
6	CAN Stub Harness – Connects the CAN network to a 6037 CAN Wireless Module. Includes power and ground wires for connecting power to the module. Also includes four wires for switch inputs and two wires for digital outputs.	3 ft. ( 0.91 m)	721580
7	CAN Stub Harness – Connects the CAN network to a 3406 Electric Riser via the 6033 Mini Universal Controller. Includes four wires for the Extend and Retract Relay contacts.	3 ft. ( 0.91 m)	721594

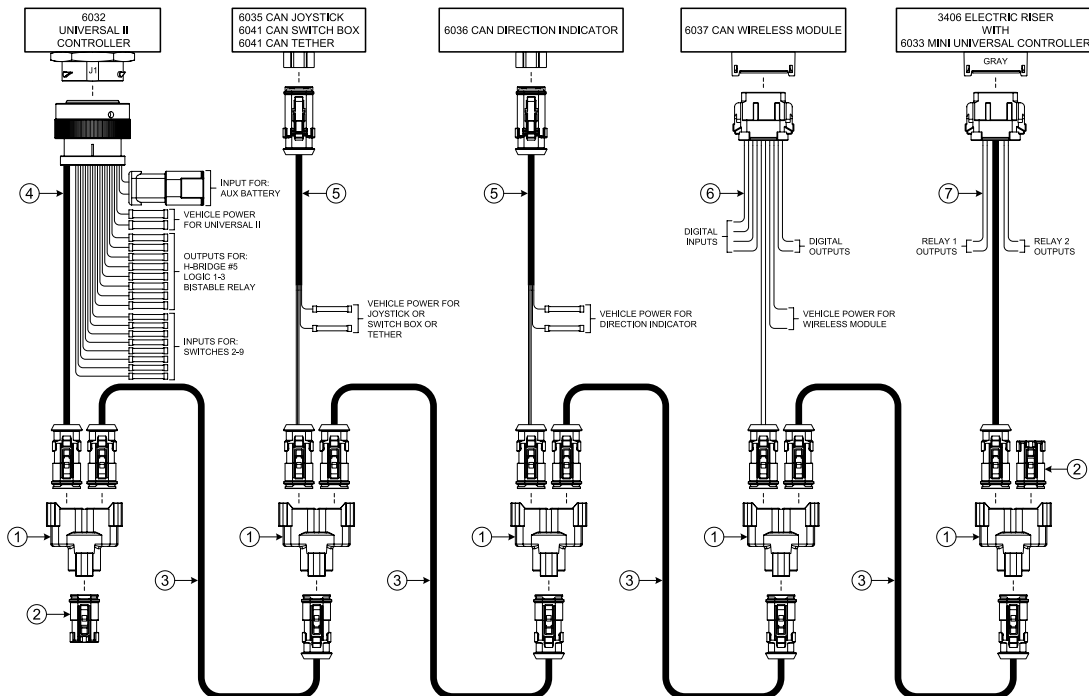





## Standard Controls

6035009  
CAN Proportional  
Joystick



60410023



60410008

## Universal II Electric Monitor Optional Accessories

Switch Interface  
Transmitter  
(SIT) Module  
36000004



Style 60370008  
CAN Wireless  
Receiver Interface



WRC - Hand  
Held Controller  
36000015



60412001  
CAN Teather



60510005 Panel Mount  
Interface for use  
with 60412001



Style 6036  
CAN Direction  
Indicator



60350017  
Point-Aim Joystick



60350012 ARFF  
CAN Joystick



60410035  
OEM Interface  
Module



60510002  
CAN Gateway  
Module



60510006  
CAN Repeater



60411005



60410029



60410034



60411003



60410028



60411000



## Mercury™ Quick Attack Monitor 500 GPM (1900 LPM)

The Mercury Monitors are smaller than any other portable ground monitor so they can be quickly set up and left unmanned at the fire scene to free up valuable personnel.

### 3443 Mercury Quick Attack Monitor

- Rated flows up To 500 gpm (1900 lpm)
- Quick deployment
- Unmanned use
- Rotation ± 20°
- Elevation 30° to 60° unmanned, and down to 20° when manned



Style 3443 Shown with Style 4445 Nozzle



Style 5148 Oscillating MercuryMaster Nozzle



Storage Bracket



Style 2420



Style 489



Style 1545



Styles 4445, 4447 Compatible with 3621 Foam Tube

Style	Weight lbs. (kg)	Height	Width	Depth	Inlet	Outlet	Flow	
							GPM	LPM
3443	14 † (6.4 kg)	9 5/8" (245 mm)	23 1/8" (588 mm)* 7 13/16" (199 mm)**	14 9/16" (370 mm)*	2 1/2" F (65 mm) 2 1/2" or 3" Storz (65 or 75 mm)	2 1/2" (65 mm)	500	1900

\*Deployed Legs

\*\* Folded Legs

† Less Nozzle

## MercuryMaster 1000™ 1000 GPM (3800 LPM)

The MercuryMaster 1000 is the smallest and lightest of all 1000 gpm monitors in the firefighting industry. This monitor will save valuable time at the fire scene with quick deployment and conserves precious space on the fire truck with its compact size.

### 3446 MercuryMaster 1000

- Rated flow up to 1000 gpm (3800 lpm)
- Rotation ± 20°
- Elevation 30° to 60°
- Unmanned use
- Low friction loss
- Pressure gauge
- Available less Stream Shaper for CAFS applications

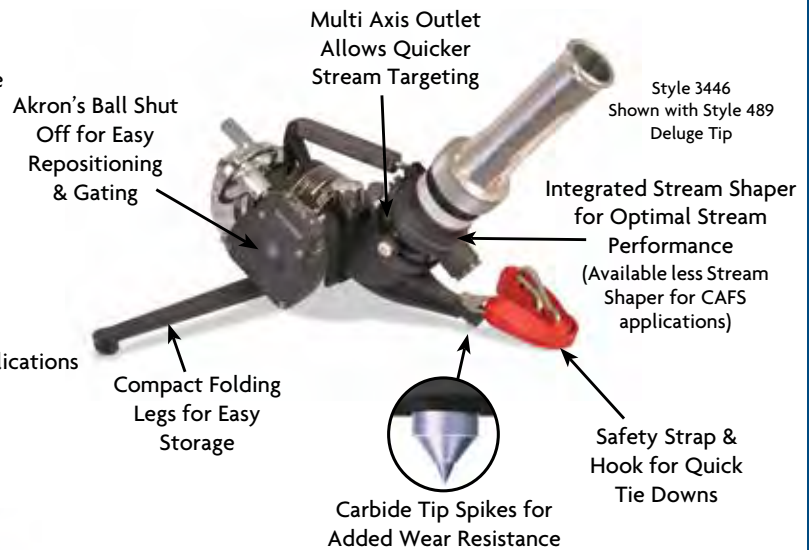

Style 3446 Shown with Style 489 Deluge Tip



Style 3446 Shown with Style 5148 Oscillating MercuryMaster Nozzle



Style 5148 Oscillating MercuryMaster Nozzle



Style 2498



Style 5147 Adjustable Manual MercuryMaster Nozzle



Style 5150 Automatic Nozzle



Storage Bracket

Style	Weight lbs. (kg)	Height	Width	Depth	Inlet	Outlet	Flow	
							GPM	LPM
3446 Single	24 (10.8 kg)	11 1/16" (281 mm)	25"* (635 mm) 10 1/8"*** (257 mm)	16 3/16"* (410 mm)	3 1/2 - 5" F (89-125 mm) 4", 5" Storz (100, 125 mm)	2 1/2" (65 mm)	1000	3800
3446 Dual	24 (10.8 kg)	11 1/16" (281 mm)	25"* (635 mm) 12 1/2"*** (318 mm)	21 5/16" (541 mm) 22 7/16" (570 mm) BIM 21 13/16" (554 mm) STORZ	2 1/2 or 3" F (65 or 75 mm)	2 1/2" (65 mm)	1000	3800

\*Deployed Legs

\*\* Folded Legs



## Ozzie™ 911 Oscillating Monitor 350 GPM (1325 LPM)

The Akron® Ozzie 911 Oscillating Monitor has a powerful sweeping water stream for high performance attack and protection. Its unique water driven motor sweeps the outlet back and forth in a smooth, wave-like motion to provide cooling and protection while unmanned. The Ozzie Oscillating Monitor operates by itself to provide greater flexibility by protecting exposures while personnel work elsewhere. The Ozzie 911 Oscillating Monitor is suited for haz-mat situations, protecting exposures, and attacking fires.

### 911 Ozzie Oscillating Monitor

- Adjustable sweeping range 30° either side of center
- Vertical travel from 35° to 90° above horizontal
- On/Off knob can stop oscillation at any point
- Built-in pressure gauge
- See page 171 for Monitor/Fog Nozzle Compatibility Chart



Style 911  
Shown with Style 4827 Tip



Style	Weight lbs. (kg)	Height	Width	Depth	Inlet	Outlet	Flow	
							GPM	LPM
911	29* (13 kg)	13 3/8" (340 mm)	23 3/4" (603 mm)	19 1/4" (490 mm)	2 1/2" (65 mm)	1 1/2" (38 mm)	350	1325

\* Less nozzle

\*\* When purchased with CE approved nozzle

## Ozzie™ Master 922 Oscillating Monitor 1250 GPM (4800 LPM)

The Akron® Ozzie Master 922 Oscillating Monitor has a powerful sweeping water stream for high performance attack and protection. Its' unique water-driven motor sweeps the outlet back and forth in a smooth, wave-like motion to provide cooling and protection while unmanned. The Ozzie Master Oscillating Monitor operates by itself to provide greater flexibility by protecting exposures while personnel work elsewhere. Ozzie Oscillating Monitors are suited for haz-mat situations, protecting exposures, and attacking fires.

### 922 OzzieMaster™ Oscillating Monitor

An Ozzie Liftoff designed for use with an Apollo™ Single or Dual Inlet Ground Base, See page 55

- Adjustable sweeping range 25° either side of center
- Vertical travel from 45° to 90° above horizontal
- On/Off knob can stop oscillation at any point
- Built-in pressure gauge
- See page 171 for Monitor/Fog Nozzle Compatibility Chart



Style 922  
Shown with Style 1745 TurboMaster™ Master Stream Nozzle mounted on Apollo Single Inlet Ground Base

Style	Weight lbs. (kg)	Height	Length	Width	Inlet	Outlet	Ground Flow		Deck Flow	
							GPM	LPM	GPM	LPM
922	27 1/2** (12.5 kg)	13*** (330 mm)	21" (533 mm)	17 3/4" (450 mm)	See Apollo Inlet Options	2 1/2" (65 mm)	1000 Single Inlet 750 Dual Inlet	3800 Single Inlet 2900 Dual Inlet	1250	4800

\* Less ground bases and nozzle

\*\* When purchased with CE approved nozzle

\*\*\* Liftoff only, does not include direct mount flange or adapter

NOTE: A direct mount flange allows the OzzieMaster Oscillating Monitor to be used as a deck monitor.

# Municipal Portable and Truck Monitors

## Apollo™ Monitor 1250 GPM (4800 LPM)

Akron® Apollo Monitors offer a variety of models with features to fit the ever increasing demands of the fire service with a durable, dependable and stable monitor.

- 360° rotation when mounted in the deck mode, 180° in the portable mode
- Vertical travel from 90° above to 15° below horizontal, with built-in 35° safety stop
- 3" waterway with cast-in turning vanes for efficient flow
- Direct mount - a combination 3" NPT female and 3" flange
- Carbide spikes for extended wear (Spike covers optional)
- Also available as portable only or deck mount only - must specify
- See page 171 for Monitor/Fog Nozzle Compatibility Chart



Style 3416  
Shown with Style 5160 Akromatic®  
Master Stream Nozzle



Style 3423  
Shown with Style 3488  
Discharge Pipe & Style 2499  
Quad Stacked Tips

**3414 Apollo Single Inlet Portable Monitor**  
• Includes a ground base and liftoff



**3421 Apollo Dual Inlet Portable Monitor**  
• Includes a ground base and liftoff



**3416 Apollo Single Inlet Portable and Deck Monitor**  
• Includes a ground base, liftoff and direct mount



**3423 Apollo Dual Inlet Portable and Deck Monitor**  
• Includes a ground base, liftoff and direct mount



NOTE: Available in deck only configurations - Must specify

Style	Weight lbs. (kg)		Deck Height	Deck Width	Deck Depth	Inlet	Outlet	Ground Flow		Deck Flow	
	Liftoff	Gd Base						GPM	LPM	GPM	LPM
3414/ 3416	23 (10.4 kg)*	38 1/2 (17.5 kg)	** 12 11/16" (305 mm)	13" (331 mm)	23 1/2" (597 mm)	3 1/2" - 5" F (89-125 mm) 4", 5" STORZ (100, 125 mm)	2 1/2" Male (65 mm)	1000	3800	1250	4800
3421/ 3423	23 (10.4 kg)*	32 (14.5 kg)	** 12 11/16" (305 mm)	13" (331 mm)	23 1/2" (597 mm)	2 1/2" or 3" F (65 or 75 mm)	2 1/2" Male (65 mm)	800	3030	1250	4800

\* Less nozzle

\*\* Measured from flange base to the top of the liftoff (Excludes nozzle or tips), Elevation Elbow extends 1" (25 mm) below flange base



## Apollo PE™ Monitor 1250 GPM (4800 LPM)

The Style 3419 Apollo PE (Portable Electric) has flow capabilities of 1250 gpm (4800 lpm) with a self-contained battery and electronic control system. The Apollo PE offers motorized rotation, elevation, and nozzle pattern control. Programmable oscillation from 0-180 degrees in portable mode, 0-355 degrees in truck mode and RF wireless remote control are key features that allow for operation from safe distances using less manpower in fire or Haz-Mat situations. This robust monitor also features a smart ground mode configuration system which automatically positions the monitor for ground base installation. A quick change battery system allows for extended run times and is compatible with 12 or 24 volt systems.

- Flow capabilities of 1250 gpm (4800 lpm)
- Completely sealed, waterproof connectors
- Programmable oscillation
- Integrated and sealed electronics
- RF wireless control
- 12V or 24V compatible in one unit
- Quick change rechargeable battery system for truck and portable applications
- Simple “plug and play” installation
- Uses standard Apollo ground bases



Style 3419  
Shown with 5177 1250  
gpm Nozzle



Style 3600  
Wireless Remote

Style 6035  
CAN Joystick



Style 6041  
CAN Panel Mount  
Control



Style 3419  
Direct Mount  
Flange



Style  
2499



Style  
2498



Style 1578  
SaberMaster  
Nozzle



Style 5177 Nozzle



Style  
3485

### Additional Options:

- Style 6035 - CAN proportional speed joystick
- Style 6041 - CAN panel mount control station
- Style 6045 - Spare battery with storage/charging bracket
- Style 3419 – Direct mount with elevation stop interlock

### Nozzle Options:

- Style 5177 Akromatic 1250
- Style 2499 quad stacked tips, with 3485 mini shaper
- Style 2498 triple stacked tips, with 3485 mini shaper

Style	Weight lbs. (kg)		Deck Height	Deck Width	Deck Depth	Inlet	Outlet	Ground Flow		Deck Flow	
	Liftoff	Ground Base						GPM	LPM	GPM	LPM
3419	45 (20.5 kg)*	Single Inlet 38 1/2 (17.5 kg)	13" (331 mm)	15" (381 mm)	18 3/8" (467 mm)	Single Inlet 3 1/2" - 5" F (89-125 mm) 4", 5" STORZ (100, 125 mm)	2 1/2" Male (65 mm)	Single Inlet 1000	Single Inlet 3800	Single Inlet 1250	Single Inlet 4800
		Dual Inlet 32 (14.5 kg)						Dual Inlet 800	Dual Inlet 3030	Dual Inlet 1250	Dual Inlet 4800

\* Less nozzle





## Apollo Hi-Riser™ Monitors 1250 GPM (4800 LPM)

The Apollo Hi-Riser includes the outstanding features of the standard Apollo along with the added benefit of rising over obstacles on top of the apparatus. To elevate the Apollo Hi-Riser, simply pull a pin and raise the discharge 24" above the deck. Also, the Apollo Hi-Riser rotates easily down to a low profile position for portable operation and comes complete with an automatic drain valve.

### 3431 Apollo Hi-Riser Single Inlet Portable and Deck Monitor

- Includes single inlet ground base, liftoff and direct mount
- Available in deck only configurations - Must specify



### 3433 Apollo Hi-Riser Dual Inlet Portable and Deck Monitor

- Includes a dual inlet ground base, liftoff and direct mount



Patented 6,109,360

Style 3431/3433  
Shown in deck mount mode with  
Style 5160 Akromatic Master  
Stream Nozzle

Style	Weight lbs. (kg)		Deck Height	Width **	Depth**	Inlet	Outlet	Ground Flow		Deck Flow	
	Liftoff	Gd Base						GPM	LPM	GPM	LPM
3431	31 * (14.1 kg)	38 1/2 (17.5 kg)	** 15 1/4" (387 mm)	14 9/16" (370 mm)	18 5/8" (473 mm)	3 1/2" - 5" F (89-125 mm) 4" 5" STORZ (100, 125 mm)	2 1/2" Male (65 mm)	1000	3800	1250	4800
3433	31 * (14.1 kg)	32 (14.5 kg)	** 15 1/4" (387 mm)	14 9/16" (370 mm)	18 5/8" (473 mm)	2 1/2" or 3" F (65 or 75 mm)	2 1/2" Male (65 mm)	800	3030	1250	4800

\* Less nozzle

\*\* Stowed position, measured from base of flange to top of lift off, elevation elbo extends 2" (50 mm) below flange base

## Apollo Base Mounts

### 3503 Apollo Top Mount

- Easily mounts the Apollo on top of a vehicle for deck gun operation or storage on a vertical surface
- Size: 22" x 15 1/4", weight: 7 1/2 lbs.

### 3505 Mount for Apollo Ground Base

- Conveniently store the Apollo ground base with folding legs in a standard apparatus compartment
- Length: 10", thickness: 2 1/2", weight: 1 5/8 lbs.



## GP Manual Monitor 1000 GPM (3800 LPM)

The GP Manual Monitor is one of the most cost effective, highest performing firefighting monitors found worldwide. This monitor's rugged, lightweight design was engineered using some of the world's most advanced computer aided design and testing technology, resulting in performance seen by no other 1000 gpm (3800 lpm) monitor today. Once you grab the dual handled controls, you will know you are using the most highly maneuverable, easiest operating, most versatile fire service monitor in the world.

### 3430 GP Manual Monitor

- Rated flow up to 1000 gpm (3800 lpm)
- Rotation Continuous 360°
- Elevation +90° to -45°
- Cast-in turning vanes & integrated removable stream shaper for maximum reach and stream performance
- Built-in pressure gauge
- "T" handle manual control provides precise, easy positioning and control
- Compact, efficient design requires minimum mounting space
- See page 170 for Monitor/Fog Nozzle Compatibility Chart



Style 3430  
with 487 GP  
Smooth Bore Tip

Style	Weight Lbs.	Height	Width	Depth	Inlet	Outlet	Flow	
							GPM	LPM
3430	15.4 lbs (7 kg)	13 1/4" (337mm)*	11" (279mm)	9 13/16" (250 mm)	3"-4" Flange (75-100 mm) DN80-100 Flange 2 1/2 - 3" NPT or BSP	2 1/2" NH (65 mm)	1000	3800

\* Less Tiller Bar

## Gemini™ Monitor 1000 GPM (3800 LPM)

The Gemini Monitor is of Pyrolite® construction with a compact split waterway designed with cast-in turning vanes providing performance and exceptional durability.

### 3470 Handwheel Gemini Monitor

- 360° continuous horizontal rotation
- Self-locking handwheel for horizontal and vertical travel
- Built-in pressure gauge with gauge guard
- See page 170 for Monitor/Fog Nozzle Compatibility Chart

Style	Weight lbs. (kg)	Height	Width	Depth	Inlet	Outlet	Flow	
							GPM	LPM
3470	25 (11.3 kg)	20" (508 mm)	12 1/4" (312 mm)	14 5/16" (364 mm)	3" - 4" (75-100 mm) NPT or FL	2 1/2" (65 mm)	1000	3800



Style 3470  
Shown with Style  
3488 Discharge Pipe  
& Style 489 Tip



### Ladder Pipes 750/1000 GPM (3000/3800 LPM)

The Akron® Ladder Pipe offers a lightweight, compact design for uniped ladder trucks.

#### 1495 Ladder Pipe 1000 GPM (3800 LPM)

- New easy adjustable mounting clamp with safety pins for more secure mounting
- Horizontal lock permits 15° sweep either side of center
- Removable control handle adjusts to 12 positions
- Lightweight extruded aluminum discharge pipe with full-length stream shaping fins
- 200 ft. 3/8" No. 1 Grade pure manila rope
- Adjustable mounting clamps for round rung ladders, square clamps available - Must Specify
- Optional 14950007 Mounting fixture - Must Specify

#### 1496 Classic Ladder Pipe 750 GPM (3000 LPM)

Style	Weight lbs. (kg)	Length	Width	Depth	Inlet	Outlet	Flow	
							GPM	LPM
1495	27 (12.3 kg)	39 7/8" * (1013 mm)	14 1/8" * (359 mm)	9 1/8" * (232 mm)	2 1/2" or 3" (65 or 75 mm)	2 1/2" (65 mm)	1000	3800
1496	23.5 (10.7 kg)	38" (965 mm)	17" (432 mm)	11 1/2" (292 mm)	2 1/2" or 3" (65 or 75 mm)	2 1/2" (65 mm)	750	3000

\* Less Nozzle



Style 1495  
Shown with  
Style 489 Tip and  
Discharge Pipe

### Apollo™ Single Waterway Monitors 1250/2000 GPM (4800/7600 LPM)

- Designed for fixed installations in non-corrosive environments
- Durable lightweight Pyrolite® construction
- Cast-in turning vanes in each elbow for more efficient flow and improved stream performance
- 360° horizontal and 150° vertical travel
- Elevation 90° above to 60° below horizontal
- See page 170 for Monitor/Fog Nozzle Compatibility Chart

#### 3426 3" Apollo Single Waterway Monitor

- A friction lock on both the vertical and horizontal travel
- Built-in pressure gauge and gauge guard

Style 3426  
Shown with Discharge Pipe  
Style 3488 & Tip Style 489

Style	Weight lbs. (kg)	Height	Width	Depth	Inlet	Outlet	Flow	
							GPM	LPM
3426	21 (9.5 kg)	17" (431 mm)*	12 3/8" - 15 1/8" (315 - 385 mm)	32 3/4" (832 mm)	2 1/2" - 3" (65-75 mm) NPT or FL	2 1/2" (65 mm)	1250	4800

\* Not including tiller bar



### StreamMaster™ II Manual Monitors 1250/2000 GPM (4800/7600 LPM)

The StreamMaster II manual monitor is taking monitor design technology to the next level. Included in its patented design is a unique waterway construction capable of flows from 250 gpm (950 lpm) up to 1250 gpm (4800 lpm). For the 3483 or 500-2000 gpm (1900-7600 lpm) for the 3481. This waterway provides balanced forces on the outlet and reduced friction loss resulting in exceptional stream performance over this wide-range of flows in a small compact package. This dual handwheel controlled monitor is suited for large flow needs in fire apparatus and fixed site installations.

- Compact industry leading operating envelope (10.5", 266.7 mm)
- Easy handwheel operation of both horizontal and vertical travel
- Rotational Range: 355°
- Elevation 45° below to 90° above horizontal
- See page 170 for Monitor/Fog Nozzle Compatibility Chart

#### 3481 4" Flange inlet, 3 1/2" NH outlet up to 2000 gpm flow

Style	Weight * lbs. (kg)	Height	Width	Depth	Inlet	Outlet	Flow	
							GPM	LPM
3481	33.3 (15.1 kg)	18 1/4" (464 mm)	11 3/4" (298 mm)	12 7/16" (316 mm)	4" Flange (DN100)	3 1/2" Male (89 mm)	2000	7600

\* Less nozzle



Style 3481  
Shown with  
Style 5170 Nozzle







Corrosion resistant monitors with maximum travel for optimal coverage in industrial, mining and marine environments.

### Severe-Duty Monitor 750 GPM (2900 LPM)

The Severe-Duty, multi-purpose monitor is designed to withstand continuous operation while mounted on heavy-duty equipment like off-road fire, construction, mining, or landfill vehicles. Dusty, dirty, outdoor, and continuous vibration applications are what this Akron Brass severe-duty monitor is designed to survive. The Severe-Duty monitor is excellent for fixed site non-classified wash down or fire protection.

#### 3491 Severe-Duty Electric Monitor

- 12/24 volt motor (Must specify)
- Stainless construction
- Auto Oscillation
- 320° rotation
- 155° elevation (+90°, -65°)
- Fast travel, 20°/ sec
- Pressures up to 200 psi
- 2 1/2" waterway (65 mm)
- Reaches 200' at 750 gpm
- See page 171 for Monitor/Fog Nozzle Compatibility Chart

#### Control Options:

- Joystick Control
- Toggle Switch Control
- Custome Control Panel
- Wireless

See Page 51, 172 for Electric Monitor Accessories

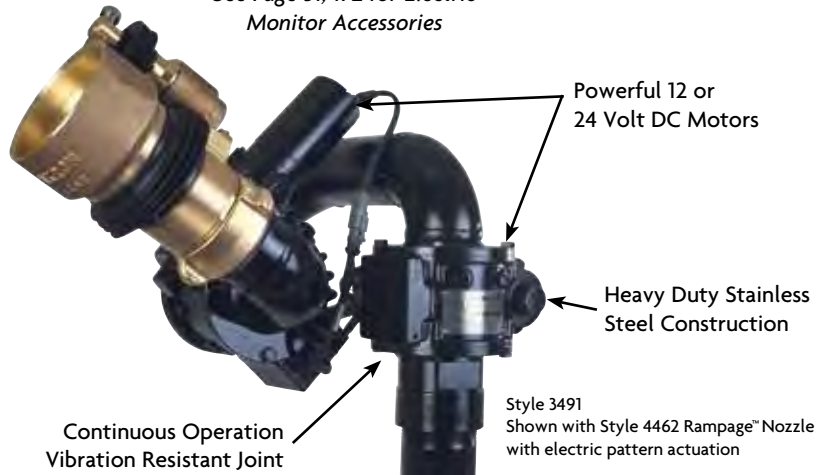

Style 3293 Nozzle



Wireless Remote Control Available



Style 489 Tip

Style	Weight lbs. (kg)	Height	Width	Depth	Inlet	Outlet	Flow	
							GPM	LPM
3491	57 (25.6 kg)*	10" (254 mm)	10 1/2" (267 mm)	11 1/2" (292 mm)	2 1/2" NPT (65 mm) 3" FL (75 mm)	2 1/2" NH (65 mm)	750	2900

\* Less nozzle





Corrosion resistant monitors with maximum travel for optimal coverage in industrial, mining and marine environments.

## Severe-Duty Monitor 750 GPM (2900 LPM)

The Severe-Duty, multi-purpose monitor is designed to withstand continuous operation while mounted on heavy-duty equipment like off-road fire, construction, mining, or landfill vehicles. Dusty, dirty, outdoor, and continuous vibration applications are what this Akron Brass severe-duty monitor is designed to survive. Excellent for fixed site non-classified wash down or fire protection.

### 3492 Severe-Duty Hydraulic Monitor

- Hydraulic motor flow 1/2 gpm @ 500 psi
- Stainless construction
- 320° rotation
- 155° elevation (+90°, -65°)
- Fast travel, 20°/ sec
- Pressures up to 200 psi
- 2 1/2" waterway (65 mm)
- Reaches 200' at 750 gpm (2900 lpm)
- See page 171 for Monitor/Fog Nozzle Compatibility Chart



Style	Weight lbs. (kg)	Height	Width	Depth	Inlet	Outlet	Flow	
							GPM	LPM
3492	59 (26.7 kg)	10" (254 mm)	10 1/2" (267 mm)	11 1/2" (292 mm)	2 1/2" NPT (65 mm) 3"FL (75 mm)	2 1/2" NH (65 mm)	750	2900

## Gemini™ Monitor 1000 GPM (3800 LPM)

The Gemini Hydraulic Monitor is of Pyrolite® or brass construction with a compact split waterway designed with cast-in turning vanes. The Gemini Monitor provides high performance and exceptional durability.

- 135° vertical travel: 45° below to 90° above horizontal
- 360° continuous horizontal rotation due to innovative rotation joint design
- Manual override standard
- See page 171 for Monitor/Fog Nozzle Compatibility Chart

### 3476 Brass Hydraulic Gemini Monitor

Style	Weight lbs. (kg)	Height	Width	Depth	Inlet	Outlet	Flow	
							GPM	LPM
3476	82 (37.3 kg)	20" (508 mm)	10 1/4" (260 mm)	15 1/8" (385 mm)	3" - 4" (75-100 mm) NPT or FL	2 1/2" (65 mm)	1000	3800



Style 3476 Shown with Style 5056 Nozzle





### Omega™ XP Monitor 1250 GPM (4800 LPM)

The Omega XP brass monitor offers maximum travel for optimal coverage in industrial and marine environments.

#### 3528 Omega XP Monitor

- Brass construction for corrosion resistance
- Cast-in turning vanes for more efficient flow
- Unique locking mechanism to hold desired position
- Enhanced design provides less tip weight which translates to lower handle operating force
- 360° of horizontal movement and 135° of vertical movement
- Elevation 90° above to 45° below horizontal
- Maximum operating pressure of 200 psi
- Maximum flow 1250 gpm (4800 lpm)
- See page 171 for Monitor/Fog Nozzle Compatibility Chart



Style 3528  
Shown with  
Style 4450 Nozzle

Style	Weight lbs. (Kg)	Height	Width	Depth	Inlet	Outlet	Flow	
							GPM	LPM
3528	55* (24.9 kg)	14"*** (356 mm)	9 3/4" (248 mm)	9 3/4" (248 mm)	3" or 4" FL (75 or 100 mm)	2.5" NH (65 mm)	1250	4800

\* Less nozzle      \*\* Less handle

### Omega™ XPV Monitors 1250 GPM (4800 LPM)

The Omega XPV brass monitors have a built-in valve for optimal versatility in industrial and marine environments.

#### 3523 Omega XPV Monitor

- Brass construction for corrosion resistance
- Cast-in turning vanes for more efficient flow
- Unique locking mechanism to hold desired position
- Built-in 3" Heavy-Duty Swing-Out™ valve
- Enhanced design provides for less tip weight which translates to lower handle operating force
- 360° of horizontal movement and 135° of vertical movement
- Elevation 90° above to 45° below horizontal
- Maximum operating pressure of 200 psi
- Maximum flow 1250 gpm (4800 lpm)
- See page 171 for Monitor/Fog Nozzle Compatibility Chart



Style 3523  
Shown with  
Style 2151 Nozzle

**Incorporates Akron's proven Generation II Heavy-Duty™ Swing-Out Valve technology**

- Unique 316 grade stainless steel ball - designed for superior gating
- 90° adjustable handle travel
- No lubrication or regular maintenance required
- Designed to exceed NFPA requirements

Style	Weight lbs. (kg)	Height	Width	Depth	Inlet	Outlet	Flow	
							GPM	LPM
3523	84 lbs* (38.2 kg)	21 3/16"*** (538 mm)	16 1/4" (413 mm)	9 3/4" (248 mm)	3" or 4" FL (75 or 100 mm)	2.5" NH (65 mm)	1250	4800

\* Less nozzle & handle



## Omega™ SD Severe-Duty Monitor 1250 GPM (4800 LPM)

### 3524 Omega SD Severe-Duty Monitor

- Ideal for high usage applications
  - Mining
  - Tank Cleaning
  - Equipment Wash Down
- Extensive duty-cycle use
- Brass & stainless steel construction
- Cast-in turning vanes
- Unique severe-duty joint design
- See page 171 for Monitor/Fog Nozzle Compatibility Chart

#### Product Ratings:

- Maximum Flow: 1250 gpm (4800 lpm)
- Maximum Pressure: 200 psi (13.79 bar)
- Articulation:
  - 360° Horizontal 90° to +90° vertical travel
  - Elevation 90° below to 90° above
- Friction Loss 12 psi @ 1000 gpm



Style 3524  
Shown with  
Style 499 Triple Stacked  
Deluge Tips

Style	Weight lbs. (kg)	Height	Width	Depth	Inlet Standard	Inlet Optional	Outlet	Flow	
								GPM	LPM
3524	58.5 (26.5 kg)	13 15/16" * (354 mm)	14 3/16" * (360 mm)	26 5/8" (676 mm)	3" (75 mm)	3" or 4" FL (75 or 100 mm)	2.5 NH (65 mm)	1250	4800

\* Maximum dimensions, less nozzle

## Omega™ Monitor 1250 GPM (4800 LPM)

### 3526 Omega Monitor

- Full 3" waterway
- Brass construction
- Cast-in turning vanes for more efficient flow
- 360° horizontal and 150° vertical travel
- Elevation 90° above to 60° below horizontal
- See page 171 for Monitor/Fog Nozzle Compatibility Chart



Style 3526  
Shown with  
Rampage™ nozzle

Style	Weight lbs. (kg)	Height	Width	Depth	Inlet	Outlet	Flow	
							GPM	LPM
3526	72 (32.7 kg)	17" * (432 mm)	11 1/2" * (292 mm)	32 3/4" * (832 mm)	2 1/2", 3" or 4" FL (65, 75 or 100 mm)	2 1/2" (65 mm)	1250	4800

\* Maximum dimensions, less nozzle

## Aries™ Monitor 1250 GPM (4800 LPM)

### 3525 Aries Monitor

- Single handwheel brass monitor
- Cast-in turning vanes for more efficient flow
- 360° horizontal travel
- Elevation 90° above to 60° below horizontal
- Full 3" waterway
- Optional drain valve - Must specify
- See page 171 for Monitor/Fog Nozzle Compatibility Chart



Style 3525  
Shown with Style 4450  
Aquastream™ Nozzle



Style	Weight lbs. (kg)	Height	Width	Depth	Inlet	Outlet	Flow	
							GPM	LPM
3525	66 (30 kg)	15" (380 mm)	14" (550 mm)	17 1/2" (445 mm)	3" or 4" FL (75 or 100 mm)	2 1/2" (65 mm)	1250	4800



### Omega™ Monitor 2000 GPM (7600 LPM)

3437

#### Omega Monitor

- Full 4" waterway
- Gas spring for better balance with various nozzle weights
- Brass Construction
- Cast-in turning vanes for more efficient flow
- 360° horizontal and 150° vertical travel
- Elevation 90° above to 60° below horizontal
- See page 171 for Monitor/Fog Nozzle Compatibility Chart

Style	Weight lbs. (kg)	Height	Width	Inlet	Outlet	Flow	
						GPM	LPM
3437	114 (51.7 kg)	18 1/4" (464 mm)	17 1/2" (445 mm)	4" FL (100 mm)	3 1/2" NPSH (89 mm) 4" NH (100 mm)	2000	7600



Style 3437  
Shown with  
Style 3488 Discharge  
Pipe and Style 489 Tip

### Conquest™ Monitor 2000 GPM (7600 LPM)

A dual handwheel brass monitor with cast-in turning vanes for industrial fires and vapor releases.

3671

#### Dual Handwheel Conquest Monitor

- Low friction loss
- Full 4" waterway
- 12 volt electric version available
- Elevation 90° above to 85° below horizontal
- See page 171 for Monitor/Fog Nozzle Compatibility Chart

Style	Weight lbs. (kg)	Height	Width	Depth	Inlet	Outlet	Flow	
							GPM	LPM
3671	185 (48 kg) *	25 1/2" (648 mm)	26" (661 mm)	19 3/8" (492 mm)	4" FL (100 mm)	3 1/2" NH (89 mm)	2000	7600

\* Less nozzle



Style 3671  
Shown with  
Style 5071  
Akromatic®  
Nozzle

### Storm™ Monitor 2000 GPM (7600 LPM)

A dual handwheel brass monitor with cast-in turning vanes for industrial fires and vapor releases.

3690

#### Storm Monitor

- 5" waterway
- 360° rotation
- Vertical travel 85° above to 45° below horizontal
- See page 171 for Monitor/Fog Nozzle Compatibility Chart

Style	Weight lbs. (kg)	Height	Width	Depth	Inlet	Outlet	Flow	
							GPM	LPM
3690	193 (87.5 kg)	49 1/2" (1257 mm)	30 1/2" (775 mm)	31 1/2" (800 mm)	4" FL (101 mm)	3 1/2" NPSH (89 mm)	2000	7600



Style 3690  
Shown with Style 5071  
Akromatic Nozzle



## Conquest™ Electric Remote Controlled Monitor System 2000 GPM (7600 LPM)

The Conquest Electric Remote Controlled Monitor System was designed as a small compact unit with exceptional performance and value. This System is ideal for use in industrial fire suppression, vapor mitigation, and other fixed site applications.

### 3678 Conquest Electric Monitor System

- Brass construction for use in severe environments
- Efficient flows up to 2000 gpm (7600 lpm) through a 4" waterway
- FM approved for NEC Class 1, Div 2, Groups C & D hazardous locations
- ATEX approved for Zone 1, 2, 21, & 22 hazardous locations
- Electric motors with current limiting and dynamic braking
- Fixed or automatic baffle nozzles
- Manual overrides
- Custom Engineered to your specification (Available)



Conquest Drive System

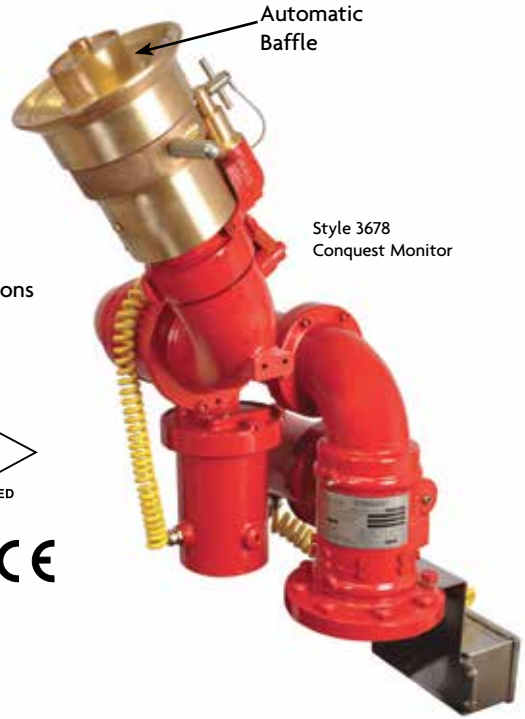

Style 3678  
Conquest Monitor



3678 Conquest	
Material	Cast brass construction
Max. Flow	2000 gpm (7570 lpm)
Inlet	4" 150# Flange
Outlet	3½" NH
Waterway	4" (102mm) diameter internal waterway with turning vanes
Friction Loss	22 psi at 2000 gpm (1.4 bar at 7600 lpm) 6 psi at 1000 gpm (0.42 bar at 3800 lpm)
Rotation	340° rotation.
Elevation	175°, +90° above horizontal to -85° below horizontal.
Motors	AC motors with brass housings for elevation and rotation. Motors are rated for hazardous locations. Motors have manual override for operation during power failures.
Operating Pressure	200 psi max. (14 bar max.)
Dimensions	21½" (546 mm) high, 17" (432 mm) wide (radius of motion), and 14" (356 mm) deep (radius of motion)
Weight	212 lbs. (96 kg)
Max. Reaction Force	1430 Lbf. (6360 N)
Moment at Base Inlet	1907 Lb.-ft. (2585 N-m)
Approvals	ATEX Zone 1 II 2 D Ex tb IIIC T85°C Db (-20° C ≤ Ta ≤ 60°C) ATEX Zone 2 II 3 G Ex nR IIC T6 Gc (-40° C ≤ Ta ≤ 60°C) FM NEC Class 1 DIV2

3678 AC Conquest Motor Drive	
Type	Custom Three Axis AC Motor Drive
Features	Forward and reverse operation for each motor
	Over current and current limiting protection for each motor
	Dynamic braking for each motor
	No holding torque applied to stopped motors.
Enclosures	Manual override capabilities remain when drives are powered
	NEMA 4X, NEMA 7
Operator inputs for control of monitor axis	Inputs from master override slave inputs
	Conflicting inputs are ignored
	Axis control circuitry, for master/slave control panel, is 24VDC
	LED power indicator
Other drive features	LED input indicators
	LED output indicators
	LED status indicators for troubleshooting
	120 VAC input line filter
	15 Amp slow-blow fuse
	+140 to -40 F operating temperature
	Jumper selected "Nozzle return to fog on power down" feature on motor drive
	Finger safe, pluggable socket type, terminal strips used through out
	2 - Auxiliary relays for water on/off, foam on/off or customer selected functions are included
	PC board is coated to resist corrosion
	Three axis drive is a self contained unit which is easily removable for repair/ replacement
	Can be located up to 1000 feet (300 meters) away from the Conquest Remote Controlled Monitor.
Electrical Requirements	120VAC, 10 amp, 60Hz or 240VAC, 5 amp, 50Hz, supplied to the motor drive box. Other voltages available.
Approvals	ATEX Zone 1 – II 2 G Ex d IIB T6 Gb
	ATEX Zone 2 – II 3 G Ex nC IIC T6 Gc
	FM NEC Class 1 DIV2

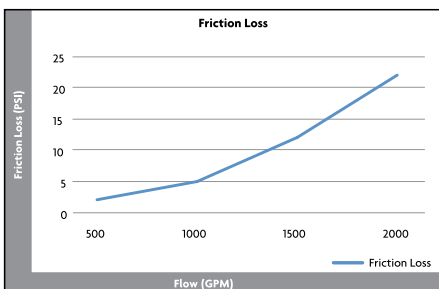



### Storm™ Electric Programmable Monitor System 2000 GPM (7600LPM)

The Storm Electric Programmable Monitor System provides a superior fog curtain and excellent straight stream reach coupled with precision nozzle positioning. This Storm System is designed for industrial fire suppression, vapor mitigation and other harsh environment applications.

#### 3698 Storm Electric Programmable Monitor System

- Brass construction for use in severe environments
- High efficient flows up to 2000 gpm (7600 lpm) through a 5" waterway
- Hazardous environment ratings
- Fully programmable for automated positioning with gas detectors or PLCs
- Precision servo motors and programmable drives for high accuracy positioning
- Fixed or automatic baffle nozzle with wide angle fog pattern for vapor mitigation
- Manual overrides
- Custom Engineered to your specification (Available)



Style 3698  
Storm Monitor



Zone 2

ATEX Zone 2 – II 3 G Ex nA II T165°C (T3)



Storm Drive System

ATEX Zone 2 – II 3 G Ex pz II T6



## Genesis™ Hydraulic Monitor Systems 1250 GPM (4800 LPM)

- Brass or Pyrolite® construction
- Continuous 360° horizontal rotation
- High, efficient flows up to 1250 gpm (4800 lpm) through a 3" (75 mm) waterway
- Fixed or automatic baffle nozzles:  
Style 5056 Automatic, Styles 2156, 2158 Fixed



- 3590 Genesis Hydraulic Manual Monitor System**
- Stand alone or manual override for electric HPU
  - Designed as a replacement for chains and pulleys with hand pump operation



Style 3475  
Genesis Monitor



Style 3590 Genesis Manual HPU



Style 3476 Brass Genesis Monitor

## Typical Remote Controlled Monitor System

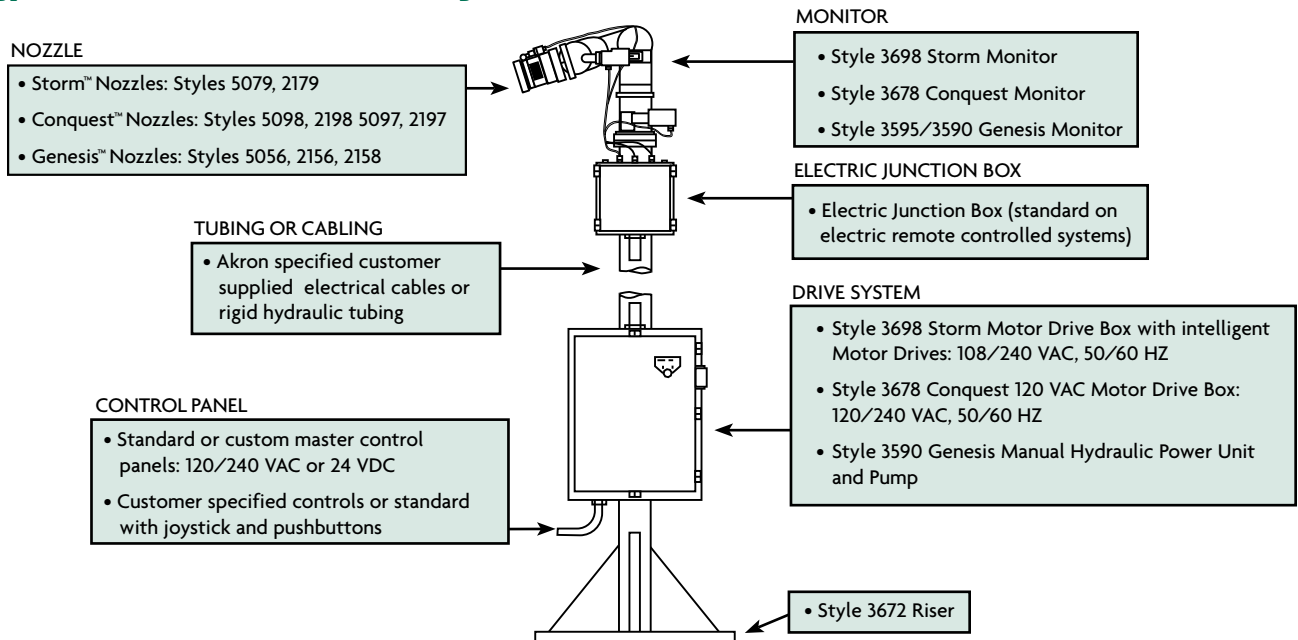

Each Industrial System is custom engineered for specific applications.  
Contact Akron Brass Industrial Systems Group for assistance.  
akroncare@idexcorp.com





## Manual Elevated Monitor 750 GPM (2900 LPM)

Akron Brass' Manual Elevated Monitor is ideal for industrial fixed site applications. Its' unique design features the most compact, simple and efficient elevated monitor without compromising the superior performance you've come to expect from Akron Brass products.

### 3530 Manual Elevated Monitor

- Corrosion resistance materials used throughout
- Heights – 10, 15 and 20 feet (3, 4.5 and 6 m)
- Flow rate – up to 750 GPM (2400 LPM)
- Rotation and elevation – Locking handle at the base of the tower
- Rotation: 360°
- Elevation: 40° (±20° Horizon)
- Nozzle pattern adjustment – cables at the base of the tower
- Optimized nozzle design
  - Excellent reach: 235 feet (72 m) at 750 GPM (2900 LPM)
  - Trouble free pattern actuation
  - Integral stream shaper
- Maintenance free rotation joint design

Style	Weight lbs. (kg)	Height	Width	Inlet	Outlet	Flow	
						GPM	LPM
3530	250* (113.4 kg)	10' (3 m)	26 3/4" (680 mm)	4" FL (100 mm)	2.5" N (65 mm)	750	2900
	326* (147.4 kg)	15' (4.5 m)					
	402* (183 kg)	20' (6 m)					

\* Less Nozzle



Style 3530 Manual Monitor



Elevation Control Handle

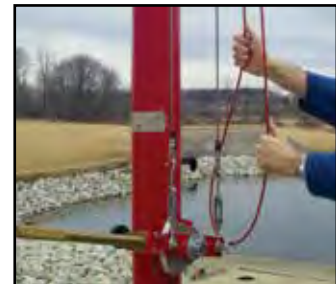

Nozzle Pattern Adjustment Cable

## Tank Wash Down System 500 GPM (1900 LPM)

Akron Brass tank cleaning systems offer a wide range of solutions to improve productivity and reduce equipment down time. Automated tank washing operations often use remote-controlled monitors with programmable controls to quickly and thoroughly clean interior surfaces in railroad tank cars. Monitors may require special materials and seals to withstand various tank contents and washing solutions.

### 3493 Tank Wash Down System

- Stainless Steel, 2.0" diameter waterway
- Flows up to 500 gpm (1900 lpm)
- Severe duty joints
- Programmable – servo motor controlled
- Custom control panels and programs
- Virtually eliminates confined space concerns



Style 3493  
Shown with  
Style 489 Tip

## Large Vehicle And Heavy Equipment Washing 750 GPM (2900 LPM)

Akron's line of heavy-duty vehicle washing water cannons are ideal for routine cleaning of road construction equipment and large on road trucks. Reduce time normally required by current washing methods from hours to minutes with Style 3493 water cannon.

### 3493 Large Vehicle And Heavy Equipment Washing

- Stainless steel, 2.5" diameter waterway
- Flows up to 750 gpm (2900 lpm)
- Severe duty joints
- Simple joystick or fully programmable – servo motor controlled
- Custom control panels and programs



Style 3493  
Shown with  
Style 489 tip



### Crowd Control System

#### 500 GPM (1900 LPM)

The style 3563 is a technologically advanced remote controlled water cannon with features to meet the demands necessary for emergency crowd control. The 3563 can provide continuous flows up to 500 gpm or a pulsing stream up to 200 gpm using the optional high speed pulse-stream valve and joystick. The UII control system provides proportional speed control to the rotation and elevation motors for quick, precise targeting.



Style 3563 Shown with Style 489 Tip & 3485 Stream Shaper

#### 3563 Crowd Control Truck Water Cannon

- Emergency crowd control
- Quick response
- Proven technology
- Easy to install and maintain
- Optional programmable pulse - Stream Jet
- Faster target acquisition
- Adjustable control system
- 320° Rotation
- 135° Elevation (+45° to -90°)
- Programmable pulse - Stream Jet options
- Position feedback standard (Display optional)

Style	Flow Rate	Max Pressure	Outlet	Inlet	Weight	Travel		Nozzle Options
						Vertical	Horizontal	
3563	500 GPM 100 PSI (1900 LPM @ 7 bar)	200 PSI (14 bar)	2 1/2" (65 mm)	2 1/2" (65 mm)	25 lbs (11 Kg)	-45° - +90°	0° - 320°	Solid bore, Adjustable or fixed flow
3563 With Optional High Speed Valve	200 GPM 100 PSI (750 LPM @ 7 bar)	150 PSI (10 bar)	1 1/2" (38 mm)	2" (51 mm)	25 lbs (11 Kg)	-45° - +90°	0° - 320°	Solid bore, Adjustable or fixed flow



60350017 Point-Aim Joystick

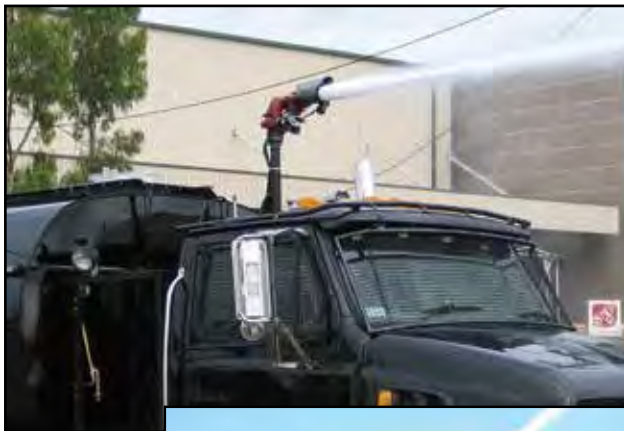

Style 6036 CAN Direction Indicator



Optional high speed valve provides pulses between 1/2 second - 2 1/2 seconds in length or can be used in continuous mode.



## Hydrant Mount 1200 GPM (4500 LPM)

### 2775 Hydrant Mount - Ground Legs

- Hydrant Mount permits a fixed site monitor such as the Aries™ or Omega to be mounted to a 2 1/2" (65 mm) hydrant port
- Height adjustment from the ground to center of the hydrant discharge is 17 1/2" (445 mm) to 28" (712 mm)
- Length: 9 1/2" from the swivel to the middle of flange
- 2 1/2" swivel inlet
- 3" (75 mm) or 4" (100 mm) flange outlet - Must specify
- Weight: 41 lbs. (18.6 kg)
- Maximum operating pressure 100 psi (7 bar)
- Maximum flow 1200 gpm (4500 lpm)



Style 2775  
Shown mounted on a hydrant  
with Style 3526 Omega™  
Monitor (page 57) and Style  
4450 Aquastream Master  
Stream Nozzle

## Oscillating Flange 1500 GPM (5700 LPM)

The Style 3531 Oscillating Flange has been designed, engineered, and tested to protect some of the world's most valuable assets. Its unique maintenance-free polymer bearing design, high quality material construction and superior performance make it the ideal choice for a long-term, low service solution for protecting your hazardous and harsh environments. The Style 3531 is capable of flows to 1500 gpm at an oscillation range up to 165° and is compatible with most Akron Brass manual monitors.

### 3531 Oscillating Flange

- Maintenance-free polymer bearing (no ball bearings)
- Totally water powered (no electrical connections)
- Heavy-duty low friction loss brass waterway
- Stainless steel water drive turbine for long life performance
- Oscillation range: 30°, 60°, 90°, 120°, 140° and 165°
- Adjustable oscillation speed: 0-40 deg. / second
- Operating pressure: 50-250 psi (3 - 17 bar)
- Maximum flow and pressure: 1250 gpm (4800 lpm) @ 250 psi (17 bar) or 1500 gpm (5700 lpm) @ 180 psi (12.5 bar)
- Inlet & outlet: 4" 150# ASA flange
- Weight: 127 lbs (58 kg)
- Integrated test port allows testing of the Oscillating Flange without discharging water from the monitor

Oscillation Range up to 165°



Style 3531  
Patent Pending



\* When Used with FM Approved Monitor and Nozzle

Style 3531 Shown with  
Style 3528 Omega™ XP Monitor  
and Style 4461 Rampage™ Nozzle



 **AKRON**  
BRASS COMPANY

**TEST PORT**  
Close Speed  
Control to Test



Style 3356  
Shown with optional Dry  
Chemical Nozzle and Low  
Profile Rear Inlet





Akron® Roof Turrets offer greater reliability and superior performance when second best is not an option. Akron Turrets come in a variety of roof top designs and flows, either aspirated or non-aspirated, all with easy-to-use controls from inside the truck cab. Our Turrets offer joystick control and adjustable automatic oscillation.

## Trident™ HFRT-10

This roof turret will deliver up to 2000 gpm (7600 lpm). To meet the demands of the industry, multiple control options and a variety of nozzle options are available. All units exceed NFPA 414 and FAA requirements.

### 3356 Trident HFRT-10

- Flow: 350-2000 gpm (1325-7600 lpm)
- Inlet pressure of 150 psi (10 bar) non-aspirated  
190 psi (13 bar) aspirated
- MAX inlet psi 250 psi (17 bar)
- Horizontal rotation up to 355°
- Vertical travel from +70° & -30°
- Inlet: 4" (100 mm) 150 lb flange (68 kg)
- Outlet: 3.5" NH (89mm)
- Proportional speed control
- One touch stow and deploy
- Obstacle avoidance
- Adjustable automatic oscillation
- Position feedback
- 12V or 24V (Must specify)
- Manual handwheel controls
- Works with Electric MasterStream Nozzles (standard outlet)
- Painted black finish
- Durable lightweight Pyrolite® construction
- UII Control System

#### Optional Features:

- Integrated dual gallonage foam tubes & fog nozzles
- Cowling with lights
- Wireless remote control
- Dry chemical piggy back nozzle
- Inside the cab manual overrides
- Rear inlet (4" flange, 4"- 5" victaulic)
- Custom paint (red, white, lime yellow, black standard)



Style 3356  
Trident Standard 3 1/2" Outlet  
Shown with Style 5178  
Akromatic™ 2000 Nozzle



Style 3356  
Trident Shown with  
Optional Integrated Dual  
Gallonage Fog Nozzle

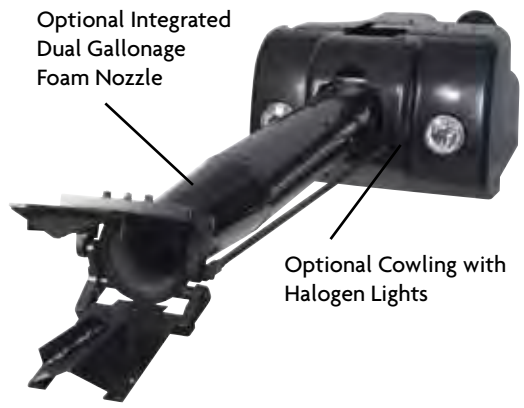

Optional Integrated  
Dual Gallonage  
Foam Nozzle

Optional Cowling with  
Halogen Lights

#### Dual flow selection gpm (lpm)

Low	375 (1500)	500 (1900)	600 (2250)	660 (2500)	750 (3000)	1000 (3800)
High	750 (3000)	1000 (3800)	1200 (4500)	1320 (5000)	1500 (6000)	2000 (7600)

## Electric Roof Turret

### 3353 Electric Roof Turret

- Flows from 250 to 1000 gpm (950 to 3800 lpm)
- 180° rotation & elevation travel
- 12 or 24 volt (Must Specify)
- 4" (100 mm) flange
- 2.5" (65 mm) outlet
- Position feedback
- Durable lightweight Pyrolite® construction
- Weight: 50 lbs (22.5 kg)
- Automatic drain valve for freeze protection
- Cast-in turning vanes for efficient flows
- Joystick or switch controller available



STYLE 3354  
Shown with Style 5177 Nozzle



STYLE 3353  
Shown with Style 5177 Nozzle

## FireFox™ Electric Remote Controlled Bumper Turret

The FireFox, an all Electronic Monitor from Akron Brass, is a technologically advanced remote controlled single waterway monitor. The FireFox Monitor is designed to meet various water, foam, CAFS, and dry chemical needs. This versatile 500 GPM (1900 LPM) monitor can be used for ARFF vehicles and deicing applications.

### 3463 FireFox Remote Controlled Monitor

For more product information see page 41



Position indicator available



Style 3600 Wireless Remote



Style 3463 Shown with Style 3293 Mid Flow Flat Disperse Nozzle

## TuckAway™ Electric Bumper Turret

### 3352 Electric Bumper Turret

- Flows from 250 to 1000 gpm (946 to 3800 lpm)
- Cast-in turning vanes for efficient flows
- Position feedback
- Durable, lightweight Pyrolite® construction

#### Options

- Accepts a large variety of nozzles
- Speed control
- Position indicator

Position indicator available



Style 3600 Wireless Remote



Style 3352 Shown with Style 5177 Akromatic

Style	Weight lbs. (kg)	Height	Width	Inlet	Outlet	Flow	
						GPM	LPM
3352	37 (16.8 kg)	13 1/2" (343 mm)	11 1/4" (285 mm)	3" FL (75 mm)	2 1/2" (65 mm)	1000	3800

See Page 50 & 51 for Electric Monitor Accessories

## Ultra High Pressure 300 GPM (1140 LPM)

Akron Brass continues to lead in the forefront of firefighting technology with the introduction of the Ultra High Pressure line of products. This line of product is designed to operate at pressures up to 1500 psi and deliver ultra-fine water droplets at high velocity for increased heat absorption and rapid fire extinguishment. This technology enhances your firefighting capabilities by rapidly reducing the temperatures within an enclosed area, increases your positive pressure ventilation capacity, and dramatically reduces personnel fatigue while using two-thirds less water.

### 3450 Ultra High Pressure Bumper Monitor

In the new arena of ultra high pressure fire fighting, Akron Brass is introducing its Ultra High Pressure Bumper Monitor. This Monitor is capable of delivering up to 300 GPM at 1500 psi.

- Durable stainless steel & brass construction
- Flows up to 300 GPM at pressures up to 1500 psi
- Vertical Travel: +70° & -30°
- Horizontal Travel: 180°
- 12V & 24V (Must Specify)
- Position Feedback (Rotation only)
- Uses Universal II Monitor Control System, See page 50 & 51



Style 3450  
Shown with  
Style 3292 Nozzle

#### Nozzle Options:



Style 3292 Ultra High Pressure Nozzle Available for 60 gpm @ 1100 psi or 300 gpm @ 1250 psi



Style 1417 Plain Tip w/ Style 3485 1 1/2" Mini Shaper



Style 3600  
Wireless Remote

Style	Weight lbs. (kg)	Height	Width	Inlet	Depth	Outlet	Flow	
							GPM	LPM
3450	61** (28 kg)	11 5/32"* (287 mm)	14 5/8"*** (372 mm)	2" NPT (50 mm)	13 5/32" (335 mm)	1 1/2" (38 mm)	300	1140

\* From bottom of elevation motor to top of elevation gearbox

\*\* Not including nozzle





## Heavy Duty Brass Swing-Out™ Valves

Akron Brass offers a wide variety of apparatus valves to meet the demands of today's fire service. All Swing-Out Valves are designed for operating pressures of at least 250 psi (17 bar) and meet the NFPA 1901 Standard for valve opening and closing speed control when operated with a gear actuator, electric actuator or Slo-Cloz™. In addition, every valve is factory tested in accordance with current NFPA Standards.



- A single valve body that will accept a variety of actuators.
- HydroMax™ technology: A ball geometry providing superior gating performance and flow characteristics
- No lubrication or regular maintenance required
- Simple two seated design (no O-Rings to cut or lose during assembly or maintenance)
- Wide range of available adapters
- High quality brass body cast, machined and assembled at our facility in Wooster, Ohio
- Available in 1"- 4" sizes
- See Valve Guide on pages 158 - 167 for more details

## 1" and 1.5" Swing-Out Valves





Commonly used on smaller trucks and lower flow applications, the 1" and 1.5" Swing-Out valves are available with a wide range of adapters and are simple to install and maintain throughout the life of the apparatus.

	Style	Size	Ball Type	Operating Pressure (psi)	Hydrostatic Pressure (psi)
	8810	1"	Stainless Steel	500	1000
	8910	1"	Polymer	500	1000
	8815	1.5"	Stainless Steel	250	500
	8915	1.5"	Polymer	250	500



Style 8815 with TS Handle

### Actuator Options

	Actuator Type	Available Lengths*	Available Accessories
	R1	3 1/2", 1 or 2 holes	
	TS	5" or 8"	-
	TSC	5" or 8"	-

\*See valve guide in technical data section for more details



Style 8810 with R1 Handle

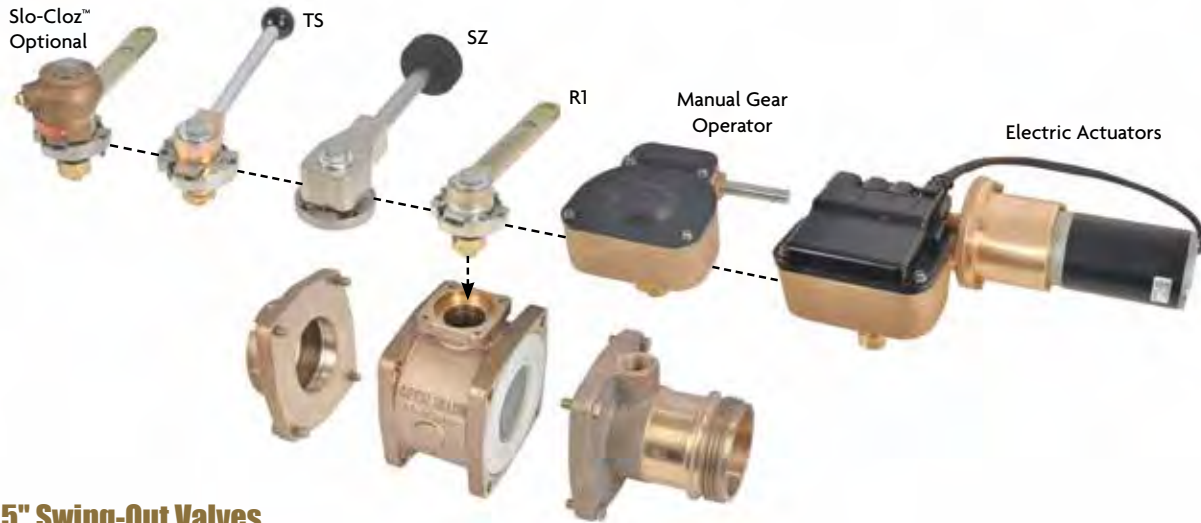

## 2" - 3.5" Swing-Out Valves

The 2" and larger Swing-Out valves are commonly used across all types of fire apparatus. With the broadest selection of adapters and options for actuation they have everything you need for your apparatus water flow control.

	Style	Size	Ball Type	Operating Pressure (psi)	Hydrostatic Pressure (psi)
	8620/8820*	2"	Stainless Steel	250	500
	8920	2"	Polymer	250	500
	8625/8825*	2.5"	Stainless Steel	250	500
	8925	2.5"	Polymer	250	500
	8630/8830*	3"	Stainless Steel	250	500
	8930	3"	Polymer	250	500
	8635/8835*#	3"	Stainless Steel	250	500
	8935#	3"	Polymer	250	500

High Performance Polymer Ball with HydroMax



Stainless Steel Ball with HydroMax



\* 8600 series valves for use with Gear, Electric and Air Actuators  
# 3.5" valves use the same body and ball as the 3" valves but include 3.5" adapters

### Actuator Options

	Actuator Type	Available Lengths*	Available Accessories	Compatible Style Numbers
	R1	3.5", 4.5", 6.75"; 1, 2 or 3 hole**		8800, 8900
	TS	5", 7", 9 1/4", 11"		8800, 8900
	TSC	5", 7", 9 1/4", 11"	-	8800, 8900
	Rack and Sector †	-		8600, 8900
	SZ	7", 9.25", 10.75"		8600, 8900***
	Gear	-		8600, 8900
	Electric	-		8600, 8900

\*See valve guide in technical data section for more details

\*\*4.5" 3 hole handle standard for 2" valves, 6.75" 2 hole handle standard for 2.5" - 3.5" valves

\*\*\*Available on 2.5" - 3.5" valves only

† Rack and sector body is unique to rack and sector assembly and not interchangeable and other actuators

## 4" Swing-Out Valves

### 8840 Heavy Duty 4" Swing-Out Valve With Flat Ball Design

- Designed for tank to pump use, deck gun or other higher flow applications
- Flat ball concept has spherical seating surface that easily closes and seals on the seat
- Use with air, gear or electric actuators
- Short 4" long body length. Can be used on side discharge applications and in restricted pump compartment space
- Easy-to-operate sealing system requires less torque to open and close the valve
- Reduced gear ratios:
  - Electric: 25:1 ratio - 8 seconds full open to close
  - Handwheel 50:1 ratio - 12 1/2 turns
- Weight: 36 lbs. (16.3 kg) (with electric actuator, less adapters)
- Wide range of available adapters (See pages 158-167)



Style 8840 with Electric Actuator



Style 8840 with Air Actuator

### 8940 4" Swing-Out Valve

- Designed for tank to pump use, deck gun or other higher flow applications
- Air, gear or electric actuation only
- High performance full flow polymer ball
- Number of turns for full open/close of gear actuator: 16



Style 8940 with Gear Actuator



Style 8940 High Performance Polymer Ball





## Manual Actuators

- R-1** Handle for remote valve operation of 8800 Series Swing-Out Valves
- TS** Handle for direct valve operation through the panel operation of 8800 Series Swing-Out Valves
- TSC** Handle with cover for exterior mounted 8800 Series Swing-Out Valves  
Same as the TS handle, with cover
- SZ** Handle with Twist Lock for direct valve operation through the panel of 8625-8635 Swing-Out Valves



## Electric Actuators

Akron's electric actuator is equipped with a magnet in the trunion to provide true position feedback. The motor, pressure, and flow sensor connections are all located right on the valve for shorter wire runs and simple installation. The electronics are fully sealed and utilize deutsch connectors for long life and reliability.

- Speed of valve opening and closing is preset to comply with the current NFPA 1901 Standard
- Operates on 12 or 24V apparatus electrical systems - Must specify
- Gear drive ratio:
  - 2" - 3 1/2" Swing-Out™ Valves - 16:1
  - Style 8840 - 25:1
  - Style 8940 and Butterfly Valves (4" - 8") - 64:1
  - Works with Weco, Keystone and Jamesbury Butterfly Valves
- Manual override

See page 159 for dimensions



Electric Actuator shown mounted on a Swing-Out Valve



8" Heavy Duty Electric Actuator

## Air Actuator

Air Actuators operate off the apparatus air supply and are equipped with an emergency override. Designed for full open/close applications only. Units are supplied with two air flow control valves to regulate the opening and closing valve speed to comply with the current NFPA 1901 Standard.

- Operates from -40° F to 125° F and requires 100-120 psi air pressure
- Available on 4" Swing-Out and all Butterfly Valves
- Solenoid and switch not included



Air Actuator shown with factory supplied Air Control Valves

## Push/Pull Remote Controls

Push/Pull Remote Controls operate in-line valves from the pump panel. Remote Controls can be used with Swing-Out™ Valves through 3 1/2" with R-1 Handles and are lockable in any position. The remote controls are furnished with an escutcheon plate, male or female swivel joint and stainless steel spring locks.

- Two stroke lengths available:
  - 8 1/4" for 1", 1 1/2", and 2" valves
  - 11 1/4" for 2 1/2", 3, and 3 1/2" valves
- Optional ball joint assembly
- Weight: 2 lbs. (.9 kg)



**1477 Push/Pull Remote Control with Recessed T-Handle**

**1478 Push/Pull Remote Control with Plain T-Handle**

## Slo-Cloz™

The Slo-Cloz reduces the chances of ruptured water lines, burst hose, or damaged seats and gaskets by controlling the opening and closing speed of the valve. The unit fits Tork-Lok® and current 2" - 3 1/2" locking and non-locking valves as well as valves with a Rack and Sector Actuator. Meets NFPA 1901.

- 7675 Slo-Cloz**
- Use with 8620-8635 non-locking valves
  - 2 1/2" - 3 1/2" valves with a Rack & Sector Actuator

- 7875 Slo-Cloz**
- Use with 8820-8835 Tork-Lok and self locking valves



## Rack And Sector Actuator

Minimizes troublesome linkage problems associated with remote handles. The Rack and Sector Actuator is usable with most pumps (depending on pump panel width). Available on 2 1/2" - 3 1/2" valves.

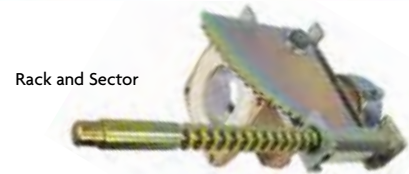

## Top-Mount Remote Control Actuator

Designed for operating valves from top-mounted operators panel.

- 101 Top-Mount Remote Control**
- 102**
- Control handle positioned 90° from remote handle
  - Additional pre-drilled hole for setting control handle at 135°
  - Heavy-duty all brass brake band
  - Cast brass construction with stainless steel handle rod
  - Remote Handle Lengths- 3 1/2" (Style 101) & 5" (Style 102)



## Handwheel Actuators

Handwheel Actuators are used for smooth, precise operation of valves such as on a deck gun, large diameter side discharge or ladder pipe.

- Handwheel driven worm gear rotates a gear sector for smooth and easy operation under pressure
- 2" - 3 1/2" valves have a 50:1 ratio and a 4" handwheel
- 8840 valves have a 50:1 ratio and a 6" handwheel
- Number of turns for full open/close:
  - 2" - 3 1/2" Swing-Out™ valves - 12 1/2 turns
- Opening and closing speed complies with the current NFPA standard to minimize effects of water hammer
- Helps prevent valve drift and accidental slamming open or closed
- Position Indicators for gear operated valve
- Optional Position Indicators show the valve position to meet NFPA 1901
  - Must specify landscape (side mount) or portrait (top mount)
  - Size: 3 1/2" x 5 3/4"
- Auxiliary Position Indicator - optional



# Swing-Out™ Valve Accessories & Pyrolite Swing-Out Valve

## Navigator™ Pro Valve Controller

The Valve Controller from Akron Brass provides reliable and accurate valve control with valve position indication. It is packed with user friendly features that improve operation effectiveness and safety.

### 9323 Electric Valve Controller

- Valve open and close.
- Full color LCD display visible in bright sunlight.
- True position feedback from the valve.
- User programmable presets.
- Valve name and the discharge color can be programmed on the top bar of the display.
- USB port on-board. Software for display and motor driver can be easily updated via USB flash drive.
- Easy to navigate setup menu.
- Auto dimming capability.
- Multiple display capable. Multiple displays can be used to control the same valve.
- Auto open. When option is turned on and valve is closed, pressing the open button once will automatically open the valve all the way.
- J1939 CAN networked.
- For use only with Navigator Pro Electric Actuator. See page 80 & 81 for Actuator details.



STYLE 9323 Navigator Pro Shown in Closed Position

### 9325 Navigator Pro Controller

All the same features as the 9323, plus the following:

- Optional pressure display. Can be displayed in psi, kPa or bar\*.
- Optional flow display. Can be displayed in gpm or lpm\*.
- Optional CAFS integration: turn CAFS on and off\*.
- Make sure even the most turbulent of flows is accurate with available custom calibration. Now easier than ever to custom calibrate the flow sensor through an easy to navigate menu.
- Totalizer function. Controller will calculate the volume of water flowed, through the paired valve. Resets every time the power is cycled to the valve. When networked with other 9325 controllers, total flow across all valves is shown.

\* Available when flow, pressure or CAFS equipment installed.



Style 9325 Navigator Pro with Pressure and Flow



Optional color indicators available in standard NFPA 1901 specified colors. Available on Styles 9323 and 9325.

## Lightweight Pyrolite Apparatus Swing-Out Valve

### 7725 2 1/2" Lightweight Apparatus Swing-Out Valve

- Ideal for use on aerial platforms
- Durable lightweight Pyrolite® construction
- Full flow 2 1/2" waterway
- Simple two seated design (no O-Rings to cut or lose during assembly or maintenance)
- No lubrication or regular maintenance required
- Designed & tested to exceed NFPA requirements
- Weight 9 3/8 lbs. (4.1 kg)

#### Adapter Options:

- MES1-S 90° Elbow
- PI-S Female NPT
- M1-S Male
- F1-S Female Swivel
- F1-SS Female Swivel with Strainer



Style 7725



## Revolution® Intake Valve

Featuring a unique patent-pending handwheel, the Revolution provides the operator more control and leverage for a smooth and easy operation. This revolutionary valve is constructed of corrosion-resistant, hard-anodized aluminum and stainless steel for superior corrosion protection.

### Compact Design

Its compact design saves valuable space on your pump panel. The revolutionary handwheel design hugs tightly to the valve body eliminating possible interference with surrounding discharges and equipment on the pump panel.

### Revolutionary Features

The Revolution has all of the standard features you would expect from an intake valve with flows capable up to 2000 gpm (7600 lpm) making it ideal for the most demanding apparatus intake applications.

- Field serviceable design
- NFPA 1901 compliant
- 10 year heavy duty warranty\*

- 7982** Revolution Intake Valve with Swiveling Elbow
- 7983** Revolution Intake Valve without Swiveling Elbow

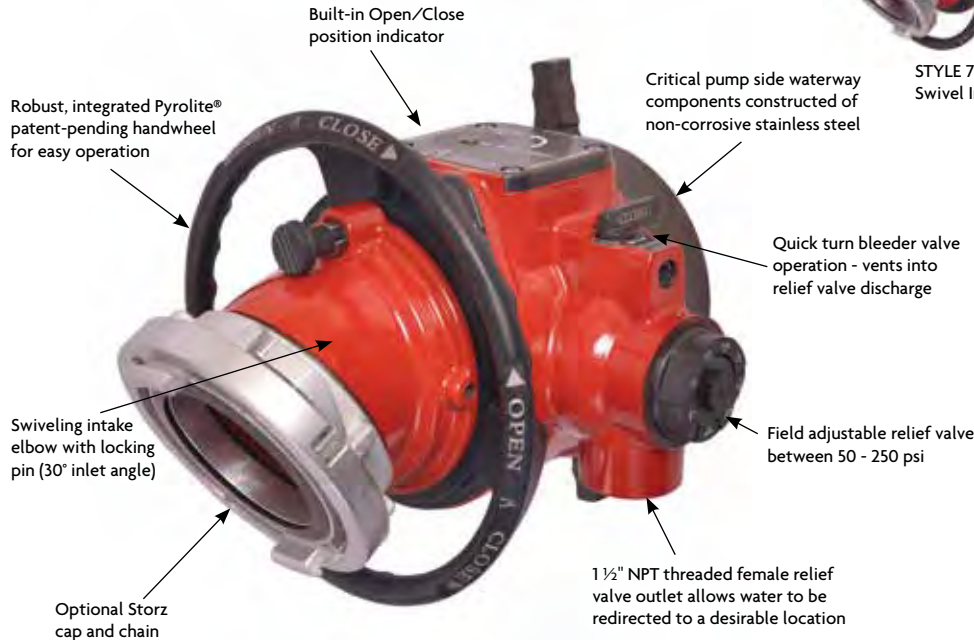

STYLE 7982 Swivel Inlet



STYLE 7983 Straight Inlet



\*Limited to Manufacturer Defect and Corrosion

Style	Inlet Options	Outlet	Height	Depth	Width	Weight	Max Operating Pressure	Maximum Flow	Friction Loss (@ 2000 GPM)
7982	4", 5" or 6" (100, 125 or 150 mm) Storz** 4" or 5" (100 or 125) Full Time Storz Swivel 4", 4 1/2", 5" or 6" (100, 110, 125 or 150 mm) Male 4", 4 1/2" or 5" (100, 110 or 125 mm) Female	5" or 6" (125 or 150 mm) Rocker Lug or Long Handle***	12.3" (312 mm)	14.9" (378 mm)	14.25" (362 mm)	40 lbs. (18.2 kg)	250 psi (17 bar)	2000 GPM (7600 LPM)	7 PSI (.5 bar)
7983	4", 5" or 6" (100, 125 or 150 mm) Storz** 4" or 5" (100 or 125) Full Time Storz Swivel 4", 4 1/2", 5" or 6" (100, 110, 125 or 150 mm) Male 4", 4 1/2" or 5" (100, 110 or 125 mm) Female	5" or 6" (125 or 150 mm) Rocker Lug or Long Handle***	12.3" (312 mm)	11.75" (300 mm)	14.25" (362 mm)	38lbs. (17.2 kg)	250 psi (17 bar)	2000 GPM (7600 LPM)	7 PSI (.5 bar)

\* Refer to the full warranty statement for complete details, Limited to manufacture defects and corrosion.

\*\* Cap and chain optional

\*\*\* 6" only

## Black Max Piston Intake Valve

### 7980 Black Max Piston Intake Valve

Corrosion resistant stainless steel and poly-impregnated aluminum are combined for a durable Piston Intake Valve. A large unique oval waterway increases efficiency while reducing the overall size. All this, plus a special 10 year warranty against corrosion makes the Black Max the obvious choice for today's fire service.

#### Standard Features:

- Stainless steel piston housing
- Compact size - Extends only 11 15/16" from the pump panel
- 250 psi operating pressure
- Polymer Piston for improved corrosion resistance
- Large waterway with a cast-in turning vane for reduced turbulence and efficient flow
- Pressure relief valve adjustable from 50 - 250 psi (factory preset @ 150 psi)
- 53° elbow
- 3/4" air bleeder valve

#### Optional Features:

- Storz cap and chain
- Air bleeder lines



\*Limited to Manufacturer Defect and Corrosion

Style 7980

Style	Female Swivel Inlet	Outlet	Height	Depth	Width	Weight
7980	4", 5" or 6" (100, 125 or 150 mm) Storz* 4" or 5" (100 or 125) Full Time Storz Swivel 4", 4 1/2", 5" or 6" (100, 110, 125 or 150 mm) Male 4", 4 1/2" or 5" (100, 110 or 125 mm) Female	5" or 6" (125 or 150 mm) Rocker Lug or Long Handle**	18 7/8" (479.4 mm)	11 15/16" (303.2 mm)	9 9/16" (242.8 mm)	30 lbs. (13.6 kg)

\* Cap and chain optional

\*\* 6" only

## Butterfly Valves

Available in 4", 4 1/2", 5", and 6" full flow sizes. Meets NFPA 1901 Standard for opening and closing speed when used with Gear\*, Air or Electric Actuators. Manual quarter-turn handle is available for dump valve applications. Body and adapters are lightweight pyrolite construction. Optional drain valve available.

#### Optional Inlets & Outlets:

- Male
- Female NPT
- Female Swivel (Rocker lug or long handle)
- Victaulic
- Storz (Swivel standard on 4" & 5", 6" rigid only)



Style 7960  
with Gear Actuator

Style	Size	Length	Weight lbs. (kg)**	Operating Pressure (PSI)
7940	4" (101 mm)	9 1/2" (241 mm)	21 1/4 (9.6 kg)	250
7945	4 1/2" * (114 mm)	9 3/4" (248 mm)	27 1/4 (12.7 kg)	250
7950	5" (125 mm)	10" (254 mm)	28 1/2 (12.9 kg)	250
7960	6" (152 mm)	10" (254 mm)	35 1/2 (16.1 kg)	250

\* Not compatible with position indicator

\*\* Body weights and lengths with rocker lug female x male with handwheel actuator



## Intake Pressure Relief Valve

### 53 Intake Pressure Relief Valve

For mounting on main pump intakes with a four bolt flange. Field adjustable pressure setting.



Style 53

Style	Outlet	Inlet Flange	Pressure Range*	Weight
53	2.5" NPT 2.5" NH 2.5" VIC	4 3/8" 4 19/32"	50 - 175 PSI	14 3/8 lbs (6.5 kg)

\* Factory set at 125 PSI

## Drain Valves

### 57 Quarter Turn Drain Valve

- T-handle extends 2" from the panel for easy turning
- Available in 0° or 90° handle position - Must specify
- For hydrostatic pressures up to 500 psi
- 3/4" NPT threads
- Weight: 1 1/2 lbs. (.68 kg)



Style 57  
Shown with large  
recess handle

### 4 Drain Drain Valve

- Small, compact drain valve
- 3/4" NPT male thread
- Opening equivalent to 3/8" diameter hole
- Length: 2 1/4"
- Weight: 10 oz. (.28 kg)



Style 4

### 7 3/4" Drain Valve

- Push-pull valve for draining discharge, suction, or in-line valves
- For hydrostatic pressures up to 500 psi
- Brass handle shaft and body
- 3/4" NPT female inlet and outlet thread
- Weight: 1 1/4 lbs. (.57 kg)

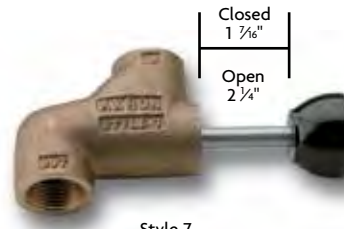

Style 7

Closed  
1 7/16"

Open  
2 1/4"







### Gate Valves

A heavy-duty wedge seat gate valve with a non-rising stem and crank handle for easy operation at standard operating pressures.

- 285**     **2 1/2" Gate Valve - Brass**
- 2285**    **2 1/2" Gate Valve - Pyrolite**
- 2286**    **3 1/2" Gate Valve - Pyrolite**
  - Less than 1 psi friction loss @ 1500 gpm



Style 285



Style 2285



Style 2286

Style	Material	Size	Length	Weight lbs. (kg)	Max Operating Pressure	Inlet	Outlet	Number Of Turns
285	Cast	2 1/2" (65 mm)	5 1/2" (140 mm)	13 (5.9 kg)	250 PSI (17 bar)	2 1/2" F (65 mm)	2 1/2" M (65 mm)	5
2285	Pyrolite	2 1/2" (65 mm)	5 1/2" (140 mm)	4 (1.8 kg)	250 PSI (17 bar)	2 1/2" (65 mm)	2 1/2" (65 mm)	21
2286	Pyrolite	3 1/2" (89 mm)	7 1/4" (184 mm)	10 (4.5 kg)	250 PSI (17 bar)	3" - 5" F (75 - 125 mm) 4" - 5" Storz (100 - 125 mm)	3" - 5" M (75 - 125 mm) 4" - 5" Storz (100 - 125 mm)	31

### Hydrant Valve

- 1828**    **2 1/2" Hydrant Valve**  
A full flow valve with a Tork-Lok® handle for more positive handle positioning.



Style 1828

Style	Material	Size	Length	Weight lbs. (kg)	Max Operating Pressure	Inlet	Outlet
1828	Pyrolite	2 1/2"	7 1/4" (184 mm)	7 1/2 (3.4 kg)	300 PSI (21 bar)	2 1/2" F (65 mm)	2 1/2" M (65 mm)

### Hydrant Valve

- 627**     **4-Way Hydrant Valve**  
This valve allows you to provide water to the fire at hydrant pressure, while waiting for a second pumper to hook up and increase flow and pressure.

- Flow efficient 3 1/2" waterway
- 75 psi maximum pressure differential during changeover
- 300 psi maximum operating pressure
- 1000 gpm maximum flow when changing the ball position
- Mounting bracket available

#### How It Works:

- Step 1 - Attach the 4-Way Hydrant Valve to the hydrant and forward lay to the engine at fire scene.
- Step 2 - Attach a hose from the 4-Way Hydrant Valve to the intake on the engine at the hydrant.
- Step 3 - Attach a hose from the discharge on the engine at hydrant to the 4-Way Hydrant Valve inlet. Establish recirculating flow at hydrant pressure.
- Step 4 - Rotate the handwheel on top of the 4 way Hydrant Valve to introduce pressurized flow from the engine at the hydrant to the engine at the fire scene. Increase pressure on the pumper to increase flow as required.

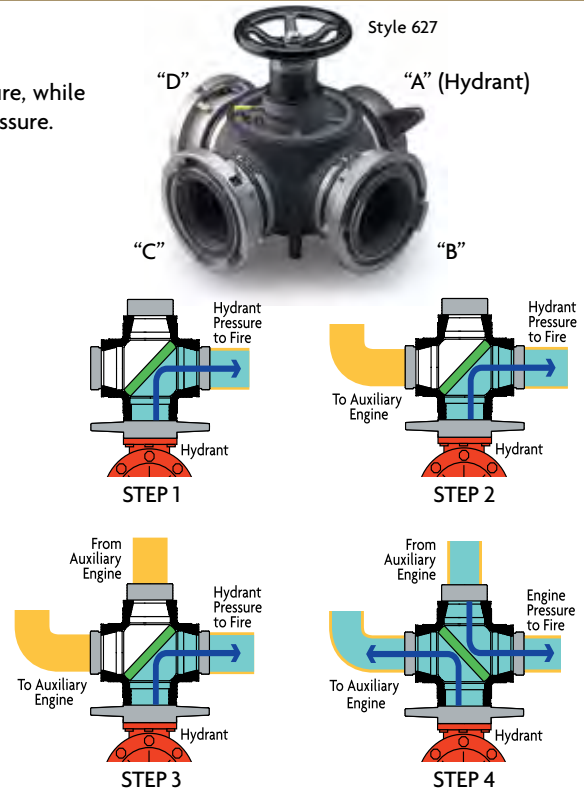

Style	Material	Length	Width	Weight lbs. (kg)	Inlet	Outlet	Flow		Connections			
							GPM	LPM	A	B	C	D
627	Pyrolite®	13 3/4" (349 mm)	13 3/4" (349 mm)	42 (19 kg)	(2) 2 1/2" - 5" F* (65 - 125 mm)	(2) 2 1/2" - 5" M (65 - 125 mm)	1500	3800	4" - 6 (100 - 150 mm) threads or Rigid Storz	2 1/2" - 6 (65-150 mm) threads or 4" - 5" Rigid Storz	2 1/2" - 6 (65-150 mm) threads or 4" - 5" Rigid Storz	2 1/2" - 6 (65-150 mm) threads or 4" - 5" Rigid Storz

\* Hydrant inlet 4" - 5" (100 - 125 mm) only

## Gated Wyes

- 1482 Hydrant Wye**
  - Self-locking Tork-Lok® handles for positive handle positioning
- 1581 Leader Line Wye**
  - Self-locking Tork-Lok® handles for positive handle positioning
- 1582 Hydrant Wye**
  - Self-locking Tork-Lok handles for positive handle positioning
- 2580 1 1/2" Wye**
  - High strength polymer handles
- 2581 Leader Line Wye**
  - High strength polymer handles
- 2582 3-Way Hydrant Wye**
  - Self-locking Tork-Lok handles for positive handle positioning
- 2681 Leader Line Wye**
  - Designed for heavy-duty use in severe environments.
  - High strength polymer handles & balls standard
  - Optional metal handles & balls



Style 1482



Style 1581



Style 1582



Style 2580



Style 2581



Style 2582



Style 2681

Style	Material	Length	Width	Weight lbs. (kg)	Inlet	Outlet
1482	Brass	8 1/4" (209 mm)	12" (305 mm)	31 1/4 * (14.2 kg)	2 1/2"- 6" F (65-150 mm)	(2) 2 1/2" M (65 mm)
1581	Pyrolite®	5 3/4 (146 mm)	6 3/4" (171 mm)	5 1/2 (2.5 kg)	2 1/2" F (65 mm)	(2) 1 1/2" M (38 mm)
1582	Pyrolite	9 1/2" (241 mm)	11" (279 mm)	16 3/4 * (7.6 kg)	2 1/2"- 6" F (65-150 mm) 4" or 5" Storz (100 or 125 mm)	(2) 2 1/2" M (65 mm)
2580	Pyrolite	5 1/2" (140 mm)	7" (178 mm)	3 (1.4 kg)	1 1/2" F (38 mm)	(2) 1 1/2" M (38 mm) or (2) 1" M (25 mm)
2581	Pyrolite	5 1/2" (140 mm)	7" (178 mm)	3 (1.4 kg)	2 1/2" F (65 mm)	(2) 1 1/2" M (38 mm)
2582	Pyrolite	11 3/4" (298 mm)	15 1/2" (394 mm)	24 1/2 * (11 kg)	2 1/2"- 6" F (65-150 mm) 4" or 5" Storz (100 or 125 mm)	(3) 2 1/2" M (65 mm)
2681	Brass	7 1/2" (19 cm)	5 1/4" (13.3 cm)	10 1/2 (3.4 kg)	2 1/2" F (65 mm)	(2) 1 1/2" M (38 mm)

\* Weight with 4 1/2" (11.4 cm) inlet

## Plain Wye

Style	Material	Length	Width	Weight lbs. (kg)	Inlet	Outlet
1260	Pyrolite	9 1/8" (232 mm)	8" (203 mm)	6 3/4 (3.1 kg)	2 1/2" F (65 mm)	2 1/2" M (65 mm)



Style 1260

## Water Thief

For extending 1 1/2" or 2 1/2" lines without interfering with the operation of other lines. Includes Self-locking Tork-Lok handles for more positive handle positioning.

Style	Material	Length	Width	Weight lbs. (kg)	Inlet	Outlet
1573	Pyrolite	9 3/8" (238 mm)	10 1/2" (267 mm)	12 (5.4 kg)	2 1/2" F (65 mm)	(2) 1 1/2" M & (1) 2 1/2" M (38 & 65 mm)



Style 1573

## Clappered Siamese

- 262 Clapper Valve Siamese**  
A brass Clapper Siamese with a leather carrying handle and 3/4" drain plug
- 1256 3-Way Clapper Valve Siamese - Pyrolite®**  
Three 2 1/2" female inlets x 4" to 6" male or female outlet. Includes Style 4 Drainit drain valve and rubber carrying handle
- 200 psi operating pressure
  - Optional Pressure Gauge
- 1262 Clapper Valve Siamese**  
A Pyrolite Clapper Siamese includes a Style 4 Drainit drain valve and a rubber carrying handle
- 1267 Clapper Valve Siamese**  
A Pyrolite Clapper Siamese includes a Style 4 Drainit drain valve and a rubber carrying handle



Style 262



Style 1256



Style 1262



Style 1267

Style	Material	Length	Width	Weight lbs. (kg)	Inlet	Outlet
262	Brass	7 3/4" (197 mm)	9" (229 mm)	14 1/2 (6.6 kg)	(2) 2 1/2" F (65 mm)	2 1/2" or 3" M (65 or 75 mm)
1256	Pyrolite	12 3/4" (323 mm)	14 3/4" (375 mm)	15 1/2 (7 kg)	(3) 2 1/2" F (65 mm)	2 1/2" - 6" M or F (65-150 mm)
1262	Pyrolite	8 1/2" (216 mm)	9 3/8" (238 mm)	7 1/4 (3.3 kg)	(2) 2 1/2" F (65 mm)	2 1/2" or 3" M (65 or 75 mm)
1267	Pyrolite	9 3/8" (238 mm)	9 3/8" (238 mm)	9 1/2 (4.3 kg)	(2) 2 1/2" F (65 mm)	2 1/2" - 6" F, (65-150 mm) 3 1/2" - 6" M, 4" or 5" Storz (89-150, 100 or 125 mm)

\* Weight with 4 1/2" (114 mm) outlet

## Gated Siamese

Siamese with quarter-turn valves provide a positive shutoff and easier operation. All 2 1/2" swivel inlets are supplied with strainers.

- 1583 Suction Siamese**  
Used on pumper suction or aerial platform inlets. Features Tork-Lok® handles for positive handle positioning.
- 2583 3-Way Suction Siamese**  
Used on pumper suction or aerial platform inlets. Features Tork-Lok handles for more positive handle positioning.



Style 1583



Style 2583

Style	Material	Length	Width	Weight lbs. (kg)	Inlet	Outlet
1583	Pyrolite®	9 1/4" (235 mm)	11 1/2" (292 mm)	16 * (7.3 kg)	(2) 2 1/2" F (65 mm)	2 1/2" - 6" F or M 4" or 5" Storz (65 - 150 or 100 or 125 mm)
2583	Pyrolite	11 3/4" (298 mm)	16" (298 mm)	26 1/2* (12 kg)	(3) 2 1/2" F (65 mm)	2 1/2" - 6" F or M 4" or 5" Storz (65 - 150 or 100 or 127 mm)

\* Weight with 4 1/2" (114 mm) inlet





Akron® Municipal Eductors feature a large, easy to read, and removable metering dial with settings between 0% and 6%. The Eductors are rated to flow at 200 psi (14 bar) inlet pressure and work well with nozzles rated at 75 and 100 psi (5 and 7 bar).

## In-Line Eductors

- 1 1/2" (38 mm) or 2 1/2" (65 mm) full-time swivel inlet x 1 1/2" (38 mm) male, except where noted
- 30" (762 mm) pickup hose standard on 60, 95 and 125 gpm (230, 360 and 475 lpm) eductors, 48" optional
- 48" (1220 mm) pickup hose standard on 250 gpm (950 lpm)



Style 3095

Style	Inlet Size	Outlet Size	Flow		Material	Length	Weight lbs. (kg)
			GPM	LPM			
3060	1 1/2" or 2 1/2" (38 or 65 mm)	1 1/2" (38 mm)	60	230	Pyrolite®	* 7 3/4" (197 mm)	3 1/2 (1.6 kg)
3071	1 1/2" (38 mm)	1 1/2" (38 mm)	95	360	Brass	7 3/4" (197 mm)	9 1/4 (4.2 kg)
3095	1 1/2" or 2 1/2" (38 or 65 mm)	1 1/2" (38 mm)	95	360	Pyrolite	* 7 3/4" (197 mm)	3 1/2 (1.6 kg)
3125	1 1/2" or 2 1/2" (38 or 65 mm)	1 1/2" (38 mm)	125	475	Pyrolite	* 7 3/4" (197 mm)	3 1/2 (1.6 kg)
3250	2 1/2" (65 mm)	2 1/2" (65 mm)	250	950	Pyrolite	12" (305 mm)	8 1/2 (3.7 kg)

\* 1 1/2" (38 mm) inlet length, 2 1/2" (65 mm) inlet length: 8 1/2" (216 mm)



3095 In-Line Eductor with Quick Connect On-Board Foam Access

## Portable Eductor with On-Board Foam Access

Included:

- Eductor with a special pickup assembly with a quick connect coupling
- Foam Access Panel Mount Kit
- Quarter Turn Valve with Tee Handle and Label



Quick Connect Panel Mount with Plug



Quarter Turn Valve

## Industrial/Marine In-Line Eductors

### 2328 90 gpm (340 lpm) Brass In-Line Eductor

- Set at 6% pickup rate, easily changed to 3%
- Includes foam shutoff valve and 60" pickup hose

### 2901 90 gpm (340 lpm) Brass In-Line Eductor

- Set at 6% pickup rate; easily changed to 3%
- 54" pickup hose

### 2325 95 gpm (360 lpm) Brass In-Line Eductor

In-Line Eductor designed for use at 125 psi (8.62 bar).  
(Note: Lower eductor inlet pressures reduce nozzle stream reach.)

- 1%, 2%, 3%, and 6% foam settings
- Removable foam pickup tube with metering dial for easy service and testing

### 2120 120 gpm (460 lpm) Brass In-Line Eductor

- Metering dial settings: 1/2%, 1%, 3%, 6%



Style 2328



Style 2325

Style	Length	Weight lbs. (kg)	Female Inlet	Male Outlet	Operating Pressure PSI (bar)	Flow	
						GPM	LPM
2120	12 7/8" (327 mm)	12 (5.4 kg)	2 1/2" (65 mm)	2 1/2" (65 mm)	200 (14)	120	460
2325	10 1/8" (257 mm)	7 (3.1 kg)	1 1/2" (38 mm)	1 1/2" (38 mm)	125 (8.62)	95	360
2328	9 1/2" (241 mm)	8 (3.6 kg)	1 1/2" (38 mm)	1 1/2" (38 mm)	200 (14)	90	340
2901	9 1/2" (241 mm)	8 (3.6 kg)	1 1/2" (38 mm)	1 1/2" (38 mm)	200 (14)	90	340



## Portable By-Pass Educators

The Akron By-Pass Educator has a built-in by-pass chamber, allowing the operator to change from water to foam without shutting down.

- 1 1/2" or 2 1/2" swivel inlet x 1 1/2" male
- Brass with chrome trim
- 8 quick-change handle positions with a Swing-Out™ Valve handle
- Optional pipe thread connections available for truck plumbing



Style 3097

Style	Inlet Size	Outlet Size	Flow		Material	Length	Weight lbs. (kg)
			GPM	LPM			
3097	1 1/2" or 2 1/2" (38 or 65 mm)	1 1/2" (38 mm)	95	360	Brass	18" (457 mm)	20 (9.1 kg)

## Foam Truck Systems

- 8 quick change handle positions (easily changed after installation) means less installation time
- Specify inlet and outlet, 2", 2 1/2" NPT or 2" victaulic
- Easily changed to water line use

Each Truck System Includes:

- Rugged brass by-pass educator
- Foam metering dial with six foam settings from 0% - 6%
- One 2" In-line Swing-Out™ valve - with built-in check valve
- Two 1" In-line Swing-Out valves
- One 1" check valve
- Four Style 1477 remote controls

Note: Each truck system is for a single tank operation. A two tank system requires one (1) additional 1" Swing-Out Valve, 1" check valve and 1477 Remote Control.

**3096 95 gpm (360 lpm) Foam Truck System**

**3126 125 gpm (475 lpm) Foam Truck System**



By-Pass Educator



Style 3096

Foam Metering Dial

**See Pages 178 & 179 For Foam System Plumbing**

## Off-Truck Foam Access Kit

A quick disconnect pickup tube for off-truck foam access can be easily added to an existing Akron® Foam System or can be included with any new system if specified.

Designed for:

- Switching between class A and B foams
- Supplementing a depleted foam supply

Each Kit Includes:

- Quick connect panel mount and plug
- One 1" check valve
- One 5' quick connect pickup hose assembly
- One Style 57 drain valve

**3128 Off-Truck Foam Access Kit**



Style 3128







### Application Chart

Eductor Connected to a Pumper Discharge - 200 psi (14 bar) Inlet Pressure

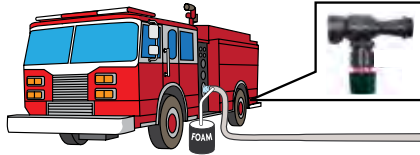

Eductor Connected at a Point Between the Pumper and the Foam Nozzle

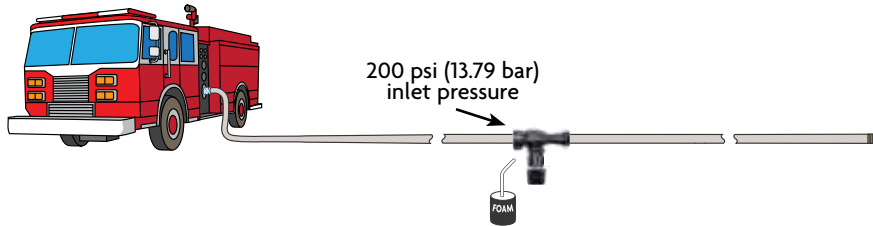

Foam Application without the use of an Eductor

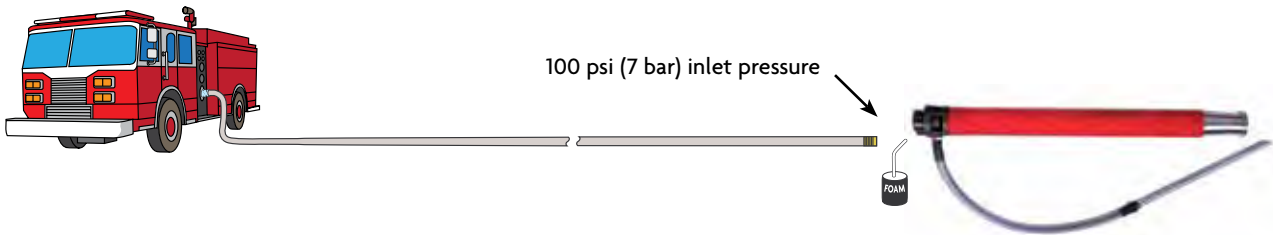

### General Instructions for Akron® Eductors

(Includes in-line, by-pass and built-in types of any flow size)

1. Hose lay limits past the eductor must not be exceeded. (see chart at right)
2. 200 psi (14 bar) must be maintained at the eductor inlet to obtain the proper mixture.
3. The nozzle and eductor must be rated at the same flow for maximum performance. However, in all cases, the nozzle flow setting must not be less than the eductor.
4. The nozzle must be fully open. A throttled nozzle can cause the system to shut down.
5. Always flush both the eductor and nozzle thoroughly, for at least 3 minutes, after each use.

#### \*Hose Lay Limit

GPM (LPM)	Hose Size							
	Up To 1% (Class A)				3% - 6% Class B			
	1 1/2" (38 mm)	1 3/4" (45 mm)	2" (50 mm)	2 1/2" (65 mm)	1 1/2" (38 mm)	1 3/4" (45 mm)	2" (50 mm)	2 1/2" (65 mm)
60 (227)	600' (182.9 m)	900' (274.3 m)	-	-	400' (121.9 m)	600' (182.9 m)	-	-
95 (359.5)	200' (61 m)	350' (106.7 m)	-	-	150' (45.7 m)	250' (76.2 m)	-	-
125 (473)	-	200' (61 m)	400' (121.9 m)	-	-	150' (45.7 m)	300' (91.5 m)	-
250 (946)	-	-	-	350' (106.7 m)	-	-	-	300' (91.5 m)

\* All hose lays based on no elevation, measured from the discharge side of the eductor with 200 psi inlet pressure and with a 100 psi rated nozzle. If a 75 psi rated nozzle is used hose lengths may be extended.

#### Notes About Various Operating Pressures

Akron eductors are designed to work at 200 psi (14 bar) inlet pressure for maximum effectiveness. At 200 psi (14 bar), the mixture percentage will be as shown on the metering dial. Akron eductors can educt foam concentrate at pressures between 50 (3.5 bar) and 200 psi (14 bar). At lower pressures the flow of water will be less, but the flow of foam concentrate will remain the same. This means the percentage of concentrate will be higher than shown on the metering dial. Since the flow out of the eductor will be reduced at lower inlet pressures, the nozzle pressure will be lower. This may significantly reduce reach.

## Hand Held Pitot

### HHPT

- Heavy duty aluminum blade and stainless steel pitot tube
- Pitot blade has numbered increments for increased accuracy
- Conveniently located bleeder valve
- 3 1/2" (89 mm) liquid filled 0-160 psi (0-1100 kPa) gauge
- Heavy-duty carrying case



HHPT

## Apparatus Flow Test Kits

### AFTK-SK (Low Flow)

- Standard with 3/4", 1", 1 1/4", 1 1/2", 1 3/4" (19, 25, 32, 38, 44 mm) tips
- 3 1/2" (89 mm) liquid filled 0-160 psi (0-1100 kPa) gauge
- Large, heavy duty carrying case (FK-230), 18 3/8" W x 14 1/4" D x 8" H
- 2 1/2" NH (65 mm) female swivel - Standard
- Certified calibrated gauges
- Flow range: 25-700 gpm (95-2650 lpm)



AFTK



### AFTK-LK (High Flow)

- Standard with 1 1/2", 1 3/4", 2", 2 1/4" & 2 1/2" (38, 44, 50, 57 & 65 mm) tips
- 3 1/2" (89 mm) liquid filled 0-160 psi (0-1100 kPa) gauge
- Large, heavy duty carrying case (FK-230), 18 3/8" W x 14 1/4" D x 8" H
- 2 1/2" NH (65 mm) female swivel - Standard
- Certified calibrated gauges
- Flow range: 25-1900 gpm (95-7200 lpm)

## Hydrant Flow Test Kit

### AHTK-25

- Includes a 2 1/2" (65 mm) barrel with a pitot tube positioned in the waterway and water diffuser assembly
- 3 1/2" (89 mm) liquid filled 0-160 psi (0-1100 kPa) gauge
- Supplied with flow charts for accurate measuring
- Pitot tube is positioned for accurate readings
- 2 1/2" NH (65 mm) female swivel
- Ideal for flows between 608-1851 gpm @ 10-140 psi range
- Heavy duty, black case (FK-230) 18 3/8" (L) x 14 1/4" (W) x 8" (H) (466.7 mm (L) x 361.95 mm (W) x 203.2 mm (H))



AHTK-25

## Large Diameter Kits

### AHTK-45

- Includes a 4 1/2" (110 mm) barrel with a pitot tube positioned in the waterway, and water diffuser assembly
- 3 1/2" (89 mm) liquid filled 0-160 psi (0-1100 kPa) gauge
- Supplied with flow charts for accurate measuring
- Pitot tube is positioned for accurate readings
- Heavy-duty extra large case available

AHTK-45



P/N	Size	Flows	
		Low	High
AHTK-45	4.5" (110 mm)	879 gpm (3327 lpm)	6214 gpm (23523 lpm)



### Portable Flow Meter

#### 9301 Portable Flow Meter

- A technologically advanced flow and pressure meter with stainless steel paddle wheel
- Solid state electronics with no moving parts to adjust
- Includes a heavy-duty storage case, 12V internal battery, 110V AC battery charger, 12V DC auto power supply cord
- 2 1/2" (65 mm) female swivel
- Maximum flow 1250 gpm (4800 lpm) through 2 1/2" (65 mm) sensor body
- Width: 20 1/2" (520.7 mm), height: 17 1/2" (444.5 mm), depth: 8 1/2" (215.9 mm)
- Weight: 30 lbs (13.6 kg)
- See page 185 Technical Data section for more details regarding flow meter set up



Style 9301

### Hose Test Valve

#### 2285 Hose Tester Gate Valve

Meets NFPA 1962 requirements for testing hose with fire apparatus. Includes 1/4" hole in gate for maintaining test pressure at low volume.

Style	Material	Size	Length	Weight lbs. (kg)	Inlet	Outlet	Number Of Turns
2285	Pyrolite®	2 1/2" (65 mm)	5 1/2" (140 mm)	4 (1.8 kg)	2 1/2" (65 mm)	2 1/2" (65 mm)	21



Style 2285  
Hose Gate Valve

### Apparatus Test Gauge Kit

#### ATGK-3

- Same as ATGK-2 with a space for an extra gauge to be mounted



ATGK-3

### Pressure/Vacuum Panel Adapter

#### 44 Pressure/Vacuum Panel Adapter

- Complete fitting for pump panel
- Simplifies attachment of gauges for pump tests
- Remove hex plugs and screw in gauges
- Length: 3 1/2" (89 mm), height: 1 3/8" (35 mm), weight: 8 oz.



Style 44



## Cap Gauge

- Certified calibrated gauges
- Designed for determining the static pressure of water in fire hydrants, fire hoses, and/or fire pumps
- 3 1/2" liquid filled 0-160 psi (0-1100 kpa) gauge, 2 psi (20 kPa) increments, ±1% accurate full scale
- Pyrolite construction

Style	Description
HCGK-25	2 1/2" (65 mm) NH Cap Gauge



HCGK-25

## Line Gauges

### HLGK Line Gauge

- Designed to determine nozzle pressure and static pressure
- 3 1/2" (89 mm) freeze protected liquid filled 0-160 psi (0-1100 kpa)
- NH threads only

Style	Description
HLGK-15	1 1/2" (38 mm) Line Gauge
HLGK-25	2 1/2" (65 mm) Line Gauge



Style 35

HLGK-25

### 35 Line Gauge

- Ideal for use in high-rise packs
- Available in 2 1/2" and 3" sizes
- 1 1/2" diameter gauge (0-300 psi) with guard
- Grade B 3%-2%-3% accuracy
- Inlet: 2 1/2" (65 mm), weight: 2 lbs (.907 kg), length: 5" (127 mm)
- Inlet: 3" (75 mm), weight: 2 1/2 lbs (1.13 kg), length: 5 1/2" (139.7 mm)
- Certified calibrated gauges
- Pyrolite® construction





## Manual Calculator

- 9100 Fire Stream/Friction Loss Calculator**  
Shows nozzle pressure calculations on one side and friction loss on the other side.



Style 9100

## FireCalc™ Pocket Calculator

The FireCalc Pocket Calculator is the training tool every fire fighter needs. The Akron® FireCalc is the only calculator on the market to offer solutions for engine pressure, friction loss, application rate, flow rate, reaction force...etc. Don't guess on important numbers - use the FireCalc!

- 9900 FireCalc Pocket Calculator**
- English and metric capability
  - Review feature
  - Auto power off
  - 5 1/2" (139.7 mm) x 2 7/8" (73 mm)



Style 9900



## V-MUX ELECTRICAL SYSTEM SOLUTION = HARDWARE, SOFTWARE, AND SUPPORT

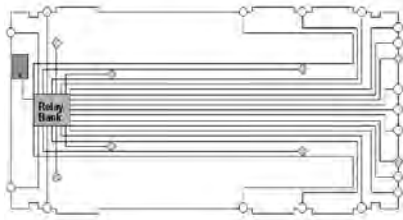

Traditional Wiring

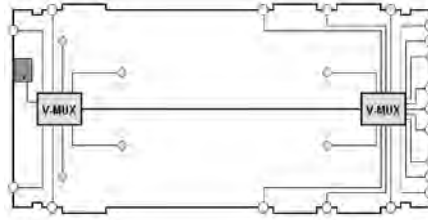

V-MUX Wiring

Multiplexing is a means of transmitting multiple signals over one line.

### V-MUX ADVANTAGE

**Fewer wires.** Traditional electrical systems have hundreds of wires running along the frame and through the cab and body. This often makes it difficult to install new components or troubleshoot existing ones. V-MUX will reduce the number of wires, reducing your labor.

**Fewer splices and connectors.** Fewer wires also means fewer splices and connections. Poor splicing techniques and corroded connections are two of the most common problems with traditional vehicle wiring. V-Mux reduces splices by 75% and reduces connections by 25%.

**No electromechanical relays.** Traditional wiring systems need to use relays for logic and output control. Relays are mechanical devices that will eventually fail. V-MUX uses solid state devices that do not wear out.

**Built-in diagnostics.** The laborious job of tracing electrical faults with a trouble light and volt-ohm meter is simplified by the built-in diagnostics that can be incorporated into the displays with a V-MUX System.

**Dedicated factory support.** The V-MUX system is supported by a world-wide, highly trained and specialized engineering group.

**An Enabling Technology.** V-MUX allows the OEM to add more features and respond to market demands more quickly.

V-MUX integrates all systems and components; empowering the OEM to design their electrical systems using an intuitive suite of software tools.



### V-MUX® MULTIPLEXING SYSTEM

V-MUX is a complete electrical control system. The power distribution units (nodes) reduce wire harness bundles and electrical control hardware. Our software introduces advanced control features not available in traditional wiring systems. The combination of hardware and software make up the V-MUX system.

#### Traditional Wiring



Vs.

#### V-MUX Wiring







## MULTIPLEXING FOR SPECIALTY VEHICLE MARKETS

**Ambulance:**  
 Flashers  
 Climate control  
 Oxygen/suction  
 Dim lighting  
 Cameras

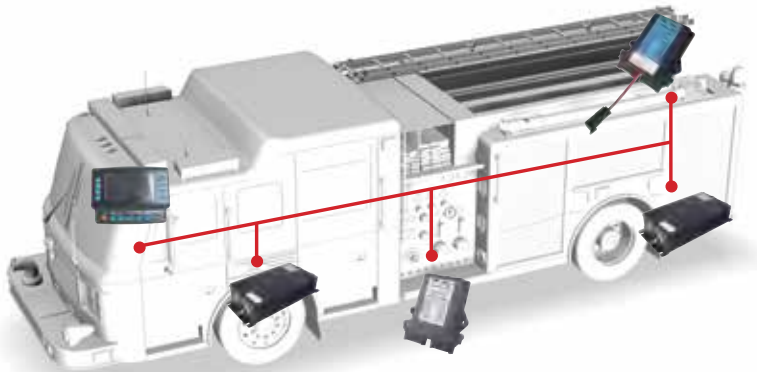
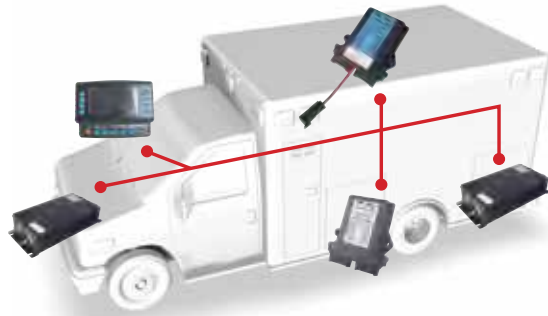

**Fire:**  
 Load shedding  
 Warning light control  
 Pump controls  
 Real-time diagnostics  
 Vehicle data recorder

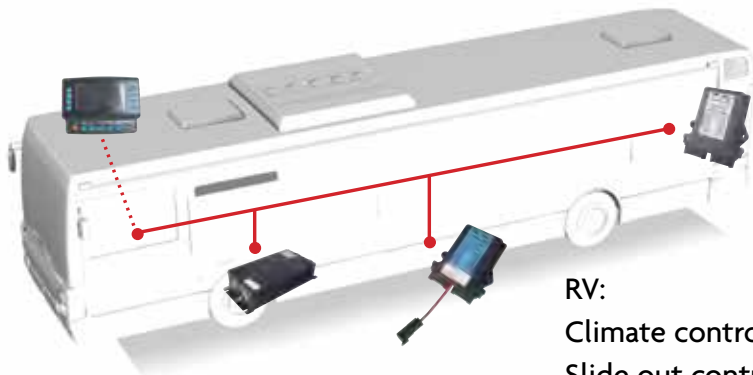

**RV:**  
 Climate control  
 Slide out control  
 Chassis integration  
 Lighting  
 Cameras

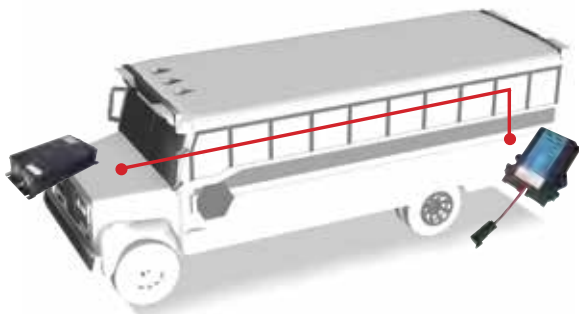

**Bus:**  
 Flash warning lights  
 Child reminder  
 Vehicle data recorder

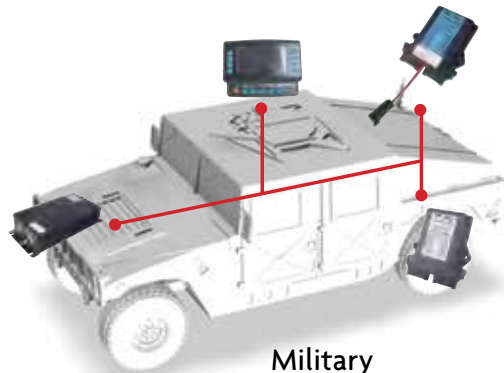

**Military**  
 Real-time diagnostics  
 Climate control  
 Black out mode  
 Rugged high quality

**SystemDesigner® Software**

The V-MUX® SystemDesigner software is an all encompassing tool that allows you to configure your electrical system from the ground up. Whether it is assigning commands to inputs, then assigning those commands to turn on outputs, then assigning the climate control, or designing attractive graphics for your application... SystemDesigner does it all!

- Allows the OEM to configure the vehicle
- User friendly Windows® based software
- Self reliant programming in the hands of the OEM
- Archive all custom designs for future use
- No need to have programmers on staff



Configure your application with our SystemDesigner software.

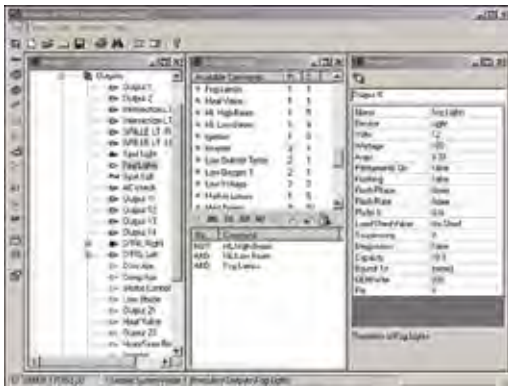

Compile information



Then, flash the node

**V-MUX Downloader Software**

V-MUX's free Download Software provides a solution for the dealer or end user to re-flash or update the vehicle.

- Download changes or program a replacement node
- User friendly Windows® based software
- Software runs on any Windows® system





## V-MUX® Live

The free V-MUX Live capability is included with the latest version of V-MUX Diagnostic Software and V-MUX Downloader Software. Utilization of V-MUX Live requires the local user to connect a web enabled PC/Laptop to the vehicle just as they would to make a local connection, ensure the PC/Laptop is connected to the internet and the V-MUX software is open. The remote user can then easily initiate an V-MUX Live session with the local user through an authenticated connection. The local user must grant the remote user access to complete the connection. V-MUX Live features a “chat” window so the local and remote users can communicate while the session is active. V-MUX Live allows users to take advantage of all features of the Diagnostic and Downloader software.

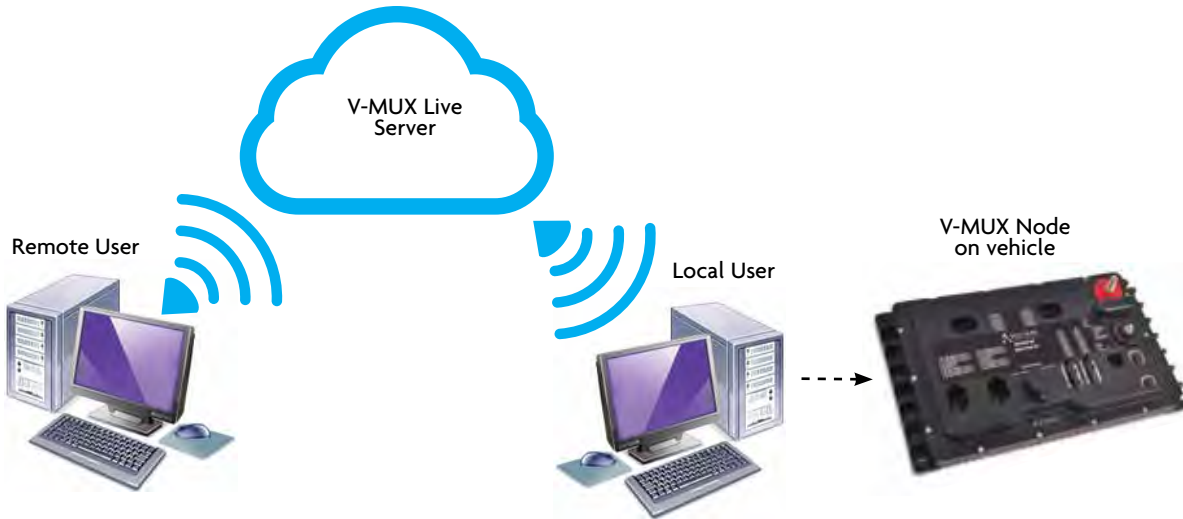

## V-MUX® Diagnostic Software

The free V-MUX Diagnostics Software will aid you in troubleshooting your vehicle. The software will run on all Windows® based systems. We utilize USB to interface between your PC and V-MUX.

V-MUX software utilities, drivers, manuals, and guides are supported 24/7 at [v-mux.com](http://v-mux.com)



## 6131 Series, Field Service Kit

### 6131-0000-00

The V-MUX® Diagnostics kit will aid you in troubleshooting your vehicle, downloading changes or programming a replacement node and includes remote diagnostics. The software will run on Windows 2000, XP, 7, 8, 10 Vista. Software updates can be obtained on our website. For assistance with remote diagnostics, download the manual from the website at [v-mux.com](http://v-mux.com).

Kit Includes:

- Carrying case
- One-on-one cables for nodes
- Deutsch wire removal tool, 14-16 gauge wire (blue)
- Deutsch wire removal tool, 18-20 gauge wire (red)
- Cable, RS232 9 pin serial PC to transceiver
- Cable, RS485 transceiver to V-MUX
- Cable, troubleshoot Hercules outputs, (red)
- Cable, troubleshoot mini node outputs (black)
- Downloader manual, PDF
- Diagnostics manual, PDF



Order Nos.	Description
6131-0000-00	V-MUX Kit, Diagnostics, USB/Downloader



## Vista IV Display

Control your lighting and HVAC with the full color Vista IV display. Now offering new features including: optional touch screen with buttons, 800 x 480 resolution, Four Video Ports, Firmware update by USB. This display has a wide operating temperature range, automatic screen switching in response to current conditions and sleep mode option to eliminate night glare. Available in panel mount or 6" arm mount.

### Features:

- Touch screen optional
- 800 x 480 resolution
- Four video ports
- Flash updates with USB flash drive
- Operates in 12V and 24V applications
- Virtual switches
- Display inside and outside temperature
- Automatic climate control
- 100% configurable (OEM level)
- Field re-programmable
- Peer to peer network
- On-board diagnostics / service information
- Colors change to indicate button status
- Improved sunlight readability
- Video ready for:
  - Backup camera / Thermal cameras
  - DVD
  - GPS



*Touch Screen Option  
Now Available!*



6241-0130-00 Panel Mount with Bezel

Powered USB Plug



6241-0115-00



Flash Updates with  
USB Flash Drive

Vista IV w/ Buttons	
6241-0110-XX	Red/Blue Green Buttons, Panel Mount
6241-1110-XX	Green/Blue/Green Buttons, Panel Mount
6241-0111-XX	Red/Blue Green Buttons, Arm Mount
6241-1111-XX	Green/Blue/Green Buttons, Arm Mount
Vista IV Touch Only	
6241-0115-00	Panel Mount Rear
6241-0130-00	Panel Mount with Bezel
Vista IV Accessories	
XX= Legend – Contact your Akron Brass Sales Rep for a current list of available legends	
0J50-1505-01	6" Swivel Mounting Bracket
OK90-2310-00	Vista IV Connector Kit
OL40-2806-02	16" Video Pigtail

### Technical Specifications:

Operating Voltage	9-32v (12 or 24V)
Operating Temperature	-40°C to +85°C
Electrical Protection	Load dump, jump start, reverse polarity, ESD, EMI/RFI
Real-time Clock	Ten year retention
Mating Connector:	1: Comm. Hi, 2: Comm. Lo, 3: Ground, 4: Power
Startup Time	< 3 seconds

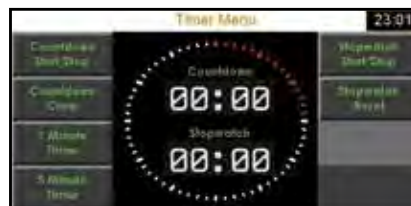



## 6310 Series, PODS

Programmable On Demand Switches (PODS) are self contained, fully multiplexed switch modules. Program the controller and plug in each individual 3-Key or 4-Key Smart Switch Module. Use the OL40-2020-00 cable assembly to daisy chain up to 16 modules. Create custom legends using the OQ20-1736-00 die cut nylon sheet on your laser printer.

Order Nos.	Description
6310-0000-12	V-MUX Programmable Switch Controller, 12V PODS
6310-0000-24	V-MUX Programmable Switch Controller, 24V PODS
6311-0300-00	3-Key Smart Switch Module
6311-0400-00	4-Key Smart Switch Module
OQ20-1736-00	Legend Sheet, 88 per sheet
OL40-2088-00	Controller Cable Assembly for PODS 10 feet
OL40-2020-00	Module to Module Cable Assembly 10 inches
OK90-2311-00	Connector Kit PODS - kit includes all cables



Two 6311-0400-00 connected with OL40-2020-00 cable assembly

## 6300 Series, Blue Touch Switch Panels

The Blue Touch Switch Panels can be used with a V-MUX system or with non multiplexed electrical systems. Create custom legends using the OQ20-1736-00 die cut nylon sheet on your laser printer.

Order Nos.	Description
6300-0400-00	V-MUX Panel, four position
6300-0800-00	V-MUX Panel, eight position
OQ20-1736-00	Legend Sheet, 88 per sheet



6300-0400-00



## Hercules HC

The 6060 series Hercules HC builds upon the proven performance and reliability of the current Hercules 6000 series V-MUX® multiplex node by providing more robust I/O, increased connectivity options, and a lower price than the current Hercules node. V-MUX is a vehicle multiplex system that offers tremendous flexibility to the OEM builder. Integrate standalone vehicle sub systems such as door interlocks, high idle control, voltage monitoring, and vehicle diagnostic troubleshooting. The Weldon SystemDesigner® software allows for easy configuration and programming of Hercules HC node, giving users flexibility and control to use any input or output the way they need.

The Hercules HC node offers more functionality and connectivity at an affordable price, allowing OEM builders to streamline their V-MUX designed vehicles to meet the customer's requirements for multiplex vehicle designs.

- (2) built-in CAN gateway connections
- PODS buttons serial port connection
- VFD port connection
- USB programmable
- Sealed enclosure designed to meet IP67
- Aluminum heat sink designed for 120 amps of current
- Operating temperature of -40°C to +85°C
- 12V and 24V capable
- 32 outputs
- 20 inputs

Order Nos.	Description	Length	Width	Depth	Weight
6060-0000-00	V-MUX Hercules HC Node	13.46"	7.98"	2.65"	5.9 Lbs. (2.67 kg)
0K90-3462-00	Hercules HC Connector Kit	-	-	-	-



Hercules HC  
Back View



Hercules HC  
Side View

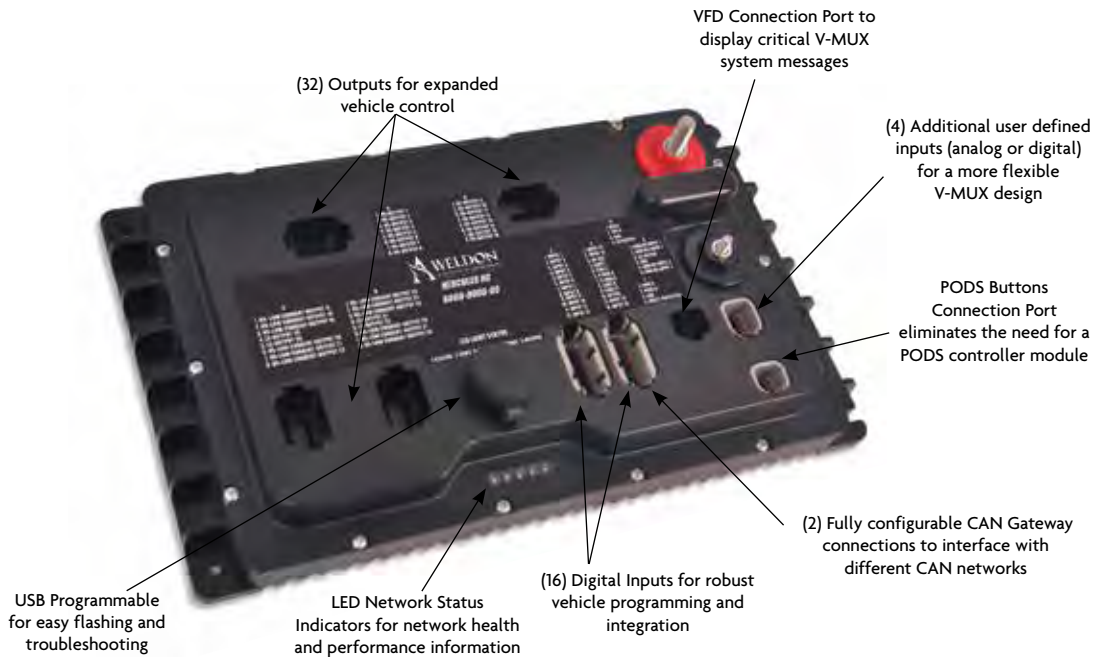





## 6000 Series, Input / Output Node

The "Hercules" node is capable of carrying up to 120 amps of load at high temperatures. For years, this module has been the work horse of thousands of V-MUX systems. Uniquely designed power studs with molded flanges prevent rotation when terminals are overtightened, and provide added protection against water intrusion. All of the Inputs and Outputs are configurable by the OEM.

- Operates in 12V and 24V applications
- Sealed enclosure
- Sealed deutsch connectors
- Corrosion proof
- High capacity
- A & B communication ports
- LED status indicators
- Field re-programmable
- 16 digital inputs
- 3 analog inputs
- 24 positive outputs
- 2 ground outputs
- Control the (OU10-0715-00) VF display



6000-0000-04

Order Nos.	Description
6000-0000-04	V-MUX Hercules Node
0K90-2280-00	Connector Kit Hercules

## 6030 Series, 8 x 16 Input / Output Node

The 8x16 node has 6 Digital and 2 Analog inputs; each input is programmable. The node contains 16 outputs, 14 of which are high side 10.5 amp channels and two are low side 4 amp channels.

- Operates in 12V and 24V applications
- Sealed enclosure
- Sealed deutsch connectors
- Dual communications ports
- LED status indicators
- Field re-programmable
- 6 digital inputs (VBatt or Ground)
- 2 analog inputs (can also be used as VBatt switch)
- 14 positive outputs
- 2 ground outputs



6030-0000-00

Order Nos.	Description
6030-0000-00	V-MUX 8X16 Node
0K90-2286-00	Connector Kit for 8x16 Node

## 6010 Series, 4 x 12 Input / Output Mini Node

The 6010 "mini" node has four independently programmable switch inputs, one analog input and twelve 7.5 amp output channels.

- Sealed deutsch enclosure and connectors
- Corrosion proof
- Compact size
- A & B communication ports
- LED status indicators
- Field re-programmable
- 4 digital inputs
- 12 positive outputs
- Control the (OU10-0715-00) VF display



6010-0000-00

Order Nos.	Description
6010-0000-00	V-MUX Mini Node
0K90-2281-00	Connector Kit for 6010 Node

## 6020 Series, 16 Input Node

The Input Node has 16 independently programmable switch inputs. Each input can be used for door interlocks, dash switches and switch-type sensors. This Input node can interface with the VFD Display (OU10-0715-00)

- Operates in 12V and 24V applications
- Sealed deutsch enclosure and connectors
- Corrosion proof
- Compact size
- A & B communication ports
- LED status indicators
- Field re-programmable
- 16 digital inputs
- Control the (OU10-0715-00) VF display



6020-0000-00

Order Nos.	Description
6020-0000-00	V-MUX Input Module, 16 input
0K90-2282-00	Connector Kit for 6020 and VDR

## Occupant Restraint Indicator

The Occupant Restraint Indicator module works in conjunction with the 6444 Series Vehicle Data Recorder to indicate passenger location and safety equipment status to the driver per NFPA 1901 requirements. The 6204 indicator includes audible and visual warning of unsafe occupant conditions. The Occupant Restraint Indicator works with your vehicle's V-MUX multiplexing system utilizing the Vista IV display.

- Low profile, compact size
- Supports commercial and custom cab seating layouts; up to 12 seats
- Dimming feature adjusts indicator intensity to synchronize with dash lights
- Built-in audible alarm
- Use in conjunction with Vehicle Data Recorder (VDR)



6204-0000-00

Order Nos.	Description
6204-0000-00	Occupant Restraint Indicator - Analog backlight interface
6204-0000-01	Occupant Restraint Indicator - Digital backlight interface
0K90-2783-00	Connector kit for Occupant Restraint Indicator

## Seat Belt Warning System

The Seat Belt Warning System addresses your safety concerns. Designed to alert the driver, the Seat Belt module will indicate when restraints of occupied seats are properly fastened keeping personnel safe. The 6204 Series meets NFPA 1917 requirements for your ambulance. Simple & reliable, the Seat Belt Warning System is based on the patented and proven V-MUX® multiplexing technology.

- Low profile, compact size
- Supports commercial and custom cab seating layouts; up to 10 seats
- Dimming feature adjusts indicator intensity to synchronize with dash lights
- Integrated door open indicator
- Built-in audible alarm will sound when Seat Belt Indicator display is red & parking brake is released
- Choose from display with door and warning ICONS or just seats
- Standard 4 year warranty
- Use the 6020 node as an entry point system - upgrade to the optional 6444 Vehicle Data Recorder (VDR)



6204-0014-01

6204-0024-01

Order Nos.	Description
6204-0014-00	Ambulance Seat Indicator w/Door Ajar - Analog Backlight
6204-0014-01	Ambulance Seat Indicator w/Door Ajar - Digital Backlight
6204-0024-00	Ambulance Seat Indicator - Analog Backlight
6204-0024-01	Ambulance Seat Indicator - Digital Backlight



AIR  
HORN





## Vehicle Data Recorder (VDR) / Gateway

The Vehicle Data Recorder collects essential data and can easily be interfaced with V-MUX Multiplex System. Reviewing the information is made easy with an intuitive computer application. The VDR is NFPA 1901-2009 compliant.

- Recorded Data Includes: Vehicle Speed, Acceleration, Deceleration, Engine Speed, Engine Throttle Position, ABS Event, Seat Occupied Status, Seat Belt Status, Master Optical Warning Switch, Park Brake, Service Brake, Time, and Date
- Password protected by the customer
- Six (6) seat position inputs for occupied Seats and belts buckled. Additional six (6) seat expansion module available (p/n 6020-0000-00)
- Use as a V-MUX Gateway node and input node
- Data is extracted via USB
- Use in conjunction with the Occupant Restraint Indicator or V-MUX Multiplex System



Order Nos.	Description
6444-0000-00	Vehicle Data Recorder (VDR)
OL40-2597-00	Download Cable -USB to Deutsch
OK90-2282-00	Connector Kit for 6020 and VDR

6444-0000-00

## ON70 Climate Control Module

Use this module with Vista IV display node for fully automated climate control system.

- Dedicated node specifically for climate control
- Control two fans, AC Compressor, condenser, evaporator switches and other interlocks
- Use this module with a Vista IV display node for a fully automated climate control system

Order Nos.	Description
ON70-1519-03	Climate Controller Fahrenheit
ON70-1519-04	Climate Controller Celsius
OK90-2763-00	Connector Kit Climate Module

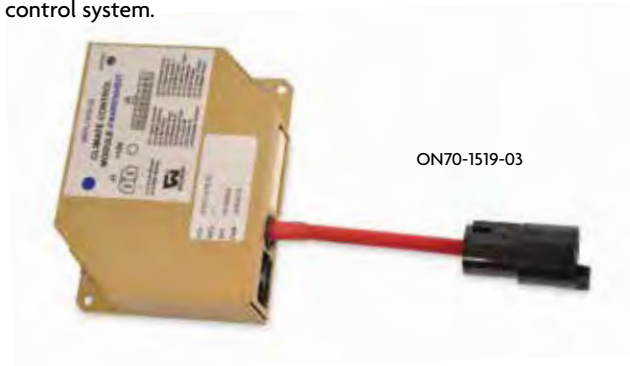

ON70-1519-03

## OR13 Series, Temperature Sensor

This sensor is used to report interior or exterior temperature. This data can be displayed, reported or used for A/C, heat, ice warning or other automatic functions.

Order Nos.	Description
OR13-0614-00	V-MUX Temperature Sensor, 3 wire
OR13-2557-00	V-MUX Temperature Sensor, 2 wire



OR13-0614-00

## V-MUX VFD Display

Two-line, twenty character text display is capable of showing a wide range of data from the V-MUX System. Directly runs off any V-MUX I/O node.

Examples of text:

- Display on command "Set Park Brake"
- Display diagnostics codes
- Display warnings - "ice" or "door ajar"
- Programmable messaging

Order Nos.	Description
OU10-0715-00	V-MUX VFD Display
OK14-2073-00-00	3 Pin Connector



OU10-0715-00

Call Customer Care for specification details



## Diamondback™ V-LED Perimeter Warning Lamps

With incredible brightness, directional visibility, customized flash and styling flexibility, and unique serviceability; the patented Diamondback V-LED Perimeter Warning Lamp.

### Exclusive Features:

- Exceeds industry requirements (NFPA, SAE, KKK-A-1822)
- High impact polycarbonate lens with scratch and haze resistant hard-coating provides a lifetime of durability and clarity
- Flush mount design utilizes only four screw holes and a wire exit hole in vehicle. Mounting pattern is common with most competitive lamps.
- Injection molded mounting pad is integrated with lamp head
- Four-wire lamp hook-up (power, ground, sync, and secondary enable wires)
- Chrome trim bezel option with injection molded gasket
- 12 and 24V operation
- Protected against reverse polarity, ESD, and transient voltage spikes (J1113-11)
- Fully tested for RF interference and susceptibility
- 5 year warranty

### Lamp Configuration:

- Available in 2"x6", 3"x4", 3"x7", 4"x6", & 7"x9"
- Independently controlled LED segments allow for unmatched flash pattern options (left/right, up/down, x-pattern, chasing, and many more)
- Lamp is completely reconfigurable via wireless download without removing lens or lamp from vehicle



V46W-C00R  
Shown with Bezel OB80-2336-00



V46W-R  
Shown with Bezel OB80-2336-00



Patented V-LED design allows replacement of LEDs

## Diamondback IR Programmer

### 0N60-2508-00

Diamondback IR Programmer for use with Diamondback warning lights. The IR Programmer allows for a quick and wireless way to re-configure all Diamondback flash patterns on your vehicles.



IR Programmer for  
Diamondback™ Lights  
0N60-2508-00

Order Nos.	Description
0N60-2508-00	Diamondback Wireless Programming Device







## Diamondback™ LED Perimeter Warning Lamps



2" x 6"



3" x 4"



3" x 7"



4" x 6"

Lamps shown with Bezels - ordered separately.

## Model Number Configuration Guide



7" x 9"

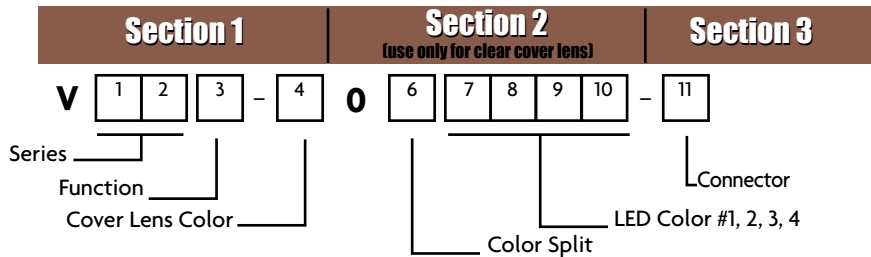

### Section 1

1	2	Series	3	Function	4	Cover Lens Color
3	4	= 3" x 4"	W	= Warning	R	= Red
3	7	= 3" x 7"	S	= Scene	C	= Clear
4	6	= 4" x 6"				
7	9	= 7" x 9"				

If Cover Lens Color is "C" Use Section 2; otherwise skip directly to section 3

### Section 2

6	Color Split	None	Horizontal	7	8	9	10	LED Color #1	LED Color #2	LED Color #3	LED Color #4
0	= None										
H	= Horizontal										
V	= Vertical										
X	= "X"										
Q	= Quad										
Only applies to clear cover lens											
		Quad									
		1 2	1 1	1 1	1 1						
		3 4	1 1	2 2	2 2						
			Vertical								
			1 2	1 2	"X"						
			1 2	2 1	2 1						

R = Red  
A = Amber  
W = White  
B = Blue  
G = Green  
Only applies to clear cover lens

### Section 3

11	Connector
2	= Deutsch
0	= None

## Sample Diamondback Part Numbers

Order Nos.	2"X 6" * Diamondback (DB) Descriptions	CTN
V26W-C00A	2X6 DB Amber LEDs W/ Clear Lens	1
V26W-C00W	2X6 DB White LEDs With Clear Lens	1
V26W-C0VRW	2X6 DB, Red/White LEDs, Vert Split	1
Order Nos.	3" x 4" ** Diamondback (DB) Descriptions	CTN
V34W-R	3X4 DB Red LEDs W/ Red Lens	1
V34W-C00W	3X4 DB White LEDs With Clear Lens	1
V34W-C0HRW	3X4 DB Red/White LEDs, Horz Split	1
Order Nos.	3" x 7" Diamondback (DB) Descriptions	CTN
V37W-C00R	3X7 DB Red LEDs W/ Clear Lens	1
V37W-C0HRA	3X7 DB Red/Amber LEDs, Horz Split	1
Order Nos.	4" x 6" Diamondback (DB) Descriptions	CTN
V46W-R	4X6 DB Red LEDs W/ Red Lens	1
V46W-C00W	4X6 DB White LEDs With Clear Lens	1
Order Nos.	7" x 9" Diamondback (DB) Descriptions	CTN
V79W-C00W	7X9 DB White LEDs With Clear Lens	1

Order Nos	Service Parts for Diamondback Series	CTN
OB80-2495-00	Chrome Bezel Kit for 2"X6" Diamondback Lamps	1
OB80-2334-00	Chrome Bezel Kit for 3"X4" Diamondback Lamps	1
OB80-2335-00	Chrome Bezel Kit for 3"X7" Diamondback Lamps	1
OB80-2336-00	Chrome Bezel Kit for 4"X6" Diamondback Lamps	1
OB80-2337-00	Chrome Bezel Kit for 7"X9" Diamondback Lamps	1
0C20-3605-xx	V26 replacement cover lens	1
0C20-3604-xx	V34 replacement cover lens	1
0C20-3603-xx	V37 replacement cover lens	1
0C20-3602-xx	V46 replacement cover lens	1
0C20-3601-00	V79 replacement cover lens	1

Note: Denote xx (-10) red lens, (-30) clear lens,  
\* V26W available in vertical split (left/right) only  
\*\* V34W available in horizontal split (top/bottom) only





## 3800 / 4600 / 7800 Series, LED Warning Lamps

Weldon's 3800, 4600, and 7800 series warning lamps are available in LED, Halogen or Strobe. The lens and reflector are sealed eliminating the problems of dust and moisture infiltration. All versions are available as a panel mount, or with a chrome trim flange. The LED versions contain a triple seal mating connector. The Halogen versions use an automotive style twist and lock socket that allows for easy, off-the-shelf bulb service.

- Superior light output
- Sealed lens and housing
- Sealed, integrated connector
- Panel or chrome flange mount
- LED function in 12V and 24V applications
- 5 year warranty on LED lamps

Description	LED Amp Draw 12 V	LED Amp Draw 24V	Halogen Amp Draw 12V	Strobe Amp Draw
3" X 7" warning	0.8	0.42	4.2	*
4" X 6" warning	0.9	0.35	4.2	*
7" X 9" warning	2.3	1.18	4.2	*

\* Amp draw varies based on power supply used

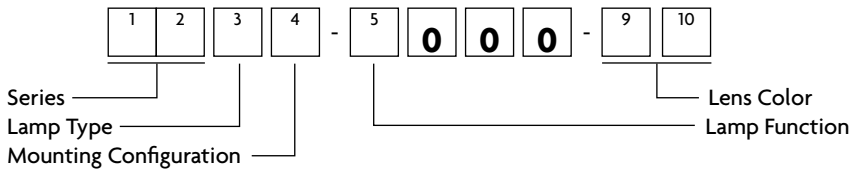

3871-1000-10

1	2	Series	3	Lamp Type	4	Mounting Configurations	5	Lamp Function
3	8	= 3x7 Warning Lamp	1	= Halogen	1	= Panel Mount	0	= Non LED Lamp (Halogen or Strobe)
4	6	= 4x6 Warning Lamp	2	= Strobe	2	= Chrome Bezel (Flange) Mount	1	= LED Warning Lamp
7	8	= 7x9 Warning Lamp	7	= LED				

9	10	Lens Color
1	0	= Red
2	0	= Amber
3	0	= Clear
4	0	= Blue

### Split Lens Options (For Halogen and Strobe Lamps Only)

- 1 2 = Amber / Red
- 1 3 = Red / Clear
- 1 4 = Red / Blue
- 2 1 = Amber / Red
- 2 4 = Amber / Blue
- 3 1 = Clear / Red
- 3 4 = Clear / Blue
- 4 1 = Blue / Red
- 4 2 = Blue / Amber
- 4 3 = Blue / Clear

### 3800, 4600, 7800 Series Service Parts

Order Nos.	Service Parts	CTN
OE22-0327-00	Repl. Bulb #795, Halogen	100
OK90-0336-00	Repl. Socket, single contact	10
OC90-1028-xx	Repl. Hal. lens/reflector assembly 3"X7"	6
OM10-1328-xx	Repl. Strobe head assembly 3"X7"	6
OC90-0350-xx	Repl. Hal. lens/reflector assembly 4"X6"	6
OM10-1330-xx	Repl. Strobe head assembly 4"X6"	6
OC90-1138-xx	Repl. Hal. lens/reflector assembly 7"X 9"	6
OM10-1428-xx	Repl. Strobe head assembly 7"X 9"	6
OB53-1016-00	3" X 7" Chrome bezel	6
OD30-1026-00	3" X 7" Mounting pad, bezel mount	6
OD10-1025-00	3" X 7" Gasket between lamp and bezel	6
OD30-1027-00	3" X 7" Mounting pad, panel mount	6
OB53-0333-00	4" X 6" Chrome bezel	6
OD30-0377-00	4" X 6" Mounting pad, bezel mount	6
OD10-0334-00	4" X 6" Gasket between lamp and bezel	6
OD30-0385-00	4" X 6" Mounting pad, panel mount	6
OB53-1125-00	7" X 9" Chrome bezel	6
OD30-1136-00	7" X 9" Mounting pad, bezel mount	6
OD10-1135-00	7" X 9" Gasket between lamp and bezel	6
OD30-1137-00	7" X 9" Mounting pad, panel mount	6



4672-1000-20



4621-0000-10



7812-0000-20



7822-0000-40



3821-0000-12



## 7400 Series, Strobe Power Systems

For new or retrofit applications. Power supply for NFPA or GSA-KKK vehicles. User-selectable flash patterns: dual, quad or random flash patterns. Three wire, shielded heavy-duty strobe cable offers connectors installed and is available in various lengths. Operates in 12V or 24V applications.

Order Nos.	Description
7404-0060-00	Strobe pack, 4-channel 60w
7414-0090-00	Strobe pack, 4-channel 90w



## 3200-0000-13, Supplemental Warning Lamp Kit

The kit developed with Ohio transportation officials, highway patrol, and school districts to reduce stop arm violations, the kit positions supplemental LED warning lamps at bumper level on the bus (fore and aft) to provide an attention demanding signal that is more perceptible to a distracted motorist than the standard 8 lamp system alone.

- Supplemental LED lights provide increased safety when loading and unloading students
- Reduces the number of illegal passers
- Lights are active when stop arm is deployed enhancing driver visibility
- Complement to the national standard for school bus lighting FMVSS-108
- Approved as a safety option by the State of Ohio Highway Patrol

Order Nos.	Description
3200-0000-13	Supplemental Warning Lamp Kit, Red - White
3200-0000-11	Supplemental Warning Lamp Kit, Red - Red
3201-0000-13	Supplemental Warning Lamp, Red - White
3201-0000-11	Supplemental Warning Lamp, Red - Red



## 8401-0000-20, LED Door Warning Lamp

The 8401 Door Warning Lamp is an ideal auxiliary warning light for your emergency vehicle application. Mounted on your apparatus doors, the light strip contains LEDs and specialized optics to emit an amber light flashing pattern that directs traffic away from the doors when open. Enhancing safety, Weldon engineers designed the optics specifically to throw the light away from the operators' eye and toward approaching traffic.

- Length: 16" Height: 3/4" Depth: 5/8"
- 15 traffic directing amber LEDs
- Sealed construction for excellent moisture protection
- Voltage: 12 V (.09 amp draw)



Order Nos.	Description	Amp Draw 12V	CTN
8401-0000-20	Door warning lamp, amber	.09	50





## 1020-9000 Series, 7" V-LED Warning Lamp

V-LED Warning Lamp which combines advanced electronics plus a conventional idea of just replacing a broken lens. Designed with serviceability in mind, the new warning light can be disassembled to change the lens or upgrade LED's, eliminating the need to replace the entire light. The 1020-9000 Series light provides industry leading thermal management, low current draw and lower long-term cost than ordinary lights. No other 7" LED Warning Light offers "service made easy" with upgradeable LED technology.

- Exclusive patented V-LED technology for superior thermal efficiency and excellent brightness
- Utilizes only 8 high-power LED's for optimal output intensity, fully illuminating the entire lens
- Cover lens is replaceable
- LED's are serviceable/upgradable
- Standard lead wires allow flexibility to add the connector of choice
- Exceeds SAE J887 requirements - DOT (FMVSS108) compliant
- Strobing and standard flash in one lamp
- Instant on for improved visibility and safety
- No switch mode regulation - eliminates radio interference
- Advanced lens design for maximum optical performance
- 5 year warranty

Order Nos.	Description	Amp Draw 12V	CTN
1020-9000-10	7" LED serviceable red Warning	1.0	12
1020-9000-20	7" LED serviceable amber Warning	1.5	12
1020-9030-xx	7" Serviceable LED Warning Lamp, AMP 250 Series connector	1.0 red 1.5 amber	12
1020-9090-xx	7" Serviceable LED Warning Lamp, Single AMP Univ Mate-N-Lok connector	1.0 red 1.5 amber	12

xx denotes (-10 red) or (-20 amber)

Order Nos.	Service Parts	CTN
0C20-2312-XX	Cover lens for 1020-9000	12
0C10-2313-00	Inner lens for 1020-9000	12
0D10-2316-00	Lens gasket	12
0D10-1977-00	Mounting gasket	12
0E30-2262-12	12 pack V-LED kit, red	1
0E30-2262-23	12 pack V-LED kit, amber	1
1021-0000-00	Visor for 1020	60



1020-9000-10



1020-9000-20



Connector for the 1020-9030 & 1020-5030



Connector for the 1020-9090 & 1020-5090

## 1020-5000 Series, LED Warning Lamp

### 1020-5000

High-brightness LED Warning Light which combines advanced electronics and efficient optical elements. The warning lamp includes five state-of-the-art high power LEDs that project an intense signal. The 1020-5000 Series light provides industry leading thermal management, low current draw and lower long-term cost than ordinary lights.

- Utilizes 5 high-power LED's for optimal output intensity
- Dual lenses efficiently distribute the light from the LEDs, fully illuminating the entire lens
- Low amp draw
- Standard lead wires allow flexibility to add the connector of choice
- Exceeds SAE J887 requirements
- DOT (FMVSS108) compliant
- Strobing and standard flash in one lamp
- Instant on for improved visibility and safety
- No switch mode regulation
- No radio interference
- 5 year warranty

Order Nos.	Description	Amp Draw 12V	CTN
1020-5000-xx	7" LED Warning lamp	1.10 Red 1.60 Amber	12
1020-5030-xx	7" LED Warning lamp w/AMP 250 Series Connector	1.10 Red 1.60 Amber	12
1020-5090-xx	7" LED Warning lamp w Single AMP Univ Mate-N-Lok connector	1.10 Red 1.60 Amber	12

xx denotes (-10 red) or (-20 amber)



1020-5000-20

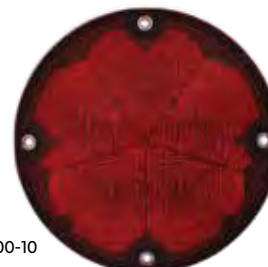

1020-5000-10

## 1017-9000 Series, 7" Round, Single V-LED

Designed for long-term service and low lifecycle costs, Weldon's 1017-9000 Series offers the best of both worlds —combining the benefits of Weldon's patented V-LED technology in a traditional look. It is the industry's only serviceable, maintainable, and upgradable stop, tail, turn, and backup light. It is loaded with value-added features that reduce maintenance expenses and vehicle downtime, while enhancing signaling and visibility through optimized light control. Some of the key features/benefits include:

- Replaceable cover lens serviceable on the vehicle
- Serviceable V-LED
- Low power consumption/amperage draw
- Backup lamp available page 122
- 5 year warranty



1017-9000-10



1017-9000-20

Part Number	Description	Amp Draw 12V	CTN
1017-9000-10	Stop & Tail, Single V-LED, 7" Round, Red Lens	.57/.06	12
1017-9000-20	Rear Turn, Single V-LED, 7" Round, Amber Lens	.57/.06	12
OC80-2684-XX	Replacement cover lens kit		12
OE30-2262-12	V-LED Kit, 1 watt, Red, 12 pcs		1
OE30-2262-23	V-LED Kit, 2 watt, Amber, 12 pcs		1

Note: xx Denote (-10) red lens, (-20) amber lens

## 7" LED Stop, Turn & Tail Lamps

This 7" diameter series is available in two LED versions.

### LED, 9186-5585 Series

- Economically priced
- Low amp draw
- Backup available page 122

Order Nos.	Description	Amp Draw 12V	CTN
9186-5585-10	7" econ. LED, stop & tail, reflex, red	.54/.03	12
9186-5585-20	7" econ. LED, park & turn, reflex, amber	.54/.03	12
9186-5586-10	7" econ. LED, stop & tail, red	.54/.03	12
9186-5586-20	7" econ. LED, Park & Turn, Amber	.54/.03	12



9186-5585-20



9186-5585-10

## 1000 / 1010 Series, 7" Incandscnt Stop, Turn & Tail Lamps

- Stainless Steel bodies now available

Order Nos.	Description	Amp Draw 12V	CTN
1000-1100-20	7" turn w/arrow, socket back, black base, sgl cont #1156 bulb	2.1	24
1000-1106-20	7" turn w/arrow, ground wire, socket back, black base, sgl cont #1156 bulb	2.1	24
1010-1100-xx	7" stop or turn, socket back, black base, #1156 bulb	2.1	24
1010-1120-xx	7" stop & tail/ park & turn, socket back, black base, dual cont #1157 bulb	2.1/.59	24
1010-1126-xx	7" stop & tail, black base, socket back, ground wire, dual cont #1157 bulb	2.1/.59	24
1002-0000-xx	Repl. lens, acrylic, arrow 7" round		24
1003-0000-xx	Repl. lens, acrylic		24
1014-0000-00	Repl. gasket, lens		24
1015-0000-00	Repl. mounting pad for black base		24
9018-0013-00	Repl. bulb: #1156 bulb, 32CP		100
9018-0020-00	Repl. bulb: #1157 bulb, 32/3CP		100
1005-1100-XX	7" turn w/arrow, socket back, stainless steel base, sgl cont #1156 bulb	2.1	24
1010S-1100-XX	7" stop or turn, socket back, stainless steel, sgl cont #1156 bulb	2.1	24
1010S-1200-XX	7" stop & tail/ park & turn, socket back, stainless steel, dual cont #1157 bulb	2.1/.59	24
OE17-3623-00	Repl. bulb: #2057, 32/2 CP for stainless steel		

NOTE: xx Denote (-10) red Lens (-20) Amber Lens



1010-1120-10

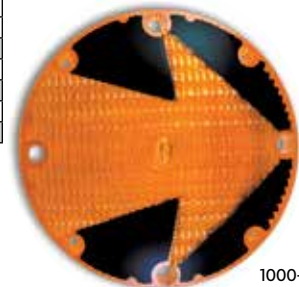

1000-1100-20



# Stop, Turn & Tail Lighting



WELDON VEHICLE LIGHTING & ELECTRICAL CONTROL



## 9186 Series, 4" Round and 6" Oval

This lamp series is available in LED or incandescent. The kit contains the lamp, mounting grommet and plug.

- Electrical "sure seal" connector for a weatherproof seal
- Low amp draw for the LED
- Sealed lamps keep out moisture and dirt

Order Nos.	Description	Amp Draw 12v	CTN
9186-5300-10	4" stop & tail lamp kit, 3-wire, grommet mt, red	2.9/0.6	50
4040-0109-10	4" LED stop & tail lamp kit, 3-wire, grommet mt, red	0.1/0.2	50
9186-5525-20	4" LED turn & park lamp kit, 3-wire, grommet mt, amber	0.4/0.2	50
9186-2610-20	6" oval turn signal lamp kit	2.9/0.6	50
OK90-1291-20	Replacement 3 wire/plug for 9186-5525		10



9186-5300-10



4040-0109-10



9186-5525-20



9186-2610-20

## 2350 Series, LED Combination Lamp

This OEM heavy truck qualified lamp features Stop, Tail, Turn, Reverse and License (2351 only) functions in a single lamp. The LED light sources are automotive grade for reliable long-term operation. Plastic construction with stainless steel mounting hardware insures years of corrosion free service. The integral sealed connector provides easy hook-up to the vehicle harness. Mounting bolt pattern matches most popular rear box lamp configurations.

Order Nos.	Description	Amp Draw 12V			CTN
		Stop/Turn	Tail/License	Reverse	
2351-0100-00	Rear Combination Lamp w/License	.12	.11	.20	24
2352-0100-00	Rear Combination Lamp w/o License	.12	.01	.20	24
OK90-3307-00	Plug Assembly, 4-Wire for 2351				24
OK90-3308-00	Plug Assembly, 4-Wire for 2352				24
2350-0000-00	LED Rear Combination Light Kit				1
OL40-3528-00	Harness				1



2351-0100-00



2351-0100-00  
Bottom View



## 9186 Series, Outrigger Lamp

This dual faced outrigger lamp addresses illumination for aerial applications. Tough polycarbonate lenses are sealed to keep electronics free from moisture and dirt.

- Polycarbonate lenses
- Fully encapsulated electronics
- Chrome plated, die-cast zinc housing
- Pedestal mount
- Measures 4.17" diameter x 4.6" tall x 1.69" wide

Order Nos.	Description	Amp Draw 12V	CTN
9186-2366-10	LED Dual-Face Red/Red	0.7	12



9186-2366-10

## 3800 Series, 3" X 7" Stop, Turn, and Tail Lamps

### LED

- Unsurpassed light output
- Sealed lens and housing
- Available in panel or chrome flange mount
- Sequential arrow turn can be used to supplement your standard DOT approved turn signal
- Integrated 3-pin, triple seal connector
- Operates in 12 and 24V applications
- 5 year warranty

Order Nos.	Description	Amp Draw 12V	Amp Draw 24V	CTN
3871-2000-10	3"x7" LED, stop & tail, panel mount, red	.65/.11	.31/.04	1
3871-6000-21*	3"x7" LED, seq turn w/arrow lh, panel mount, amber	0.89	0.4	1
3871-6000-22*	3"x7" LED, seq turn w/arrow rh, panel mount, amber	0.89	0.4	1
3872-2000-10	3"x7" LED, stop & tail, bezel mount, red	.65/.11	.31/.04	1
3872-6000-21*	3"x7" LED, seq turn w/arrow lh, bezel mount, amber	0.89	0.4	1
3872-6000-22*	3"x7" LED, seq turn w/arrow rh, bezel/amber	0.89	0.4	1

\* Supplemental use only. Must be paired with FMVSS 108 certified signal.



3871-2000-10



3872-0100-20

## 3800 Series, 3" X 7" Stop, Turn, and Tail Lamps

### Incandescent

- Available in panel mount, or with a chrome trim flange
- Single or dual contact
- Twist lock socket for easy bulb service
- 12V only

Order Nos.	Description	Amp Draw 12V	CTN
3841-0000-10	3"x7" stop or tail, #1156 bulb, panel mount, red	2.1	6
3841-0000-20	3"x7" turn #3497 bulb, panel mount, amber	2.1	6
3841-0000-21	3"x7" turn w/arrow lh, #3497 bulb, panel mount, amber	2.1	6
3841-0000-22	3"x7" turn w/arrow rh, #3497 bulb, panel mount, amber	2.1	6
3842-0000-10	3"x7" stop or tail, #3497 bulb, bezel mount, red	2.1	6
3842-0000-20	3"x7" turn, #3497 bulb bezel mount, amber	2.1	6
3842-0000-21	3"x7" turn w/arrow lh, bezel mount, #3497 bulb, amber	2.1	6
3842-0000-22	3"x7" turn w/arrow rh, bezel mount, #3497 bulb, amber	2.1	6
3851-0000-10	3"x7" stop & tail, #2357 bulb, panel mount, red	2.2/.59	6
3851-0000-20	3"x7" park & turn, panel mount, #2357 bulb, amber	2.2/.59	6
3852-0000-10	3"x7" stop, turn & tail, bezel mount, #2357 bulb, red	2.2/.59	6



3841-0000-10



3841-0000-20



## 4600 Series, 4" X 6" LED Stop, Turn & Tail Lamps

### LED

- Low amp draw
- Unsurpassed light output
- Sealed lens and housing
- Available in panel, chrome flange, or headlamp mount
- Sequential arrow turn can be used to supplement your standard DOT approved turn signal
- Integrated 3-pin, triple seal connector
- Operates in 12V and 24V applications
- 5 year warranty

Order Nos.	Description	Amp Draw 12V	Amp Draw 24V	CTN
4671-2000-10	4"X6" LED, stop & tail, panel mount, red	.69/.12	.31/.04	1
4671-6000-21*	4"X6" LED turn w/seq arrow lh, panel mount, amber	0.81	0.68	1
4671-6000-22*	4"X6" LED Turn w/Seq Arrow Rh, Panel Mount, Amber	0.81	0.68	1
4672-2000-10	4"X6" LED, stop & tail, bezel mt, red	.69/.12	.31/.04	1
4672-6000-21*	4"X6" LED turn w/seq arrow lh, bezel mount, amber	0.81	0.68	1
4672-6000-22*	4"X6" LED turn w/seq arrow rh, bezel mount, amber	0.81	0.68	1
4673-6000-21*	4"X6" LED turn w/seq arrow lh, head lamp mount, amber	0.81	.31/.04	1
4673-6000-22*	4"X6" LED turn w/seq arrow rh, head lamp mount, amber	0.81	0.68	1

\* Supplemental use only. Must be paired with FMVSS 108 certified signal.



4671-2000-10



4672-6000-21

## 4600 Series, 4" X 6" Incandescent

### Incandescent

- Available in panel mount, or with a chrome trim flange
- Single or dual contact
- Twist lock socket for easy bulb service
- 12V operation

Order Nos.	Description	Amp Draw 12V	CTN
4641-0000-10	4"x6" stop or tail, panel mount, red	2.1	6
4641-0000-20	4"x6" turn, #1156 bulb, panel mount, amber	2.1	6
4641-0000-21	4"x6" turn w/arrow lh, #1156 bulb, panel mount, amber	2.1	6
4641-0000-22	4"x6" turn w/arrow rh, #1156 bulb, panel mount, amber	2.1	6
4642-0000-10	4"x6" stop or tail, #1156 bulb, bezel mount, red	2.1	6
4642-0000-20	4"x6", turn, #1156 bulb, bezel mount, amber	2.1	6
4642-0000-21	4"x6" turn, w/arrow lh, #1156 bulb, bezel mount, amber	2.1	6
4642-0000-22	4"x6" turn, w/arrow rh, #1156 bulb, bezel mount, amber	2.1	6
4643-0000-20	4"x6" turn, headlamp mount, #1156 bulb, amber	2.1	6
4643-0000-21	4"x6" turn w/arrow lh, headlamp mount, #1156 bulb, amber	2.1	6
4643-0000-22	4"x6" turn w/arrow rh, headlamp mount, #1156 bulb, amber	2.1	6
4651-0000-10	4"x6" stop & tail, panel mount, #1157 bulb, red	2.1/.59	6
4651-0000-20	4"x6" park & turn, panel mount, #1157 bulb, amber	2.1/.59	6
4652-0000-10	4"x6" stop & tail, bezel mount, #1157 bulb, red	2.1/.59	6
4652-0000-20	4"x6" park & turn, bezel mount, #1157 bulb, amber	2.1/.59	6
4653-0000-20	4"x6" park & turn, headlamp mount, #1157 bulb, amber	2.1/.59	6



4651-0000-10



4641-0000-21

## Service Parts for 4600 series Stop/Tail and Turn

Order Nos.	Service Parts For 3800, 4600, 7800 S-T-T	CTN
OC90-0350-xx	Repl. lens assy, hal-sf, 4600 series	6
OC90-0351-xx	Repl. lens assy, hal-df, 4600 series	6
OC90-0352-xx	Repl. lens assy, arrow, hal, 4600 series	6
OD30-0377-00	Repl. mounting pad, 4600 series, bezel	6
OD30-0385-00	Repl. mounting pad, 4600 series, panel	6
OK90-0336-00	repl. socket, single contact	6
OK90-0337-00	Repl. socket, dual contact	6
9018-0013-00	Repl. bulb: #1156 bulb, 32cp	6
9018-0020-00	Repl. bulb: #1157 bulb, 32/3CP	6

NOTE: xx Denote (-10) red, (-20) amber, (-21) left, (-22) right



## Tri Cluster Tall Lamp Assemblies

Save Installation time and labor with our total surface mount tail lamp assemblies, they are ready to mount straight out of the box.

- Available in LED or incandescent options
- Sealed lamp design, no moisture or dirt issues.
- Easy to install

Order Nos.	Description	CTN
3884-0000-18	Tri: 3"x7" LED, stop & tail, seq turn lh*, backup*	4
3884-0000-19	Tri: 3"x7" LED, stop & tail, seq turn rh*, backup*	4
3884-0100-01	Tri: 3"x7" lamps, stop & tail, amber turn w/arrow lh, backup, packard con	4
3884-0100-02	Tri: 3"x7" lamps, stop & tail, amber turn w/arrow rh, backup, packard con	4
3884-0100-18	Tri: 3"x7" lamps, LED, stop & tail, amber seq turn lh*, backup*, packard con	4
3884-0100-19	Tri: 3"x7" lamps, LED, stop & tail, amber seq turn rh*, backup*, packard con	4
3884-0100-28	Tri: 3"x7" lamps, LED, stop & tail, amber seq turn lh*, incdsnt backup, packard con	4
3884-0100-29	Tri: 3"x7" lamps, LED, stop & tail, amber seq turn rh*, incdsnt backup, packard con	4
3884-0200-18	Tri: 3"x7" lamps, LED, stop & tail, amb seq turn lh*, backup*, duetsch con	4
3884-0200-19	Tri: 3"x7" lamps, LED, stop & tail, amb seq turn rh*, backup*, duetsch con	4

Order Nos.	Description	CTN
4684-0100-18	Tri: 4"x6" lamps: LED stop & tail, amber seq turn lh*, backup*, packard con	4
4684-0100-19	Tri: 4"x6" lamps: LED stop & tail, amber seq turn rh*, backup*, packard con	4
4684-0200-01	Tri: 4"x6" lamps: stop & tail, amber w/arrow lh, backup, duetsch con	4
4684-0200-02	Tri: 4"x6" lamps: stop & tail, amber w/arrow rh, backup, duetsch con	4
4684-0200-28	Tri: 4"x6" lamps: LED stop & tail, amber seq turn lh*, incdsnt backup, duetsch con	4
4684-0200-29	Tri: 4"x6" lamps: LED stop & tail, amber seq turn rh*, incdsnt backup, duetsch con	4

\*Supplemental use only. Must be paired with FMVSS 108 certified signal.



4684-0100-18



3884-0100-18

## 7" Backup Lamps

Weldon's 7" backup lamps are available in LED and incandescent. Commonly used with the 1000 and 1010 stop, tail, turn lamps.

### 1017-9000 Series, 7" Round, Single V-LED

- Replaceable cover lens serviceable on the vehicle
- Upgradeable V-LED
- Single V-LED design
- Low power consumption/amperage draw
- DOT (FMVSS108) compliant
- Use with 1017 stop, tail and turn, See page 116
- 5 Year warranty

Order Nos.	Description	CTN
1017-9000-30	Backup, Single V-LED, 7" Round, Clear Lens	12
0C80-2684-30	Replacement cover lens kit for 1017 backup	12
0E30-2262-37	V-LED Kit, 1 watt, Clear, 12 pcs	1



1017-9000-30  
V-LED™

### LED, 9186-5585-30 Series

- Low amp draw
- 20 LED's
- Fully encapsulated electronics
- Flat back design

Order Nos.	Description	Amp Draw 12V	CTN
9186-5586-30	7", econ. LED, black base	.26	12



9186-5586-30  
LED

### Incandescent, 1013 Series

- Your choice of chrome flange or black base
- Available in flat back or socket back
- DOT (FMVSS108) compliant

Order Nos.	Description	Amp Draw 12V	CTN
1013-1100-30	7", socket back, black base, #1141 bulb, clear	1.9	24
1003-1000-30	Repl. lens, acrylic, clear		24
1014-0000-00	Repl. gasket, lens		24
1015-0000-00	Repl. mounting pad for panel mount		24
1016-0000-00	Repl. mounting pad for chrome flange mount		24
9018-0019-00	Repl. bulb #1141, 21cp		100



1013-1100-30  
Incandescent





## 3800-4600-7800 Series Backup

These lamps feature a lens and reflector that are sealed eliminating problems associated with moisture and dust infiltration. Available in LED as a supplemental lamp.

- Sealed lens and reflector
- Available in panel or chrome flange mount
- Low amp draw for LED

Order Nos.	Description	Amp Draw 12V	CTN
3841-0000-30	3"X7" panel mount, #1156 bulb, clear	2.1	6
3842-0000-30	3"X7" bezel mount, #1156 bulb, clear	2.1	6
3871-8000-30	3"X7" LED, panel mount, auxilliary backup	0.62	6
3872-8000-30	3"X7" LED, bezel mount, auxilliary backup	0.62	6
4641-0000-30	4"X6" panel mount, #1156 bulb, clear	2.1	6
4642-0000-30	4"X6" bezel mount, #1156 bulb, clear	2.1	6
4671-8000-30	4"X6" LED, panel mount, auxilliary backup	0.62	6
4672-8000-30	4"X6" LED, bezel mount, auxilliary backup	0.62	6
7841-0000-30	7"x9" panel mount, #1156 bulb, clear	2.1	6
7842-0000-30	7"x9" bezel mount, #1156 bulb, clear	2.1	6



3841-0000-30



4641-0000-30

## Service Parts For 3800, 4600 Backup

Order Nos.	Service Parts for 3800, 4600, 7800 Backup	CTN
0C90-0350-33	Repl. lens/refl assy, 4600	6
0C90-1028-33	Repl. lens/refl assy, 3800	6
0D30-0377-00	Repl. mounting pad, 4600 series, bezel mount	6
0D30-0385-00	Repl. mounting pad, 4600 series, panel mount	6
0D30-1026-00	Repl. mounting pad for 3800 series, bezel mount	6
0D30-1027-00	Mounting pad for 3800 series, panel mount	6
0K90-0336-00	Repl. socket, single contact	10
9018-0013-00	Repl. bulb: #1156, 32cp	100

## 9186-4500 Series, 3.875" Backup

This lamp can be used as a backup or utility lamp.

- Polycarbonate lens
- Black ABS trim ring

Order Nos.	Description	Amp Draw 12V	CTN
9186-4570-30	Black bezel, 1 wire, #1156 bulb	2.1	100
9186-4571-30	Black bezel, 2 wire, #1076 bulb	1.8	100
9018-0013-00	Repl. bulb, #1156, 32cp		100
9018-0025-00	Repl. bulb, #1076, 32cp		100



9186-4570-30

## 9186-5000 Series, 4" Backup

These 4" backup lights are fully sealed to prevent dirt and moisture infiltration. The 9186-5515 flange mount secures the lamp to the vehicle and a MPI150 connector provides a quick connection. The kit includes the lamp, mounting grommet and plug.

- Polycarbonate lens
- Sealed lamp
- "Sure seal" connector

Order Nos.	Description	Amp Draw 12V	CTN
9186-5301KC	4" backup, clear, incand, grommet mount w/ metripack con	2.1	50
9186-5515-31	4" backup, clear LED, flange mount, w/metripack con	.34	50
4040-0109-30	4" backup, clear LED grommet mount	.29	50



9186-5300KC



4040-0109-30



9186-5515-31

## 9186-8560 Series, Turn / Marker, 2.91" X 3.69"

Available in LED. Functions as a side turn indicator\* or marker light.

- Stainless steel housing
- No rust or corrosion issues
- Durable polycarbonate lens

Order Nos.	Description	Amp Draw 12V	CTN
9186-8580-29	LED turn/marker, amber	0.1/0.4	24
9186-8560-29	Marker w/ground tab, #1157 bulb, amber	.59/2.1	24
9186-8589-24	LED amber side turn/mrkr custom leads	0.1/0.4	24
0C12-1181-00	Repl. lens, polycarbonate, amber		12
0D10-1176-00	Repl. gasket, lens		12
0D30-1092-00	Repl. mounting pad		12
9018-0020-00	Repl. bulb: #1157, 32/3cp		100

\*no current DOT requirement for side turn



9186-8560-29

## 2710 Series, LED Side Turn / Marker, 6" x 2.65"

This lamp features eleven high-brightness LED's to provide an effective signal. The inner lens optics direct most of the light rearward into the vehicle blind spot area. The acrylic lens and base are vibration welded to achieve a water-tight seal. All electronic components are potted for added protection. The lamp uses a sealed connector to enable a reliable interconnect between the lamp and the vehicle. Metal bushings are inserted at the mounting points for added durability. Standard equipment on Navistar ProStar®.

- Excellent blind spot signal coverage
- Sealed lens/housing with potted electronics
- Metal bushings at mounting points

Order Nos.	Description	AMP Draw	CTN
2710-0100-20	Amber LED Turn/Marker, Amber Lens	.13/.05	50
2710-1100-20	Amber LED Turn/Marker, Clear Lens	.13/.05	50
0K90-2869-00	Plug Assembly, 3-Wire		10
0D10-2753-00	Mounting Pad		12



2710-0100-20



2710-1100-20





### 5150 / 5180 Series, Marker, 1.5" X 3.5", PC Rated

These lamps feature a tough acrylic lens with a built-in shield for added durability. The LED lamp provides reliable, long-life service. Both lamps meet combination clearance and marker functions.

- Built-in shield
- Armored metal shield available separately
- Low amp draw

Order Nos.	Description	Amp Draw	CTN
5150-0100-10	Marker, incandescent w/plug, red	0.35	100
5150-0100-20	Marker, incandescent w/plug, amber	0.35	100
5180-0100-10	Marker, LED, no plug, red	0.04	100
5180-0100-20	Marker, LED, no plug, amber	0.04	100
5180-0110-10	Marker, LED w/plug, red	0.04	100
5180-0110-20	Marker, LED w/plug, amber	0.04	100
OJ10-2161-BK	Shield for 5150/5180, powder coat black		50
OJ10-2161-GY	Shield for 5150/5180, powder coat grey		50
OK90-1601-00	Socket wedge base, w/delphi for 5150		10
OK90-1803-00	Plug assm, 2 wire, for 5180 lamp		10
OD10-1630-00	Replacement mounting pad		12
9018-0012-00	Replacement bulb #168		100



5150-0000-10



5180-0100-20  
Shown with optional guard (OJ10-2161-BK)



5180-0100-10  
Shown with optional Shield (OJ10-2161-GY)



5180-0100-10  
Shown with OK90-1803-00 Plug Assembly





## 5213 Series, LED Marker Lights NEW

These new 5213 LED marker lamps replace the previous 5210/5211 series. New features include universal mounting orientation and an integral sealed connector. The 5213 series marker lamps meet DOT requirements for combined clearance and side marker functions (PC rating). The lamps mount in a 19mm hole and do not require any additional fasteners. The integral connector accepts Molex connector 34900-2120, or use with Weldon plug assembly OK90-3717-00.

Order Nos.	Description	12 V Amp.	CTN
5213-0100-10	LED clearance/marker, red	0.04	100
5213-0100-20	LED clearance/marker, amber	0.03	100
OK90-3717-00	Plug assm, 2 wire, for 5213 lamp		100



5213-0100-10



5213-0100-20

## 9186-1500 Series, 1.1" X 2.59" LED Marker Lamp

These lamps utilize LED technology for unsurpassed life and reliability. Two lead wires exit for isolated ground or chassis connection. Use the OJ10-1200 brush guard for added durability.

- Low amp draw
- Sonic-welded base and lens
- Offered in a variety of colors
- Stainless brush guard available

Order Nos.	Description	Amp Draw 12V	CTN
9186-1500-10	LED clearance/marker, red	0.05	48
9186-1500-20	LED clearance/marker, amber	0.05	48
9186-1501-30	LED utility, clear	0.05	48
9186-1501-40	LED utility, blue	0.05	48
9186-1501-50	LED utility, green	0.05	48
OJ10-1200-00	Brush guard, stainless steel	-	48
OD10-1208-00	Mounting pad for brush guard	-	48
OD10-1530-00	Repl. mounting pad	-	48



9186-1501-30



9186-1500-20



9186-1500-10

 OJ10-1200-00  
Brush Guard

## 8101/8102 Series, Miniature License Illuminator

This surface mount lamp features a tough housing and lens for a long life. Available in LED and incandescent.

- Miniature, only 2.8" wide & 2" high
- Tough housing and lens

Order Nos.	Description	Amp Draw 12V	CTN
8101-0100-30	License lamp, #168 bulb, 3 CP w/delphi conn	0.35	100
8102-0100-30	LED licence lamp w/delphi conn	0.1	100
9018-0032-00	Repl. bulb, #168, 3CP		100



8101-0100-30



8102-0100-30



## 8080 / 8081 Series 8.02" x 4.1" LED Cab Dome Light

This standard cab dome light is available in incandescent and LED. Available in black or grey bezel, and in +Battery (-8000) for multiplexed systems, or Ground (-7000) switching configurations.

- Black (8080) or grey (8081) bezel
- +Battery (-8000) or ground (-7000) switching configurations
- Meets NFPA Illumination

Order Nos.	Description	Amp Draw 12V	CTN
8080-0000-13	Dual dome, bulb, ground switched, black bezel, red/clear	2/4	10
8080-1000-13	Dual dome, bulb, +batt switched, black bezel, red/clear	2/4	10
8080-7900-13	Dual dome, LED, ground switched, black bezel, red/clear, 4-wire	0.4/0.8	10
8080-8900-13	Dual dome, LED, +batt switched, black bezel, red/clear, 4-wire	0.4/0.8	10
8081-0000-13	Dual dome, bulb, ground switched, grey bezel, red/clear	2/4	10
8081-1000-13	Dual dome, bulb, +batt switched, grey bezel, red/clear	2/4	10
8081-7900-13	Dual dome, LED, ground switched, grey bezel, red/clear, 4-wire	0.4/0.8	10
8081-8900-13	Dual dome, LED, +batt switched, grey bezel, red/clear, 4-wire	0.4/0.8	10
OC10-2228-10	Lens, 8080/8081 series, red		12
OC10-2228-30	Lens, 8080/8081 series, clear		12
OC10-2228-40	Lens, 8080/8081 series, blue		12



8081-7900-13



8080-7900-13

## 8086 Series 9.65" x 4.81", Red/Clear Interior Lamp, Euro-Style On / Off Switch

With the same concept as the 8080/8081 series, this lamp features euro-style buttons.

- Black bezel
- Off-the-shelf bulb
- Blue lens available

Order Nos.	Description	Amp Draw 12V	CTN
8086-6978-68	Dome, w/push buttons, red/clear lens, #922 bulb	0.98/1.96	10
OC11-1223-00	Replacement lens, red		12
OC13-1225-00	Replacement lens, clear		12
OC14-1226-00	Replacement lens, blue		12
OE13-1878-00	Replacement bulb: #922, incandescent, 15 CP		100



8086-6978-68

## 8052 Series, 8" LED Recessed Low Profile Interior Dome Lamp

The 8052 Series is an ultra slim LED lamp with a low profile design with integrated cooling fins. Extending less than  $\frac{3}{16}$ " (4.8mm) below the headliner, the 8052 series frees up headroom space. The cast housing design improves cooling performance providing additional light, excellent lumen stability, and longer operational life. With 1000 lumens, this lamp delivers light evenly and consistently throughout the entire working space.

The 8052 series incorporates many features placing it at the top of its class. This lamp is designed around lighting the entire working area efficiently and consistently, giving EMTs the exact light they need.

- Excellent for illumination throughout the working area; including cot, floor, and compartments
- The low profile shape moves the LEDs closer to the lens surface to provide increased lighting of upper compartments
- High and low brightness or Pulse Width Modulation (PWM) operation to dim light from high setting
- 4100k color temperature which closely mimics daylight for excellent rendering of skin tones
- Diffused lens for "soft" illuminated appearance
- Ultra low profile, flush mount design; minimum protrusion ( $\frac{3}{16}$ " or 4.8 mm) into working area
- Slim pan depth ( $\frac{11}{16}$ " or 17.5 mm) allows for more room to run wires, insulation, etc. in the headliner
- Rugged die cast aluminum construction; built-for-life
- Die cast housing with unique styled heat-sinking keeps LEDs running cooler which equals brighter and longer life
- Meets GSA-KKK and NFPA 1917 standards for illuminations
- 5 year warranty
- Built on the same platform and a family product with the 8051 ultra-bright 1000 lumen dome lamp
- 12V only



8052-0000-30

Order Nos.	Description	Amp Draw 12V	Amp Draw 24	CTN
8052-0000-30	Recessed Low Profile Interior Dome Lamp	1.5	.62	20
0C20-3179-00	Replacement lens for 8052			70

## 8" Recessed Interior Dome Lamp

Available in patented V-LED technology, Incandescent or Halogen, the 8" LED Interior Dome Lamp minimizes heat and vibration issues, and requires less current draw. This LED dome lamp features patented V-LED technology for optimal light output. LED's are serviceable, allowing the lamp to be upgraded as LED technology progresses. Light output is 750 lumens while consuming only 10 watts of power. A new deeper housing provides a completely flush mounted lamp. Surface mount version also available.

### 8040 Series:

- Meets GSA-KKK specifications when installed properly
- Single or Hi/Low operation

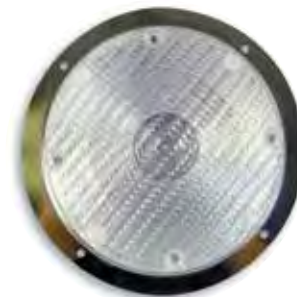

8046-0320-80

Order Nos.	Description	Amp Draw 12V	CTN
8046-0300-80	Recessed mount, single bulb #gh9, ss body, clear lexan lens	2.9	32
8046-0320-80	Recessed mount, hi/lo, #gh9/#906, ss body, clear lexan lens	2.9/.69	32
9018-0034-00	Replacement bulb, #gh9 halogen 37.5w for 8046 series		100
9018-0035-00	Replacement bulb, lo, #906, 6cp for 8046-0320-80		100
1003-0000-80	Replacement lexan lens for 8040/8046, clear		12

## ON80-2485 Series, PWM Converter, 2 Channel

This module eliminates the flicker that is sometimes associated with PWM dimming of LED dome lamps. The module has two channels and can supply up to 10 amps per channel. Maximum output for both channels combined is 15 amps.

- Can be used with 8000 Series LED dome lamps

Order Nos.	Description	CTN
ON80-2485-00	PWM Converter, 2 Channel	1
OK90-3448-00	Connector Kit for PWM Converter	1



ON80-2485-00



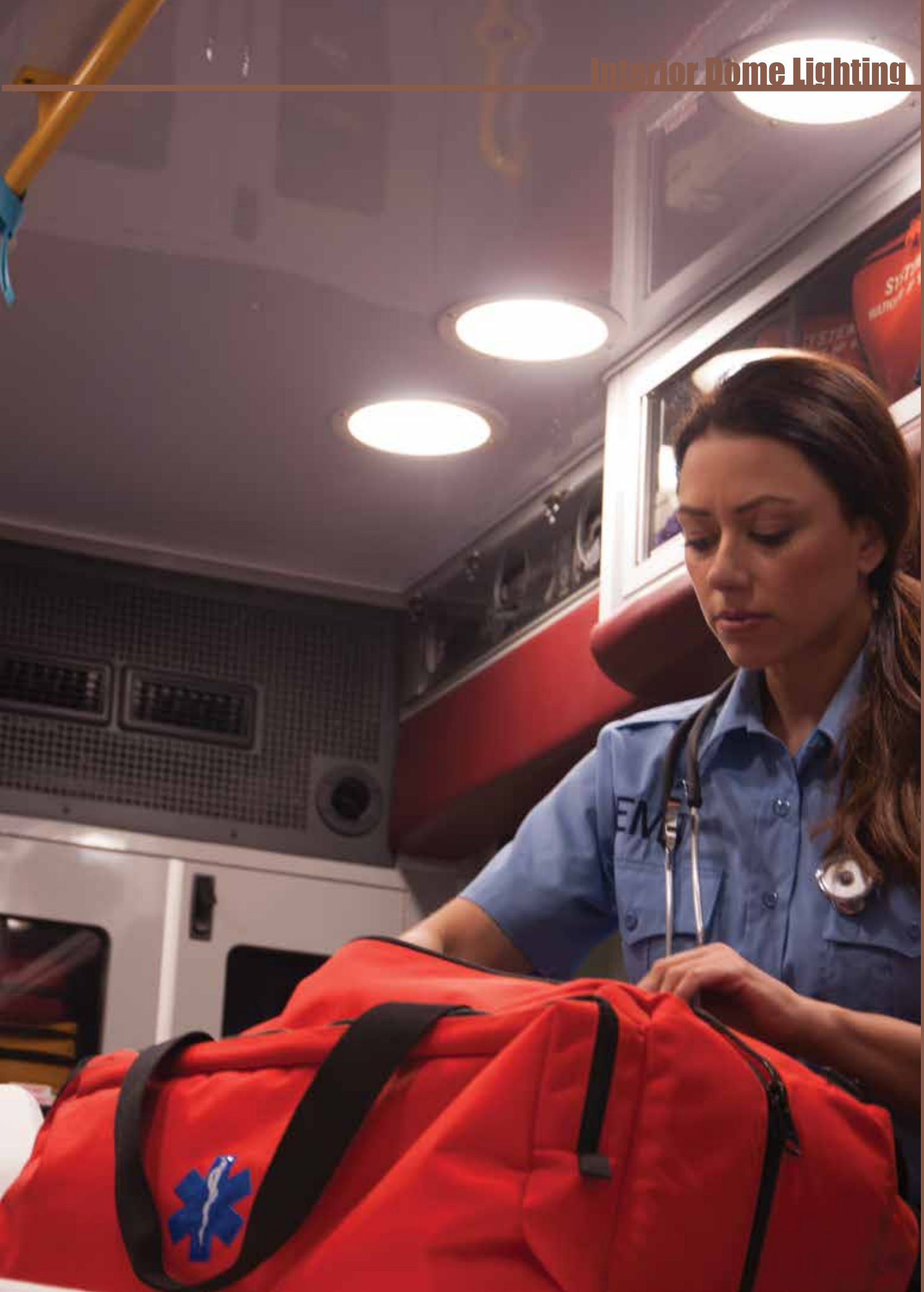

## V26S / V34S Diamondback V-LED Utility Lamps

With all the same features as our Diamondback Scene Lamps, the V26S and V34S are available for use as compartment, stepwell, boarding, and area lighting lamps. These lamps are surface mounted, and fully upgradable/serviceable.

- High optical efficiency maximizes illumination with minimum current draw
- High precision optical elements direct lighting onto work surfaces which minimizes scatter
- High impact polycarbonate lens with anti-scratch hard coating
- Integral mounting pad
- Optional chrome plated bezels with molded mounting pads
- 5 year warranty

Order Nos.	Description	Amp Draw 12V	Amp Draw 24V	CTN
V26S	2x6 DB Utility lamp	.46	.23	1
V34S	3x4 DB Utility lamp	.46	.23	1
V34S-9009	3x4 DB Utility lamp w/Delphi connector	.46	.23	1
OC20-2408-30	2x6 Cover Lens, Clear			1
OC20-2191-30	3x4 Cover Lens, Clear			1
OB80-2495-00	Bezel Kit, 2X6 Diamondback			1
OB80-2334-00	Bezel Kit, 3x4 Diamondback			1

See page 134 for Diamondback 3x7, 4x6, and 7x9 Scene Lamps.



V34S



V26S

## 2630 / 2631 Series Dome/Pump Panel Lamp

The 2630 and 2631 lamps can be used as a dome or in pump panel applications directly replacing the 2030 series lamps. The LED version features a slim profile allowing for improved clearance and lowered amperage current draw. Both lamps are all plastic construction and fully sealed to prevent moisture, dirt and corrosion issues.

- Directly replaces current 2030 series pump panel and compartment lamps
- Fully sealed, surface mount with foam mounting pad
- 2630 - 21 CP incandescent – 1.44 Amp draw
- 2631 – 6 CP 20 LEDs - 0.3 amp draw
- 2631 – slim profile (.78" thick)
- Measures 2.5"x6"

Order Nos.	Description	Amp Draw 12V	CTN
2630-0000-30	Incandescent sealed lamp	1.44	24
2631-0000-30	LED sealed lamp	0.3	24



2631-0000-30



2630-0000-30

## 8270-0100-30 LED Work Lamp

This OEM approved LED work lamp features four mid-power LED's, providing 120 lumens of brilliant white light. The engineered optics focus the light downward onto the work area. Lamp mounting points include nickel plated brass bushings to provide durable installation to the vehicle. Lens and base are vibration welded and electronics are potted to ensure years of worry-free service. Lamp fits standard 4" round flange mount applications - great for heavy truck hook-up work areas. Also works great as a bus loading lamp around entry/exit doors. 12V Only. Standard equipment on Navistar ProStar®.

Order Nos.	Description	Amp Draw 12V	CTN
8270-0100-30	LED Work Lamp	.18	50
OK90-3101-00	2 wire plug		12



8270-0100-30



## 9185 Series, 4" Utility Lamps

This recessed mount lamp series can be used as a compartment or an underbody lamp. The 9185-40034 series features epoxy-sealed terminals and can be used for underbody applications. An aluminum bracket is available separately for underbody illumination.

Order Nos.	Description	Amp Draw 12V	CTN
9185-40003-3	Utility/grommet kit, clear	1.4	50
9185-40034	Utility kit, clear	1.4	50
0J10-0503-00	Mounting bracket for underbody application, 9185-40003		48



9185-40003-3



0J10-0503-00

## 9186 Series, Stepwell Lamp

- Your choice of 21, 32, 50 candlepower
- Molded mounting pad provides an excellent seal
- Stainless construction, no corrosion issues

Order Nos.	Description	Amp Draw 12V	CTN
9186-8562-30	Stepwell, 32CP, #1156 bulb, clear	2.1	24
9186-8563-30	Stepwell, 32CP, #1156 bulb, w/ground wire, clear	2.1	24
9186-8563-34	Stepwell, 32CP, #1638 bulb, w/ground wire - 24v	1.0	24
9186-8564-30	Stepwell, 21CP, #1141 bulb, clear	1.4	24
9186-8565-30	Stepwell, 21CP, #1141 bulb, w/ground wire, clear	1.4	24
9186-8566-30	Stepwell, 50CP, #1195 bulb, clear	3.0	12
0C63-1180-00	Repl. lens, glass, clear		12
0D10-1176-00	Repl. gasket, lens		12
0D30-1092-00	Repl. mounting pad		100
9018-0013-00	Repl. bulb: #1156, 32CP		100
9018-0019-00	Repl. bulb: #1141, 21CP		100
9018-0051-00	Repl. bulb: #1638, dc 32CP		100



9186-8563-30

## 9186 Series, License Illuminator / Stepwell

This lamp can be used in a license or stepwell application.

- Corrosion resistant
- Die cast zinc housing and ABS base
- Twist-lock socket for easy bulb service
- Available with isolated ground for non metallic surface mounting

Order Nos.	Description	Amp Draw 12V	CTN
9186-23882-30	Stepwell & utility, #906 bulb, clear	0.69	100
0J10-0393-00	Bracket, black		10
9018-0035-00	Repl. bulb, #906 WB 6CP		100
9186-23882-2540	Repl. mounting pad		12



9186-23882-30



0J10-0393-00

## LED Courtesy Lamps

Small In Size, Large In Light Output. These miniature LEDs are available in amber, blue, clear, green and red. These weatherproof LEDs are potted in epoxy for added durability. Lamp measures only 1.13" x .75"

- Your choice of chrome or black body
- Excellent for water level indicator
- Low amp draw

Order Nos.	Description	Amp Draw	CTN
9186-2300-xx	LED courtesy, black	0.025	12
9186-2301-xx	LED courtesy, chrome	0.025	12

Note: xx Denote (-10 red), (-20 amber), (-30 clear), (-40 blue), (-50 green)



9186-2300-10



9186-2300-30



## 8220 Series, LED Cab Dome Lamp

Truck OEM qualified LED interior dome lamp. Lamp exceeds SAE and abusive heavy-truck performance and durability requirements. Lamp is designed to illuminate cab interior with broad illumination pattern and consistent color temperature. Snap-in design and integral connector plug provide rapid installation to headliner and clean look with no visible fasteners.

- Lamp utilizes six white mid-power LEDs, providing 220 lumens of effective illumination
- Automotive-grade LEDs are used to provide life of the vehicle service
- Custom engineered lens system directs light efficiently while providing an aesthetically pleasing appearance
- Integral connector provides reliable interconnect with vehicle harness
- Snap-in mounting design eliminates the need for unsightly fasteners



8220-4100-30

Order Nos.	Description	Amp Draw 12V	CTN
8220-4100-30	LED Cab Dome Lamp, Graystone	0.3	50
OK90-3442-00	Plug Assembly, 3-Wire		1

## 8240 Series, LED Cab Dome Lamp with Switch

Truck OEM qualified LED interior dome lamp. Lamp exceeds SAE and abusive heavy-truck performance and durability requirements. Lamp is designed to illuminate cab interior with broad illumination pattern and consistent color temperature. Snap-in design and integral connector plug provide rapid installation to headliner and clean look with no visible fasteners.

- Lamp utilizes four white mid-power LEDs, providing 145 lumens of effective illumination
- Automotive-grade LEDs are used to provide life of the vehicle service
- Lamp is operated by push-button switch in the lens or by a remote switch in the vehicle
- Integral connector provides reliable interconnect with vehicle harness
- Snap-in mounting design eliminates the need for unsightly fasteners



8240-2100-30

Order Nos.	Description	Amp Draw 12V	CTN
8240-2101-30	LED Cab Dome Lamp with Switch, Dark Neutral	0.2	50

## 8280 Series, LED Accent Lamp with Switch Control

Truck OEM qualified LED compartment lamp. Lamp exceeds SAE and abusive heavy-truck performance and durability requirements. Lamp is designed for interior cabinet/compartment illumination with broad illumination pattern and consistent color temperature. User can control lamp operation by pressing lens. Snap-in design and integral connector plug provide rapid installation and clean look with no visible fasteners.

- Lamp utilizes two white mid-power LEDs, providing 70 lumens of effective illumination
- Automotive-grade LEDs are used to provide life of the vehicle service
- Lamp is operated by push-button switch in the lens or by a remote switch in the vehicle
- Integral connector provides reliable interconnect with vehicle harness
- Snap-in mounting design eliminates the need for unsightly fasteners



8280-4110-30

Order Nos.	Description	Amp Draw 12V	CTN
8280-4111-30	LED Accent Lamp with Switch, Graystone	0.1	50
OK90-3442-00	Plug Assembly, 3-Wire		1

## 8250 Series, LED Swivel Reading Lamp

This lamp features two mid-power white LED's to provide 100 lumens of light output. The convex lens optic efficiently focuses the light onto the target reading surface. The lighthouse swivels, allowing the user to position the light beam toward the desired location. The lamp features a prominent ON/OFF switch for easy activation in low-light conditions. The lamp has an integral connector to enable a reliable connection to the vehicle harness.

- 100 lumen total light output
- Adjustable swivel lighthouse
- Prominent ON/OFF switch
- 12V operation



8250-4100-30

8250-5100-30

Order Nos.	Description	Amp Draw 12V	CTN
8250-4101-30	LED Swivel Reading Lamp, Graystone	.1	24
8250-5101-30	LED Swivel Reading Lamp, Black	.1	24
OK90-3187-00	Plug Assembly, 2-Wire		1



## HID Scene Lighting

- Generates truer, daylight illumination
- 250 Candle Power – 3200 Lumens
- Instant restrike
- Consumes 33% less power than halogen (35w HID vs. 50w halogen)
- Rated at 3,000 hours of service
- Bulb is serviceable
- Ballast and interconnects included
- Designed for 12v applications

Order Nos.	Description	Amp Draw 12V	CTN
3862-0000-33	3" X 7" HID scene, bezel mount, clear	2.6*	2
4662-0000-33	4" X 6" HID scene, bezel mount, clear	2.6*	2
7862-0000-33	7" X 9" HID scene, bezel mount, clear	2.6*	2
0E93-1571-00	Repl. bulb/adaptor assy		1
0N00-1471-00	HID Ballast		1
0L40-1472-00	Harness		1
0D00-1569-00	HID Spacer 3800		1
0D00-1570-00	HID Spacer 4600		1
0D00-1458-00	HID Spacer 7800		1

\*after bulb warm up



3862-0000-33



4662-0000-33



7862-0000-33

## 3800, 4600, 7800 Series Halogen Scene Lamps

Weldon's Halogen Scene lights feature a combination of 15 to 26 degree optics to effectively illuminate the work area. The lens and reflector are sealed eliminating the problems of dust and moisture infiltration.

Order Nos.	Description	Amp Draw 12 V	CTN
3811-0000-33	3" x 7" Halogen, #886, panel mount, clear	3.9	6
3812-0000-33	3" x 7" Halogen, #886, bezel mount, clear	3.9	6
4611-0000-33	4" x 6" Halogen, #886, panel mount, clear	3.9	6
4612-0000-33	4" x 6" Halogen, #886, bezel mount, clear	3.9	6
7811-0000-33	7" x 9" Halogen, #886, panel mount, clear	3.9	6
7812-0000-33	7" x 9" Halogen, #886, bezel mount, clear	3.9	6



3811-0000-33



4612-0000-33



7812-0000-33

Order Nos.	Service Parts for 3800, 4600, 7800 Series & HID Scene Lamps	CTN
0C90-0350-33	Repl. lens/refl assy, clear, scene/backup, for 4600	6
0C90-1028-33	Repl. lens/refl assy, clear, scene/backup, for 3800	6
0C90-1138-33	Repl. lens/refl assy, sf-scene, for 7800	6
0D30-0377-00	Repl. mounting pad, 4600, bezel	6
0D30-0385-00	Repl. mounting pad, 4600, panel	6
0D30-1026-00	Repl. mounting pad, 3800, bezel	6
0D30-1027-00	Repl. mounting pad, 3800, panel	6
0D30-1136-00	Repl. mounting pad, 7800, bezel	6
0D30-1137-00	Repl. mounting pad, 7800, panel	6
0E22-1357-00	Repl. bulb: #886, halogen, right angle base, 100 cp @ 12.8 v, 3.9a	100
0K90-1806-00	Scene lamp socket/harness kit, 886 bulb	10
0D10-1025-00	Repl. gasket between lamp/bezel 3800	6
0D10-0334-00	Repl. gasket between lamp/bezel 4600	6
0D10-1035-00	Repl. gasket between lamp/bezel 7800	6
0B53-1016-00	Bezel 3"x7"	
0B53-0333-00	Bezel 4"x6"	
0B53-1125-00	bezel 7"x9"	

## Diamondback™ LED Scene Lamp

To provide a seamless look across your apparatus, use the Diamondback LED scene lamp in conjunction with your Diamondback LED warning lamps. Unlike other LED scene lamps the Diamondback LED scene lamp is surface mounted. No large body cut outs required.

- Patented Diamondback styling to complement warning lamps
- Very high optical efficiency maximizes illumination with minimum current draw
- High precision optical elements direct lighting onto work surfaces which minimizes scatter
- Efficient electronic regulation reduces current draw and maintains LED intensity throughout the lamps operating voltage range of 11-32V (intensity may diminish below 11V input)
- Eight (8) element lamps operate at 12W (1A), Sixteen (16) element lamps operates at 24W (2A)
- Like all Diamondback products, these scene lamps offer:
  - 5 year warranty
  - High-impact polycarbonate lens with anti-scratch hardcoating
  - V-LED devices to maximize thermal and optical performance
  - Fully upgradable/serviceable components
  - Integral mounting pad
  - Optional chrome plated bezels with molded mounting pads
  - V79S light output of 1200 lumens



V375



V46S



V79S

Order Nos.	Description	Amp Draw 12V	Amp Draw 24V	CTN
V375	Diamondback LED scene, 3X7, 8 element	.92	.45	1
V46S	Diamondback LED scene, 4X6, 8 element	.92	.45	1
V79S	Diamondback LED scene, 7X9, 16 element	1.84	.96	1

Bezel kits available separately

### Bezel Kits Part Numbers

Order Nos.	Description	CTN
0B80-2335-00	Chrome bezel kit for 3"X7" Diamondback	1
0B80-2336-00	Chrome bezel kit for 4"X6" Diamondback	1
0B80-2337-00	Chrome bezel kit for 7"X9" Diamondback	1
0C20-2170-30	V37 replacement cover lens, clear	1
0C20-2177-30	V46 replacement cover lens, clear	1
0C20-2184-30	V79 replacement cover lens, clear	1

3x4 and 2x6 V-LED Utility lamps are also available. See page 130.



V26S



V34S







**Revel Scout Tactical LED Work Light**

**ELRE-SCOUT**

This tactical LED scene light is designed to increase the safety of both firefighters and emergency responders. With versatile mounting options – set, hang, strap, spike – and a removable, rechargeable battery, the Revel Scout revolutionizes the operational ease of scene lighting.

**Light Where You Need It:**

Powered by a removable, rechargeable battery, the Revel Scout is all you need to light both your entire exterior scene and interior work area. Easy to move or position, the Revel Scout's combination of flood and spot light optics increases your overall scene visibility when lighting exterior spaces such as vehicles, structures, parking lots and overhead hazards. It can then be used to continue your work inside for overhaul and other tasks.

Light Performance	High	Medium	Low	Spot
	Light Output (Lumens)	14,000	8,000	2,000
Average Run Time (Hours)*	1.2	3	7	3.5

\* Run time varies depending on environmental conditions and other factors



Battery Charger  
12/24V DC, 120V AC, or 240V AC



Rechargeable  
LI-ION Battery



Optional  
Mounting Bracket



Optional  
Storage Case

**Fast, Flexible Deployment**



Spike into Drywall



Strap and Secure



Hang Over a Door

Style	Lamp Type	Battery Type	Battery Charge Time	Weight (Light + Battery)	Battery Weight	Overall Dimensions	IP rating	Warranty
ELRE-SCOUT	LED	28V LI-ION	1 hr	12 lbs (5.4 kg)	3 lbs (1.4 kg)	13.25" L x 11.5" W x 11" H (337 x 292 x 279 mm)	IP66	Battery and charger: 1 YEAR Light assembly: 6 YEAR

For ordering instructions and accessories visit [akronbrass.com](http://akronbrass.com)

## Revel® LED Scene Light

### ELRE-SLDC and ELRE-XLDC

Turn any dark, hazardous situation into daylight with the Revel, Akron's high powered LED scene light. The Revel combines a spot and flood pattern into one powerful 14,000 or 28,000 lumen solution. Direct light evenly across your entire scene with the Revel's enhanced pattern design.

- Combination spot/flood optics
- True surface mount 14,000 and 28,000 lumens
- Push button swivel for simplified, efficient operation
- IP 67 rated

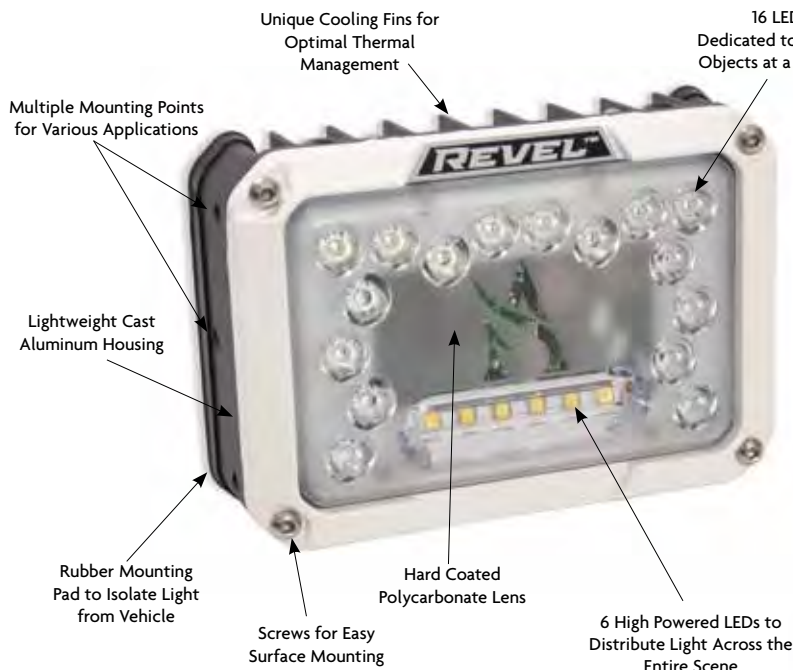

ELRE-SLDC-SF  
14,000 Lumens

High Impact, UV Resistant Handle



ELRE-XLDC  
28,000 lumens

Push Button Release for Tilt Adjustment



Available In Surface, Brow or Pole Configurations (Custom Mounts Available)

### Powerful Performance

#### Optic Superiority

Bursting with 14,000 or 28,000 lumens, the Revel is all you need to light your entire scene. The patent-pending combination of spot and flood performance increases your overall scene visibility when lighting your exterior spaces such as vehicles, structures, parking lots and overhead hazards.

#### Flexible Mounting Options

Available as a true surface mount, the Revel can be easily installed in any location on your truck. Other vehicle mounted configurations include: brow, swivel base, pedestal, push-up, pull-up, air operated, and manual mast.

#### Simplified Operation

The unique, push button swivel makes adjusting and redirecting your light simple with a gloved hand.

Light Head	Wattage	Voltage	Amps	Lumens	Dimensions (surface)			Dimensions (pole)		
					Height	Width	Depth	Height	Width	Depth
ELRE-SLDC	110	10-32 DC	9.1	14,000	5.25" (133 mm)	7.5" (191 mm)	2.0" (51 mm)	5.25" (133 mm)	7.5" (191 mm)	3.73" (95 mm)
ELRE-XLDC	220	10-32 DC	18.2	28,000	5.25" (133 mm)	13.75" (349 mm)	2.0" (51 mm)	5.25" (133 mm)	13.75" (349 mm)	3.73" (95 mm)



## SceneStar® LED Scene Light

### ELSS-SLDC, XLDC and ELSS-XLAC

Operating in the dark is difficult and dangerous. Scene lighting is essential for night operations and helps emergency responders spot hazards, creating safe work environments. Akron Brass is committed to protecting those who protect us by presenting a complete line of LED scene lights.

Packed with high performance features, the SceneStar is designed to meet your lighting needs. From generator light kits to apparatus mounted lights to cord reel lights, Akron Brass delivers the most options for your lighting solutions.



High Impact, UV resistant  
Handles & Heat Sink Cover

48 Ultra Bright LEDs  
Delivering a Powerful  
20,000 Lumens

Instant  
On/Off

Dual Ergonomic  
Handles for Easy Light  
Head Positioning

Tempered Glass





ELSS-XLAC-PL







Akron Brass Extenda-Lite Scene Lights are designed to withstand the rigors demanded by the fire service, providing superior lighting in every situation. Akron's lights are manufactured using the highest quality materials and workmanship.

### LED

	Light Head	Bulb Type	Wattage	Voltage	Amps	Lumens	Certifications	Light Head Dimensions	Weight
	ELSS-SLDC	LED	150	10-32 V DC	12 (12 V DC) 6 (24 V DC)	14,000	CE RoHS	14" W x 4 1/4" H x 5.6" D (356 x 108 x 142 mm)	10 lbs (4.5 kg)
	ELSS-XLDC	LED	220	10-32 V DC	18 (12 V DC) 9 (24 V DC)	19,000	RoHS		
	ELSS-XLAC	LED	220	120 AC	1.8	20,000	UL LISTED RoHS SR		
	ELSS-XLAC2	LED	220	240 AC	.9	20,000	CE RoHS		
	ELRE-SLDC	LED	110	10-32 DC	9.1	14,000	RoHS	7.5" W x 5.25" H x 2.0" D (191 x 133 x 51 mm)	3 lbs (1.4 kg)
	ELRE-XLDC	LED	220	10-32 DC	18.2	28,000	RoHS	13.75" W x 5.25" H x 2.0" D (349 x 133 x 51 mm)	6 lbs (2.8 kg)

### Halogen

Light Head Description	Light Head	Bulb Type	Wattage	Voltage	Amps	Lumens	Certifications	Light Head Dimensions	Available Options
	ELBE-500	Quartz Halogen	500	120 AC	4.5/2.3	10,500		13.75"W x 4"H x 3.5"D (350 x 101 x 89 mm)	SW
	ELBE-750	Quartz Halogen	750	120 AC	7	21,000			
	ELST-500	Quartz Halogen	500	120 AC	4.5/2.3	10,500	CE UL	8.75"W x 8.5"H x 5.5"D (222 x 216 x 140 mm)	WG SW
	ELST-1000	Quartz Halogen	1000	120/240 AC	9/4.5	21,500	CE UL	16.5"W x 9.5"H x 5.5"D (420 x 241 x 140 mm)	WG SW
	ELST-1500	Quartz Halogen	1500	120/240 AC	13/6.3	35,000			

\*Highly Polished Specular Hammertone Reflector.

### Light Head Options:



**WG**  
Chrome Plated Wire Guard  
Available on ST Series only



**SW**  
Switch for Light Head (Includes rubber boot)  
Standard on Scenestar & Revel pole mounted lights

## Portable Base (PL)

Heavy-Duty Portable Lights designed to provide effective portable lighting where you need it.

- Superior powder coated aluminum construction
- Available with SceneStar®, ST Series and Beta light heads (Not recommended for use in 12V applications)
- UL listed with Stonco light heads
- Standard with prewired 12" pigtail and L5-15 (110V)\*
- Meets NFPA requirements
- Triangle base for added stability



PLMT - can mount a PL Light on its side or upside down



ELSS-XLAC-PL  
Portable light with SceneStar light head



ALL 110 & 220 Volt  
EXTENDA-LITES use  
2-Wire Plus Ground as  
Standard

### Mounting Options:



**PLMT**  
Portable Mounting Bracket



**POD-PL \*\***  
PL-Series Light mounted on the Extenda-POD

\* Specify plug if something other than standard plug is required

\*\* When ordering PL on tripod, PL-POLE-MT bracket must also be added

## Tripod (POD)

Heavy-duty tripods engineered for maximum stability and durability while providing fully adjustable scene lighting from 3'-11' in height.

- Available in 4 sizes, specify size in part number when ordering. See page 141
- Custom sizes not available
- Heavy-duty anodized aluminum poles & leg braces for extreme strength and durability
- Heavy-duty 1 1/4" anodized aluminum legs provide ultimate stability
- Twist lock for quick and easy height adjustment (Standard unless otherwise specified)
- Available with any Akron Brass light head (not recommended for use in 12V applications)
- Can be used as a pull-up light while mounted to truck
- Standard with pre-wired L5-15 (110V) plug on 110 AC versions



POD-PL  
PL-Series Light mounted on the Extenda-POD



E-4750-POD  
Extenda-POD with Beta light head

### Mounting Options:



**POD-Bracket**  
3 piece tripod mounting system



**POD-PL**  
PL-Series Light mounted on the Extenda-POD



**POD-Bracket-Long**  
3 piece tripod mounting system - long



**PRO**  
POD ring only

### Other Options:



**LC**  
Locking Collar



# Extenda-Lite® Tripod Dimensions

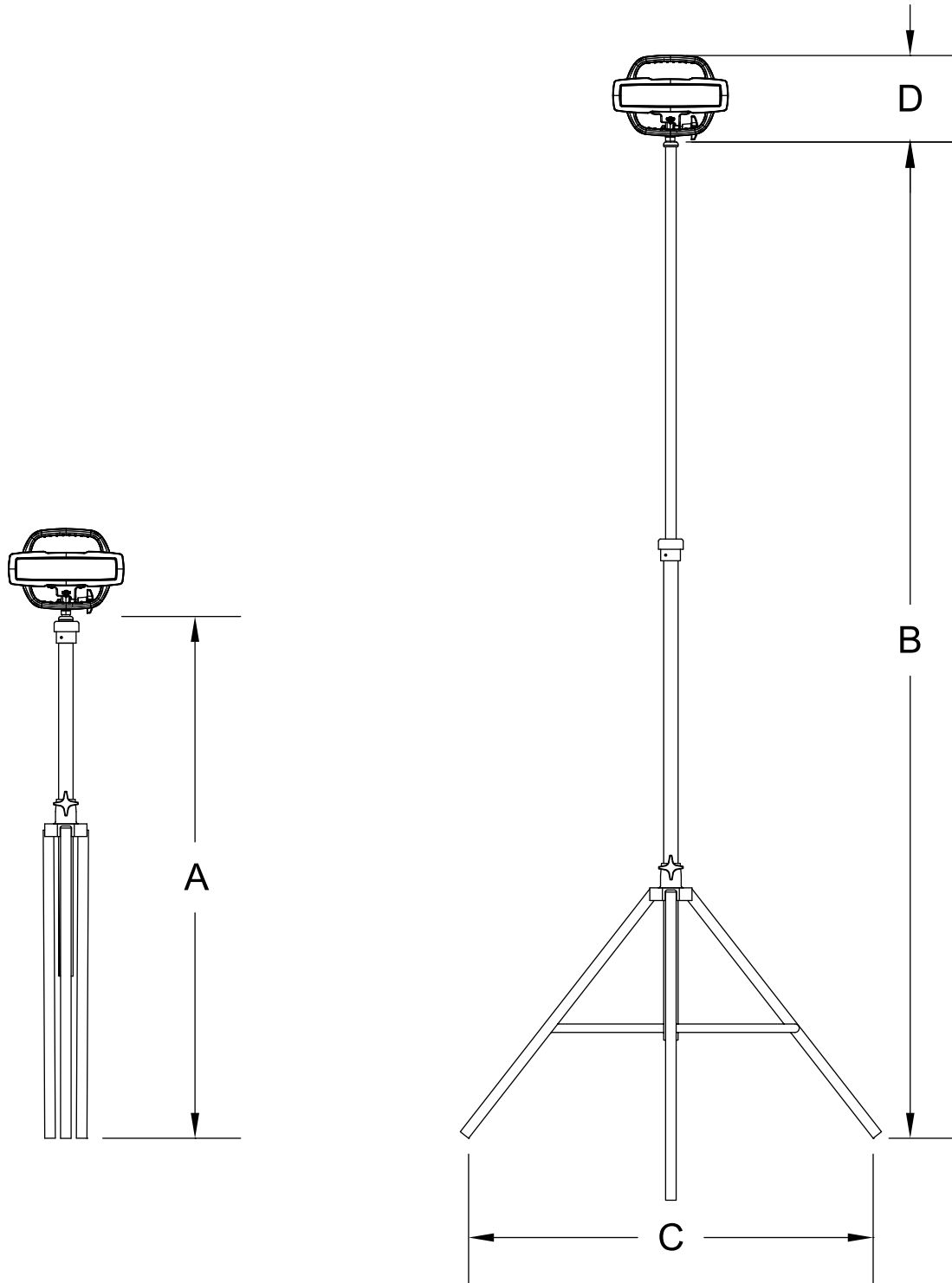

	POLE DIMENSIONS (mm)		
	A	B	C
T1	60" (1524 mm)	118" (2997.2 mm)	48" (1219.2 mm)
T4	52" (1320.8 mm)	96" (2438.4 mm)	48" (1219.2 mm)
T2	41" (1041.4 mm)	74" (1879.6 mm)	39" (990.6 mm)
T5	26" (660.4 mm)	43" (1092.2 mm)	22" (558.8 mm)

Light Head	Head Height
	D
Beta	9" (228.6 mm)
Stonco	12" (304.8 mm)
SceneStar	12" (304.8 mm)

## Extenda-Lite® Pull-Up (PU) & Push-Up (PS) Lights

- Fully adjustable telescoping poles
- Pull-up Styles are standard with 58" (1473.2 mm) outside poles and 48" (1219.2 mm) inside poles
- Push-up Styles are standard with 11.5" (292.1 mm) outside poles and 60" (1524 mm) inside poles
- Custom sizes available (additional charges apply)
- Heavy-duty anodized aluminum poles
- Twist Lock for quick and easy height adjustment
- Internal coil cord (standard)
- External coil cord available
- Powder coated mounting brackets
- Available with any Akron Brass light head



ELSS-XLDC-PU-SM  
Pull-Up with  
SceneStar head &  
SM-2 Side Mount  
mounting brackets

ELST-1500-PS-SM  
Push-Up Side Mount with  
Stonco light head & SM-2  
Side Mount mounting  
brackets

E-POLE-W-NB  
Pull-Up Pole with wiring (No light head)



E-PS-UP-W-SM2  
Push-Up Pole with wiring / side mount with optional  
SM-2 mounting brackets

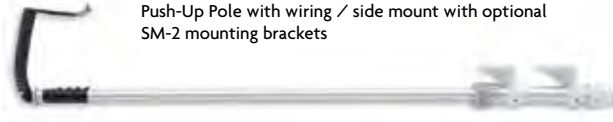

### Mounting Options:



**SM2**  
Side Mount  
Bracket 2 1/8"  
Offset



**SM4**  
Side Mount  
Bracket 4 1/4"  
Offset



**TM**  
Top Mount  
Bracket  
(For use  
with Pull-up)

**NB**  
No Bracket  
(Use this option  
if brackets are  
not required)

### Other Options:



**HC-4**  
Handle Cup for Push-Up  
Lights with 4 1/4" Offset



**HC-2SC**  
Handle Cup with  
Stop 2 1/8" Offset



**HC-4SC**  
Handle Cup with  
Stop 4 1/4" Offset



**WO**  
Wire Out the  
Top of the Pole



**UI**  
Up Indicator  
Switch



**SC**  
Stop Collar (2 Pieces)  
For Inside Pole

**SC-171**  
Stop Collar (2 pieces)  
for outside pole. Air  
operated only.



## Extenda-Lite Swiveling Bases (SB)

Akron Brass' non-telescoping swivel bases provide a permanently mounted scene light designed to rotate 350° while still allowing the light head to be tilted up or down.

- Hand knobs for quick and easy swivel adjustment
- Powder coated mounting brackets
- Available with any Akron Brass light head
- Rated for vertical mounting orientations only.



ELSS-SLDC-SB  
Swivel Base with  
SceneStar light head



## Manual Mast (MMST)

This collapsible pole assembly is designed to be folded away into the stored position. It will accept a variety of light heads. The Manual Mast has a footprint of just 7.5" by 42" and can be permanently mounted on a flat surface. With no internal space required for storage, this pole assembly will work anywhere side mounting or internal compartment mounting is not an option. Applications include roofs of utility vehicles or trailers, tops of skid units, or even mobile generator trailers.

- One person setup in less than a minute
- Collapsed height of 5.5"
- Various pole lengths available
- Made of the same durable materials you have come to expect from the Extenda-Lite line
- Standard with stow indicator, locking brackets, and no-mar stops
- Up indicator for pole extension not included



MMST (Pole only)



ELBE-500-MMST



## Extenda-Lite® Air Operated Poles (AO)

This pneumatically raised telescoping pole has been designed to operate off the apparatus' air system and provide effective scene lighting while keeping firefighters off the top of the apparatus.

- Light head can be manually rotated left and right and up and down for maximum adjustability
- Heavy-duty anodized aluminum poles
- Weatherproof control box with built-in air controls
- Pressure switch inside the control box turns on the light when raised
- Internally coiled cord
- Available with any Akron Brass light head
- Standard sizes are: 48 (Side Pole)/58 (outside) - 104" Extended length  
38 (Side Pole)/48 (outside) - 84" Extended length



AO-1  
Air Control Box



ELST-1500-AO-SM  
Includes Air control Box

### Mounting Options:

**SM2-LC**  
Side Mounting  
Bracket with lock.  
Holds any pole 2 1/8"  
away from body.  
Designed for use with  
Air Operated Poles

**TM-LC**  
Top Mounting  
Bracket with lock  
Designed for use  
with Air Operated  
Poles

**SM4-LC**  
Side Mounting Bracket  
with lock. Holds any pole  
4 1/4" away from body.  
Designed for use with Air  
Operated Poles

**SM2**  
Side Mount  
Bracket 2 1/8"  
Offset

**SM4**  
Side Mount  
Bracket 4 1/4"  
Offset

**TM**  
Top Mount  
Bracket

**NB**  
No Bracket  
(Use this option if brackets  
are not required)

## Brow Lights

Akron Brass' Brow lights are designed for compact apparatus perimeter lighting.

### ScenStar Brow Light (BL)

- Designed specifically to fit the profile of the cab
- Provide CAB information when ordering
- Available with SceneStar and Revel lights



ELSS-XLDC-BL  
19k SceneStar Brow Light



ELRE-SLDC-BL

## Recessed Lights

Akron Brass' Recessed lights are designed for compact apparatus perimeter lighting.

### Recessed Light (RM)

- Available with SceneStar lights
- Recessed within the apparatus body panel
- Mounts with less than 2" of depth



ELSS-SLAC-RM  
(15,000 lumens)



ELSS-SLDC-RM  
(14,000 lumens)

## Extenda-Lite Ordering Information

To order simply choose one from column **A** (Light Head, pages 137-139), one from column **B** (Mounting Type, pages 140-144)

Mounting brackets from column **C** (Mounting brackets, page 140-144) & any additional options from column **D** (Options, page 140-144)

Example 1: 500 watt Stonco light with Pull-Up Poles & 2" Side Mount Brackets and a Up Indicator

$$\begin{matrix} \text{ELST-500} & - & \text{PU} & - & \text{SM2} & - & \text{UI} & = & \text{ELST-500-PU-SM2-UI} \\ \text{A} & & \text{B} & & \text{C} & & \text{D} & & \end{matrix}$$

<b>A</b>		<b>B</b>		<b>C</b>		<b>D</b>	
Light Head*		Mounting Type		Mounting Brackets		Options	
ELST-500	ST Series	PL	Portable Light Base	SM2	2" Side Mount	HC-2	2" Handle Cup
ELST-1000	ST Series	PU-PL	Pull-Up with Portable	SM2-LC	2" Side Mount with lock	HC-2SC	2" Handle cup w/stop
ELST-1500	ST Series	PU	Pull-Up	SM4	4" Side Mount	HC-4	4" Handle Cup
ELBE-500	Beta	PS-PL	Push-Up with Portable	SM4-LC	4" Side Mount with lock	HC-4SC	4" Handle Cup w/stop
ELBE-750	Beta	PS	Push-Up	TM	Top Mount	TLC	Tripod Locking Collar
ELSS-SLDC	SceneStar®	POD	Tripod	TM-LC	Top Mount with lock	LC	Locking Collar
ELSS-XLAC2	SceneStar	POD-PL	Tripod with Portable Light Base	NB	No Bracket	WG	Wire Guard (ST only)
ELSS-XLAC	SceneStar	SB	Swivel Base	POD-Bracket	3 Piece Tripod mount	SW	Switch
ELSS-XLDC	SceneStar	RM-15	Recessed Mount w/15° angle (ELSS only)	POD-Bracket-Long	3 Piece long Tripod Mount	UI	Up Indicator Switch
ELRE-SLDC	Revel™	BL	Brow Light (SceneStar only)***	PRO	Pod Ring Only	SC	Stop Collar
ELRE-XLDC	Revel	MMST	Manual Mast	PLO	Pod Ring Long Only	SC-171	Stop Collar - AO pole
		AO	Air Operated Pole	PLMT	Portable mount for PL	WO	Wire Out The Top
		SF ****	Surface Mount	PL-Pole-MT**	PL mount on POD, PS, PU		





\*Refer to Pages 137-139 for Light Head options. NOTE: To order pole only, do not include column "A".

\*\* When ordering a PL base on a POD, PS, or PU, PL-POLE-MT must be added. Refer to Price Guide for pricing with this bracket

\*\*\* Specify CAB Type when ordering.

\*\*\*\* Available with Revel only.

### Available Plugs\*

120 V	
	L5-15 Twist Lock (Standard)
	5-15 (15 AMP)
	5-20 (20 AMP)
240 V	
	L6-20 Twist Lock

\* Specify if something other than L5-15 is required.



## Cord Reel Lights

Cord Reel Lights are reverse wired live cord reels, which allow a plug on the cord to be plugged into a power source while the Cord Reel Light is carried to the fire ground or work site. The Cord Reel Light allows the scene to be illuminated while providing a receptacle for additional tools or lights.

- Available with Beta or SceneStar
- Available with 10" and 15" cord reels
- 10" reel standard with 100' cord
- 15" reel standard with 200' cord
- See page 149 for reel details and additional options



ECRP-10-ELBE-500  
10" Cord Reel Light  
with yellow cord



ECRP-10-ELSS-XLAC

## Generator Light Kits

Our Generator Light Kits allow an Akron Brass Light Head to be mounted on a portable generator, providing a versatile portable light. These kits make it easy to light areas of a structure where typical fixed lights can not reach, or enables the release of apparatus back into service as their onboard generators and lighting are no longer needed at the emergency scene.

- 120V AC with ON/OFF switch
- Powder coated mounting brackets
- Available as a light kit for Honda EU1000i or EU2000i Generators only
- Available with SceneStar or ST series

### Additional Options

- Heavy-duty chrome-plated wire guard (ST series only)



ELSS-XLAC-HK-LKI



ELST-500-LKi





## Electric Rewind Cord Reel

These reels are built to the Akron Brass standard of performance and reliability. They have a powder coated finish and stainless steel hardware for years of durable service life. They can be mounted on the floor, back wall or even the ceiling of any compartment. The guide rollers can be ordered in various configurations to make sure the cord or hose wraps correctly no matter where the reel is mounted.



### ERWC-15-10, ERWC-16-6, ERWC-10-16 & ERWC-10-28

- Internally grounded
- Available with black or yellow cord: 12/3, 10/3 or 10/4
- All stainless steel hardware and rollers
- Red or gray powder coated finish (red is standard)
- Rolled edge discs
- Live slip ring design
- Meets NFPA requirements, allows for 10% overage of cord
- Optional cord stops available
- Direct wired gang box
- Internal collector rings come pre-wired with 1' pigtail for easy installation
- See order form for motor mount location, or visit akronbrass.com for more information



ERWC-10-28  
Shown with optional cord (Standard with speed control and guide rollers.)



ERWC-16-6  
New compact configuration for use with limited compartment space, Shown with optional guide rollers and cord

Connector Options at Cord End	
None	
Attach to Junction Box	
	5-15
	L5-15 Twistlock
	5-20
	L5-20 Twistlock

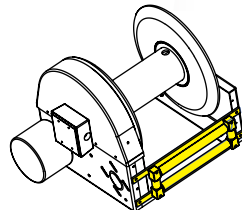

Guide Roller (GR)

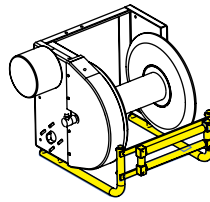

Optional 90° Guide Roller

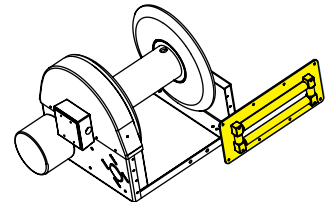

Thru Compartment/Flush Mount (GR-THRU)

Available guide roller locations on 15-10 and 16-6 reels.

### STANDARD SIZE DIMENSIONS

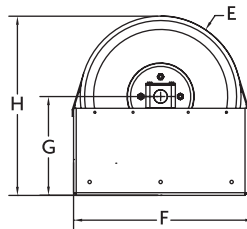
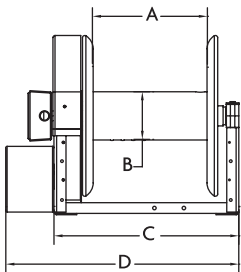

### LOW PROFILE DIMENSIONS

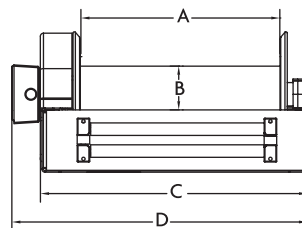

### LOW PROFILE DIMENSIONS

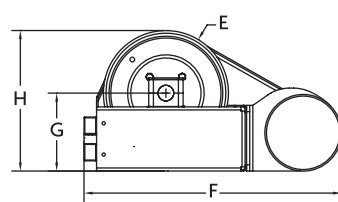

Part Number	Reel Type	A	B	C	D	E	F	G	H	12/3 Cord Capacity 300V or 600V	10/3 300V Cord Capacity	10/3 600V Cord Capacity	10/4 600V Cord Capacity	Motor Location	Power
ERWC-15-10	Standard	10.7"	4.5"	17.3"	22"	15"	17"	9.3"	16.8"	250' (76.2m)	250' (76.2m)	200' (61m)	200' (61m)	Side Mount	Solenoid Only
ERWC-16-6	Standard	5.6"	4.5"	11"	15.2"	16.5"	17"	9.3"	17.7"	175' (53.3m)	200' (61m)	150' (45.7m)	--	Side Mount	Solenoid Only
ERWC-10-16	Low Profile	16"	4.5"	21.3"	23.7"	10"	19.6"	6.2"	11.2"	150' (45.7m)	150' (45.7m)	100' (30.5m)	100' (30.5m)	Rear Mount	Speed Control
ERWC-10-28	Low Profile	16"	4.5"	33.4"	35.7"	10"	19.6"	6.2"	11.2"	250' (76.2m)	250' (76.2m)	200' (61m)	200' (61m)	Rear Mount	Speed Control



### Manual Cord Reel

Akron Brass Cord Reels are portable. The Cord Reel allows for fast, easy deployment and retraction of extension cords without the hassle of twisting or knotting. Akron Cord Reels are available in Live configurations only.



- All live reels are internally grounded
- Available in 2 sizes; 10", & 15"
- Heavy-duty construction
- Powder coated red
- Live slip ring design
- Adjustable tension nut
- Meets NFPA requirements
- Standard with Gang Box
- Black or yellow cords



ECRP-10-GB  
10" Live Cord Reel  
with gang box

#### Additional Options

- NEMA plugs and receptacles (See below for options)
- ECR-MT cord reel mounting bracket

**ECRP-10-GB & ECRP-15-GB** are live cord reels with a gang box permanently mounted to the axle. Simply plug the cord into a receptacle and carry the reel to the fire ground or work site.



ECR-MT  
Cord Reel  
mounting brackets

Cord Type	10" Cord Reel Capacity	Weight W/cord	15" Cord Reel Capacity	Weight W/cord
12/3-300 Volt	100' (30.5 m)	22# (10 kg)	200' (61 m)	46# (20.1 kg)

See page 146 for details on cord reel lights



ECRP-10-ELBE-500  
10" Cord Reel Light  
with yellow cord



ECRP-10-ELSS-XLAC

Gang Box Receptacle	
	15A GFCI Duplex
	20A GFCI Duplex
	5-15, 15A Household Straight Blade Duplex
	5-20, 20A Household Straight Blade Duplex
	L5-15, 15A Twistlock (Duplex)
	L5-20, 20A Twistlock

Plug	
None	
	5-15, 15A Household Straight Blade
	5-20, 20A Household Straight Blade
	L5-15, 15A Twistlock
	L5-20, 20A Twistlock







### EJBX - Junction Box

The Akron Brass Junction Box is a must have on every apparatus, as it provides easy distribution of power for your electrical needs on the fire ground. The Junction Box's durable design utilizes a heavy duty powder coated aluminum housing with a large integral handle and internally backlit faceplates. This makes the Junction Box easy to carry with excellent visibility, allowing easy electrical connection in the darkest conditions. Akron Brass Junction Boxes can be configured to meet your department's needs. Inlet options include: a flanged inlet plug, a 12" pigtail with any grounded NEMA plug configurations, or pre-wired for hard wiring the unit onto a cord reel or electrical cord set. Outlet receptacle options include NEMA configurations for each of the four receptacles.

- Durable powder coated aluminum construction
- Backlit faceplates
- Custom configurations
- Easy to carry
- UL listed plugs and receptacles
- Meets NFPA requirements
- 9 1/4" (235 mm) L x 5 1/2" (104 mm) W x 8 1/2" (216 mm) H
- Standard color: Gray

#### Additional Options:

- 30 Amp or dual inlet configurations
- GFCI protected receptacles



EJBX-VMT-TP  
Aluminum treadplate  
vertical mounting bracket



EJBV-HMT-TP  
Aluminum treadplate  
horizontal mounting bracket



JUNCTION BOX OPTIONS	
EJBX-VMT-TP	Aluminum treadplate vertical mounting bracket
EJBV-HMT-TP	Aluminum treadplate horizontal mounting bracket
EJBX-GFI	Household duplex receptacle (Note: The GFCI receptacle will be wired first making all down stream receptacles protected unless requested otherwise).



Junction Box  
ready for  
Direct Wiring

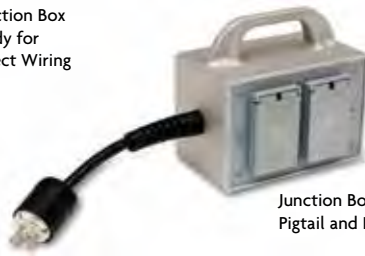

Junction Box with  
Pigtail and Plug

Pigtail Plug Cord Options		
NEMA #		Description
5-15		15 AMP, 125V Straight Blade
5-20		20 AMP, 125V Straight Blade
L5-15		15 AMP, 125V Twist Lock
L5-20		20 AMP, 125V Twist Lock

Receptacle Options		
NEMA #		Description
5-15		Single 15 AMP, 125V Straight Blade
5-15 Duplex		Duplex 15 AMP, 125V Straight Blade
5-15 GFCI Duplex		Duplex 15 AMP, 125V Straight Blade
5-20		Single 20 AMP, 125V Straight Blade
5-20 Duplex		Duplex 20 AMP, 125V Straight Blade

NEM #		AMP/V
5-20 GFCI Duplex		GFCI, Duplex 20 AMP, 125V Straight Blade
L5-15		Single 15 AMP, 125V Twist Lock
L5-15 Duplex		Duplex 15 AMP, 125V Twist Lock
L5-20		20 AMP, 125V Twist Lock
L5-30		30 AMP, 125V Twist Lock. (used with direct wire inlet only)

## Trooper Bar™

The Trooper Bar is a truly multiple purpose utility bar. The unique gooseneck shaped design creates a high degree of leverage forcing your way through the obstruction. This maximizes prying force for quick entry.

- 50 Trooper Bar**
- Solid one piece construction
  - Zinc-plated
  - Gooseneck design
  - Length: 26" (660 mm)
  - Weight: 8 1/2 lbs. (3.9 kg)



## Hydrant Wrenches

- Adjustable to 1 3/4" (44 mm) pentagon or 1 1/4" (32 mm) square nut
- Plated for corrosion resistance
- Designed to prevent hydrant nut damage
- Spanner fits 2 1/2" (64 mm) to 4 1/2" (114 mm) rocker lug or pin lug couplings
- Replaceable brass inserts

- 15 Hydrant and Spanner Wrench**
- Length: 19 1/2" (495 mm), weight: 5 lbs. (2.2 g)
- 17 Adjustable Hydrant Wrench**
- Length: 18 5/8" (473 mm), weight: 4 1/2 lbs. (2 kg)

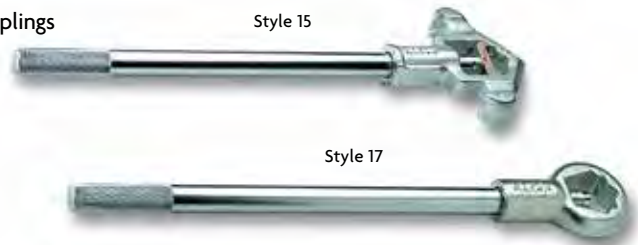

## Spanner Wrenches

- 10 Universal Spanner Wrench**
- The all-purpose wrench for 3/4" (19 mm) to 3" (76 mm) rocker lug and pin lug couplings. Features a belt hook eye, hammer head and a gas cock shutoff.
- Akrolite™ construction
  - Length: 11 1/2" (292 mm), weight: 8 oz. (227 g)



- 13 Folding Pocket Spanner**
- Fits all 3/4" (19 mm) to 3" (227 g) rocker lug and pin lug couplings.
- Brass construction
  - Length: 5 1/8" (130 mm) (folded), weight: 8 oz. (227 g)



- 14 Folding Pocket Spanner**
- Fits all 3/4" (119 mm) to 3" (76 mm) rocker lug and pin lug couplings.
- Akrolite construction
  - Length: 5 1/8" (130 mm) (folded), weight: 4 oz. (113 g)



- 19 Universal Suction Spanner Wrench**
- An all-purpose wrench for long handle, rocker lug, or pin lug couplings from 2 1/2" to 6". Open end slips over long handles for additional leverage and claw fits rocker or pin lugs. The opposite end can be used as a pry or crowbar. Inverted "T" body construction for light weight and added strength.
- Plated steel
  - Length: 18 3/4" (476 mm), weight: 3 1/4 lbs. (1.5 kg)



- 25 Hole Type Spanner Wrench**
- For hole type, rocker lug and pin lug couplings. Plated for corrosion resistance. Specify either 3/4" (19 mm) - 1" (25 mm) or 2 1/2" (64 mm) size.
- Plated steel construction
  - Length: 7" (178 mm), weight: 12 oz. (340 g)



- 46 Fitzall Combination Spanner**
- Designed to fit rocker lug and pin lug couplings from 3/4" (19 mm) to 4" (102 mm). Gas shutoff in handle.
- Akrolite construction
  - Length: 10 1/4" (260 mm), weight: 8 oz. (227 g)
  - NSN 5120-00-018-1519







### Aluminum Wrench Holders

Anodized Aluminum Dual Wrench Holder is designed so wrenches can be removed or replaced with one hand.

- Anodized aluminum for added durability
- 2 or 3 wrench options
- Designed so wrenches can be removed with one hand

- 441 3 Wrench Holder**
- 442 3 Wrench Holder with (1) 15 & (2) 46**
- 443 3 Wrench Holder with (1) 15 & (2) 10**
- 446 2 Wrench Holder**
  - Size: 5" (127 mm) x 11 1/2" (292 mm), weight: 1 1/2 lbs. (.68 kg)
- 447 2 Wrench Holder with Wrenches**
  - Holder with (2) Style 46 wrenches
- 448 2 Wrench Holder with Wrenches**
  - Holder with (2) Style 10 wrenches
- 449 2 Wrench Holder with Wrenches**
  - Holder with (1) Style 10 and (1) Style 46 wrench



### Nylon Wrench Holder/Sets

Impact resistant Nylon Wrench Holder is designed to hold either (2) Spanners or (2) Spanners and a Hydrant Wrench. Holders will withstand temperatures to -40° F and have a 10 year guarantee against breakage.

- 2441 3 Wrench Holder**
  - Size: 4 1/2" (114 mm) x 10" (254 mm), weight: 10 oz. (284 g)
- 2442 3 Wrench Holder with Wrenches**
  - Holder with (1) Style 15 and (2) Style 46 wrenches
- 2443 Wrench Holder with Wrenches**
  - Holder with (1) Style 15 and (2) Style 10 wrenches
- 2446 2 Wrench Holder**
  - Size: 4 1/2" (114 mm) x 7 1/2" (191 mm), weight: 8 oz. (227 g)
- 2447 2 Wrench Holder with Wrenches**
  - Holder with (2) Style 46 wrenches
- 2448 2 Wrench Holder with Wrenches**
  - Holder with (2) Style 10 wrenches



### Tool Brackets

These heavy-duty Tool Brackets have covered jaws for securing various tools.

- 39 3/4" - 1" Horizontal Tool Bracket**
  - Fits smaller tools and applicators with 3/4" to 1" O.D.
  - Length: 3 7/8" (98 mm), weight: 4 oz. (118 ml)
  - Fits Styles 15, 17, 19
- 40 1 1/2" - 2 1/2" Horizontal Tool Bracket**
  - Designed for 1 1/2" and 2 1/2" applicators and other tools, such as axe handles, with a 1 1/8" to 1 3/4" O.D.
  - Length: 4 1/8" (105 mm), weight: 4 oz. (118 ml)
  - Fits Styles 1088, 2055, 2015, 2415, 2225
- 41 3/4" - 1" Vertical Tool Bracket**
  - Same as Style 39 except for vertical mount
  - Length: 5 3/8" (137 mm), weight: 4 oz. (118 ml)
  - Fits Styles 15, 17, 19
- 42 1 1/2" - 2 1/2" Vertical Tool Bracket**
  - Same as Style 40 except for vertical mount
  - Length: 5 5/8" (143 mm), weight: 4 oz. (118 ml)
  - Fits Styles 1088, 2055, 2015, 2415, 2225



KEY	
*	Pyrolite
#	Cast brass
◇	Chrome plated brass



<b>630</b> <b>Angle Elbow</b> SWIVEL FEMALE x MALE
◇ 2 1/2" NH x 2 1/2" NH (65 x 65 mm)



<b>635</b> <b>90° Continuous Swiveling Elbow</b> FEMALE NPT x MALE NH or NPSH
• Full 2" (51 mm) waterway with cast-in turning vane
# 1 1/2" or 2" female x 1 1/2" male (38 or 50 x 38 mm) 4 5/8" length
# 2 1/2" female x 2 1/2" male (65 x 65mm) 5" length



<b>347</b> <b>Hose Plug</b>
• Available with rocker lug
• Chain or jack chain
◇ 1 1/2" NH (38 mm)
◇ 2 1/2" NH (65 mm)



<b>345</b> <b>Hose Cap</b>
• Available with rocker lug
• Chain optional
◇ 1 1/2" NH (38 mm)
◇ 2 1/2" NH (65 mm)



<b>330</b> <b>Short Internal Lug Adapter</b> FEMALE NPT x MALE
◇ 2 1/2" NPT x 2 1/2" NH (65 x 65 mm)



<b>335</b> <b>Double Female Swivel Adapter</b>
* ◇ 2 1/2" NH (65 mm)



<b>336</b> <b>Double Male Adapter</b>
* ◇ 2 1/2" NH (65 mm)



<b>337</b> <b>Rigid Female to Male Adapter</b>
◇ 1" NH x 1 1/2" NH (25 x 38 mm)
◇ 2" NH x 1 1/2" NH (50 x 38 mm)
* ◇ 2 1/2" NH x 1 1/2" NH (65 x 38 mm)



<b>338</b> <b>Suction Lug Adapter with Strainer</b> FEMALE NPT x FEMALE SWIVEL
◇ 1 1/2" NPT x 1 1/2" NH (38 x 38 mm)
◇ 2 1/2" NPT x 2 1/2" NH (65 x 65 mm)

- 1422 Rigid Direct Connect Base**
- For adapting an 1 1/2" nozzle base to a 2 1/2" hose line
  - Pyrolite® construction
  - 2 1/2" female x 1 1/2" male
  - Tapered waterway for reduced turbulence
  - Weight: 12 oz. (340 g)



Style 1422

- 631 60° Angle Elbow**
- For high-rise stand pipes
  - Pyrolite® finish
  - 2 1/2" female x 2 1/2" male
  - Weight: 1 7/8 lbs. (.9 kg)



Style 631

- 650 Swiveling Elbow**
- For aerial applications
  - Pyrolite finish
  - Full flow waterway with cast-in turning vanes for reduced friction loss
  - Available in 4", 5" and 6" sizes
  - Weight: 8 3/4 lbs. (4 kg)



Style 650



### Suction Strainers

#### 339 Basket Suction Strainer

An economical, high capacity suction strainer with galvanized plated mesh for longer life.

- Available in 2 1/2" (65 mm) and 5" (127 mm) size NH and other selected threads
- 2 1/2" (65 mm) barrel strainer length: 4 7/8" (124 mm), weight: 2 lbs. (.9 kg)

#### 340 Barrel Suction Strainer

Heavy-duty barrel suction strainer with rope eye. Capable of flowing large volumes of water to match today's high capacity pumps.

- Pyrolite® finish
- Available in 4" (102 mm) through 6" (152 mm) NH; 5" (127 mm) weight: 4 1/4 lbs. (1.9 kg)
- 5" (127 mm) barrel strainer length: 10" (254 mm), weight: 4 1/4 lbs. (1.9kg)



Style 339



Style 340

### Hose Jackets

#### 772 2 1/2" (64 mm) Hose Jacket

For emergency repair of burst or leaky hose - or as an emergency adapter for the connection of two hose lines with different threads in situations where pressures do not exceed 150 psi (10.34 bar).

- Akrolite® construction and molded neoprene liner
- Fits all 2 1/2" (64 mm) hose from 2 3/4" (70 mm) to 3 5/16" (84 mm) O.D.
- Length: 13" (330 mm), weight: 16 1/2 lbs. (7.5 kg)

#### 773 3" (76 mm) Hose Jacket

- Same as Style 772, except: Fits 3" (76 mm) hose from 3 1/2" (89 mm) to 3 3/4" (95 mm) O.D.
- Length: 15" (381 mm), weight: 26 3/4 lbs. (12.1 kg)

#### 352 2 1/2" (64 mm) Hose Jacket Mounting Peg

- For mounting 2 1/2" (64 mm) hose jacket on a running board or in a compartment
- Length: 13 3/8" (340 mm), weight: 2 1/4 lbs. (1 kg)

#### 353 3" (76 mm) Hose Jacket Mounting Peg

- Same as Style 352, except for 3" (76 mm) hose jacket
- Length: 15 1/2" (394 mm), weight: 3 3/4 lbs. (1.7 kg)



Style 772

### Hose Clamp

#### 588 Hose Clamp

- For use on double-jacketed woven hose up to 3" (76 mm)
- Rubber jaws and lock
- Lightweight for easy handling
- Supplied with Style 589 mounting bracket
- Length: 30" (762 mm), weight: 16 lbs. (7.3 kg)

#### 589 Hose Clamp Mounting Bracket

- For Style 588 Hose Clamp



Style 588



## Tool Kit

### 9200 Nozzle Repair Tool Kit

The Nozzle Repair Tool Kit contains the essential tools for Akron Brass nozzle repair. All tools are packaged in a sturdy carrying bag. The repair kit is warranted for 1 year.

- Tools include:
  - 3 Swivel Adapter Tools and Rod
  - Akron Brass logoed carrying bag



Style 9200

## Equipment Holders

### 350 Mounting Plate

- Chrome plated
- Available in 1.5", 2.5", 3.5", 4.5" & 6"
- NH Only
- For securing equipment with female threads
- Screw type mount with bolt holes in the center for neat appearance
- 2 1/2" (64 mm) weight: 12 oz. (340 g)



Style 350

### 373 E-Z - Lok Nozzle Holder

- Available in 1 1/2" (38 mm) and 2 1/2" (64 mm) sizes - Must specify
- For securing equipment with female threads
- Quick release for fast and easy mounting and removal
- Weight: 1 5/8 lbs. (.7 kg)



Style 373

## Sprinkler Shutoff

### 1078 Quickfit Sprinkler Shutoff

Simple, quick, positive shutoff for many types of sprinkler heads with openings of approximately 7/8" (22 mm) wide by 1" (25 mm) high or 3/4" (19 mm) wide by 1 1/16" (43 mm) high. Allows sprinkler heads out of fire area to be shut off. Weight: 6 oz. (170 g)



Style 1078



### Lubricants

Repair instructions for Akron® products often call for lubricants to ensure proper repair and long term service.

- 9201 Parker® O-Lube**
  - 4 oz. (113 g) tube
- 9202 Low-Temp Lubriplate® Grease**
  - 10 oz. (284 g) tube
- 9203 Low-Temp Lubriplate® Grease**
  - 14 1/2 oz. (411 g) cartridge
- 9210 Mobilith SHC 460 Synthetic Grease**
  - 13.7 oz. (390g) tube



Style 9201



Style 9202



Style 9203



Style 9210

### Hose Accessories

- 583 Hose Hoist**
  - Akrolite™ construction
  - For raising or lowering hose, ladders, etc. to and from the roof or through windows
  - Weight: 7 1/8 lbs. (3.4 kg)
- 78 Hose & Ladder Strap**
  - Secures hose up to 3" (76 mm) on ladders, fire escapes, etc. and aids in the handling of hose
  - Anodized aluminum fittings with 1" (25 mm) wide, flat, water-resistant nylon webbing
  - Fits ladder rungs up to 2" (51 mm) O.D.
  - Weight: 1 lbs. (.5 kg)



Style 78



Style 583

To place an order, state the style number, inlet and outlet adapters needed (always list inlet adapter first), and the type of handle/actuator. All threaded adapters require thread information. Rigid female adapters are available only with tapered pipe thread (NPT). Hose threaded adapters will be supplied with National Hose (NH) thread unless otherwise specified.

Style	Description	Ball Type	Actuators
8620	2" Heavy Duty Non-Locking Swing-Out Valve	Stainless Steel	SZ, R/S, EA or GA
8625	2 1/2" Heavy Duty Non-Locking Swing-Out Valve	Stainless Steel	SZ, R/S, EA or GA
8630	3" Heavy Duty Non-Locking Swing-Out Valve	Stainless Steel	SZ, R/S, EA or GA
8635	3 1/2" Heavy Duty Non-Locking Swing-Out Valve	Stainless Steel	SZ, R/S, EA or GA
8810	1" Heavy Duty "Self Locking" Swing-Out Valve	Stainless Steel	R1, TS, TSC
8815	1 1/2" Heavy Duty "Self Locking" Swing-Out Valve	Stainless Steel	R1, TS, TSC
8820	2" Heavy Duty "Self Locking" Swing-Out Valve	Stainless Steel	R1, SZ, TS, or TSC
8825	2 1/2" Heavy Duty "Self Locking" Swing-Out Valve	Stainless Steel	R1, SZ, TS, or TSC
8830	3" Heavy Duty "Self Locking" Swing-Out Valve	Stainless Steel	R1, SZ, TS, or TSC
8835	3 1/2" Heavy Duty "Self Locking" Swing-Out Valve	Stainless Steel	R1, SZ, TS, or TSC
8840	4" Heavy Duty "Self Locking" Swing-Out Valve	Bronze, Flat	Air, EA or GA
8910	1" Heavy Duty "Self Locking" Swing-Out Valve	Polymer	R1, TS, TSC
8915	1 1/2" Heavy Duty Swing-Out Valve	Polymer	R1, TS, TSC
8920	2" Heavy Duty Swing-Out Valve	Polymer	R1, TS, TSC, SZ, R/S, EA or GA
8925	2 1/2" Heavy Duty Swing-Out Valve	Polymer	R1, TS, TSC, SZ, R/S, EA or GA
8930	3" Heavy Duty Swing-Out Valve	Polymer	R1, TS, TSC, SZ, R/S, EA or GA
8935	3 1/2" Heavy Duty Swing-Out Valve	Polymer	R1, TS, TSC, SZ, R/S, EA or GA
8940	4" Heavy Duty Swing-Out Valve	Polymer	Air, EA or GA



Actuator/Handle

Actuator/Handle Type	Options Order Code
R1	R1
TS	TS
TSC	TSC
SZ	SZ
Gear Actuator	GA
Electric Actuator	EA
Rack & Sector	RS

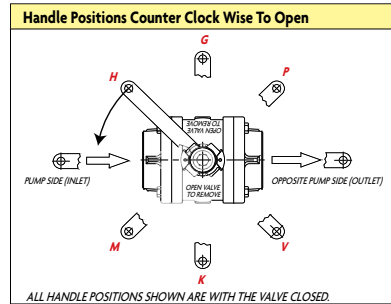
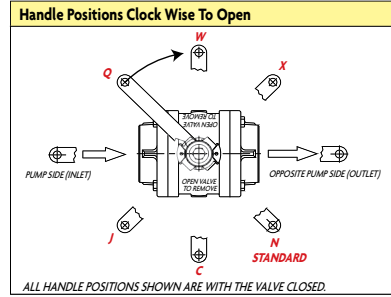

**Inlet/Pump Side Adapter (See Adapter List)**

**Outlet Adapter (See Adapter List)**



**Valve Body**  
Select style number from chart

**Inlet Adapter**  
Select from adapter list

**Outlet Adapter**  
Select from adapter list

Enter "CH" to specify chrome option where available. Refer to adapter list for availability. Leave Blank for Standard Cast Finish

**Specify Actuator**  
Select from actuator chart above

**Specify Actuator Position**  
See chart at right for positions.  
"N" is standard for manual actuators

**Optional Slo-Cloz™**  
Enter "SC" to specify or leave blank for no Slo-Cloz

Example shown is a 2 1/2" valve with composite ball. It has a P1-S inlet adapter and a ME1-S outlet adapter, with chrome plating. The valve has a TS handle in standard position "N" and does not have Slo-Cloz installed.

\* For special configurations, contact Akron Brass customer care

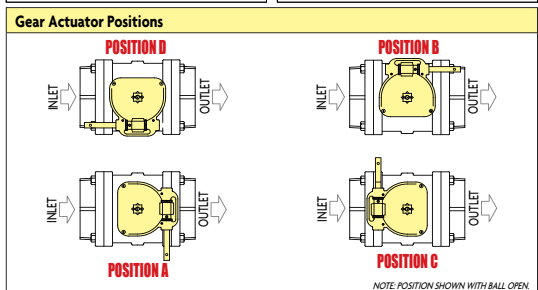
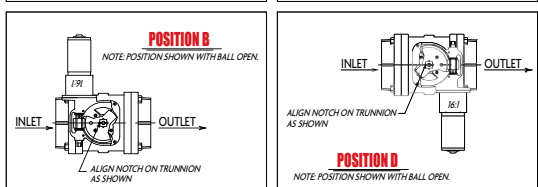
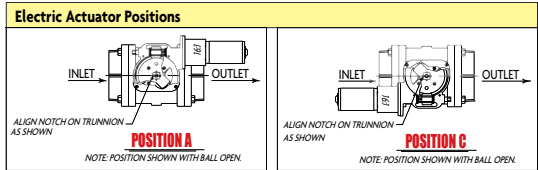





### VALVE TECHNICAL INFORMATION

#### BODY DIMENSION KEY

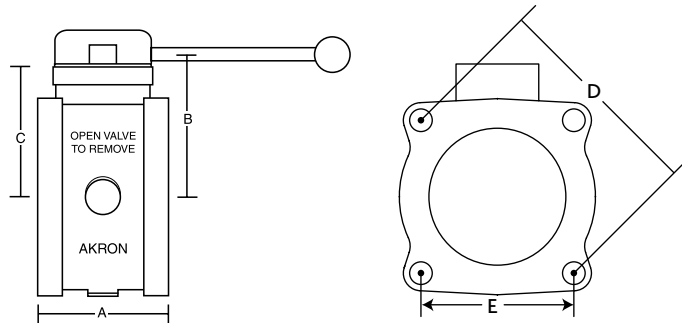

- A: Overall body length
- B: From centerline of waterway to centerline of handle
- C: From centerline of waterway to actuator mounting surface
- D: Bolt circle diameter for valve adapter holes
- E: Linear dimension for valve adapter holes

#### Torque Requirements Styles 8620-8635, 8810-8840 and 8910-8940

The following is to be used for torquing the hex head bolts which hold the adapters to the body.

VALVE	TORQUE REQUIREMENT
8810/8910	100-120 Inch Pounds
8815/8915	216-240 Inch Pounds
8620/8820/8920	25-30 Foot Pounds
8625/8825/8925	25-30 Foot Pounds
8630/8830/8930	38-40 Foot Pounds
8635/8835/8935	38-40 Foot Pounds
8840/8940	60-70 Foot Pounds

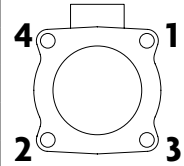

NOTE: Bolts are to be tightened evenly. Tighten opposite bolts in sequence as indicated below, not adjacent bolts in sequence. After all bolts are initially tightened, repeat the process in the same sequence.

#### 8600, 8800 & 8900 Series Valves

STYLE	SIZE	A	B		C	D	E
			R-1	SZ			
8810 8910	1" (25 mm)	1 13/16" (46 mm)	2 25/64" (61 mm)	-	1 13/16" (46 mm)	2 3/4" (70 mm)	2" (51 mm)
8815 8915	1 1/2" (38 mm)	2 1/4" (57 mm)	3 3/16" (81 mm)	-	2 1/8" (54 mm)	3 1/2" (89 mm)	2 1/2" (64 mm)
8620 8820 8920	2" (51 mm)	3" (76 mm)	3 3/4" (95 mm)	4 5/32" (106 mm)	2 3/4" (70 mm)	4 1/2" (114 mm)	3 1/4" (82.55 mm)
8625 8825 8925	2 1/2" (64 mm)	3 1/2" (89 mm)	4 1/8" (105 mm)	4 3/16" (106 mm)	3 1/8" (79 mm)	5 3/8" (137 mm)	3 3/4" (95 mm)
8630 8830 8930	3" (76 mm)	4" (102 mm)	4 5/8" (105 mm)	4 9/16" (116 mm)	3 1/2" (89 mm)	6 1/8" (156 mm)	4 1/4" (107.95 mm)
8835 8935	3 1/2" (89 mm)	4" (102 mm)	4 1/2" (114 mm)	4 9/16" (116 mm)	3 1/2" (89 mm)	6 1/8" (156 mm)	4 1/4" (107.95 mm)
8840	4" (102 mm)	4" (102 mm)	-	-	4 1/8" (105 mm)	7 1/16" (179 mm)	5" (127 mm)
8940	4" (102 mm)	6" (152 mm)	-	-	4 1/8" (105 mm)	7 1/16" (179 mm)	5" (127 mm)

#### Cutout Dimensions Position Indicator

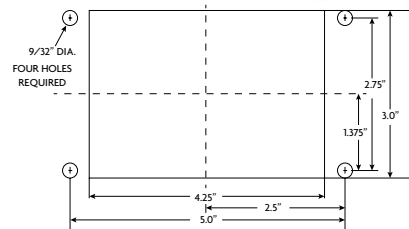

	Air Actuator		Handwheel Actuator			Rack & Sector		Slo-Cloz™		Electric	
Size	A	B	A	B	C	A	B	7875	7675	A	B
2"	-	-	10 1/2" (267 mm)	1 21/32" (42 mm)	4" (102 mm)	-	-	1 7/8" (48 mm)	2 3/8" (60 mm)	12 1/4" (311 mm)	3 11/16" (94 mm)
2 1/2"	-	-	10 1/2" (267 mm)	1 21/32" (42 mm)	4" (102 mm)	4 13/16" (122 mm)	3 1/2" (89 mm)	1 7/8" (48 mm)	2 3/8" (60 mm)	12 1/4" (311 mm)	3 11/16" (94 mm)
3"	-	-	10 1/2" (267 mm)	1 21/32" (42 mm)	4" (102 mm)	4 13/16" (122 mm)	3 7/8" (98 mm)	1 7/8" (48 mm)	2 3/8" (60 mm)	12 1/4" (311 mm)	3 11/16" (94 mm)
3 1/2"	-	-	10 1/2" (267 mm)	1 21/32" (42 mm)	4" (102 mm)	4 13/16" (122 mm)	3 7/8" (98 mm)	1 7/8" (48 mm)	2 3/8" (60 mm)	12 1/4" (311 mm)	3 11/16" (94 mm)
4"	7 1/2" (191 mm)	11 1/4" (286 mm)	12 7/16" (316 mm)	3 1/8" (79 mm)	6" (152 mm)	-	-	-	-	12 1/4" (311 mm)	4 1/8" (105 mm)

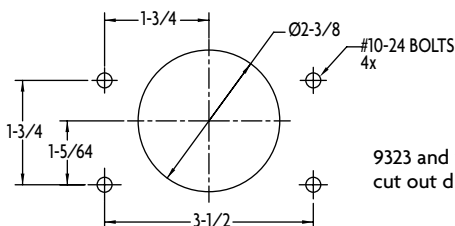

9323 and 9325 Valve Controller cut out dimensions

### Valve Dimension Key

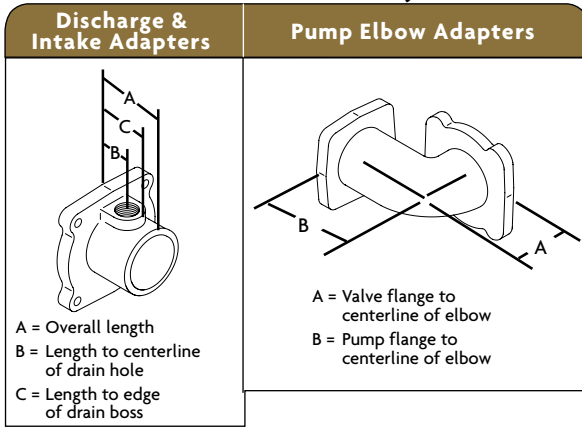











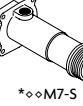

KEY	
*	1/4" and 3/4" NPT taps
**	(2) 3/4" NPT taps
***	3/4" NPT tap
↑	30° Angle
↑↑	90° Angle
↑↑↑	Includes Strainer
+	Eccentric flange face
++	Slotted valve flange
+++	8 holes flange - Use 4
◇	(3) 3/4" NPT Taps
◇◇	Available in Cast or Chrome
#	For spacing only. 4 3/8" BCD each end.
##	For use when replacing a 7840 with an 8840. Each adapter is 1" thick.
###	(2) 3/4" NPT Taps and (1) 1" NPT Tap
◀	Non-standard items. May have longer lead times.

### Rigid NPT

STYLE		SIZE						
		1" (25 mm)	1 1/2" (38 mm)	2" (50 mm)	2 1/2" (65 mm)	3" (75 mm)	3 1/2" (89 mm)	4" (100 mm)
M1-S	A	1 21/32" (42 mm) ◀	1 5/16" (33 mm)	1 5/8" (41 mm)	2" (51 mm)	2 1/16" (52 mm)	-	2 21/32" (75 mm) ◀
	B	-	-	-	-	-	-	-
	C	-	-	-	-	-	-	-
M12-S	A	-	-	1 15/16" (49 mm)	-	3 3/4" (95 mm) ◀	-	-
	B	-	-	-	-	-	-	-
	THREAD	-	-	2 1/2" NPT (64 mm)	-	4" NPT (102 mm) ◀	-	-
P1-S	A	1 1/8" (29 mm)	1 1/8" (29 mm)	1 1/4" (32 mm)	1 7/8" (48 mm)	1 7/8" (48 mm)	2" (51 mm)	2 1/8" (54 mm)
	B	-	-	-	-	-	-	-
	C	-	-	-	-	-	-	-
* P2-S	A	-	3 3/8" (86 mm)	3 1/4" (83 mm)	3 19/32" (91 mm)	3 7/16" (87 mm)	4" (102 mm)	4 5/16" (110 mm)
	B	-	1 5/8" (41 mm)	1 3/8" (35 mm)	1 3/8" (35 mm)	1 3/8" (35 mm)	1 3/8" (35 mm)	1 3/8" (35 mm)
	C	-	1 3/8" (35 mm)	2 1/8" (54 mm)	2 1/8" (54 mm)	2 1/8" (54 mm)	2 1/8" (54 mm)	2 19/32" (66 mm)
P10-S	A	-	1 1/4" (32 mm) ◀	2 1/32" (52 mm) ◀	3 5/16" (84 mm) ◀	-	-	-
	B	-	-	-	-	-	-	-
	THREAD	-	2" NPT (51 mm) ◀	2 1/2" NPT (64 mm) ◀	3" NPT (76 mm) ◀	-	-	-
* P12-S	A	-	-	-	-	3 3/4" (95 mm)	-	-
	B	-	-	-	-	1 3/8" (35 mm)	-	-
	THREAD	-	-	-	-	4" NPT (102 mm)	-	-
P20-SF	A	-	-	3 5/32" (80 mm) ◀	3 7/16" (87 mm)	4" (102 mm)	-	4" (102 mm)
	THREAD	-	-	2" NPT (51 mm) ◀ 2 1/2" VIC (64 mm) ◀	2 1/2" NPT (64 mm) 3" VIC (76 mm)	3" NPT (76 mm)	-	4" NPT (102 mm)
	For Flow Meter							
◊ ### P30-SCV	A	-	5 5/8" (143 mm) ◀	5 27/32" (148 mm)	6 1/4" (159 mm) ◀	7 1/2" (191 mm)	-	-
	B	-	1 21/32" (42 mm) ◀	3 7/8" (98 mm)	4 9/32" (109 mm) ◀	4 15/16" (125 mm)	-	-
	THREAD	-	1 1/2" NPT (34 mm) ◀ 2" VIC (51 mm) ◀	2" NPT (51 mm)	2 1/2" NPT (64 mm) ◀	3" NPT (76 mm)	-	-
Built-in Check Valve								

## Male Discharge Adapters









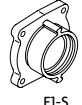

STYLE	SIZE							
	1" (25 mm)	1 1/2" (38 mm)	2" (51 mm)	2 1/2" (64 mm)	3" (76 mm)	3 1/2" (89 mm)	4" (102 mm)	
 ◊◊M1-S	A	1 11/16" (42 mm) ◀	1 5/16" (33 mm)	1 5/8" (41 mm)	2" (51 mm)	1 7/8" (48 mm)	-	2 27/32" (67 mm) ◀
	B	-	-	-	-	-	-	-
	C	-	-	-	-	-	-	-
 ◊◊M2-S	A	-	-	1 15/16" (49 mm) ◀	-	-	-	-
	B	-	-	-	-	-	-	-
	THREAD	-	-	2 1/2" NH (64 mm) ◀	-	-	-	-
 *◊◊M3-S	A	-	-	-	3 3/16" (81 mm)	3 5/16" (84 mm) ◀	-	3 19/32" (91 mm)
	B	-	-	-	1 3/8" (35 mm)	1 3/8" (35 mm) ◀	-	1 13/16" (46 mm)
	C	-	-	-	2 1/8" (54 mm)	2 1/8" (54 mm) ◀	-	2 5/8" (67 mm)
 *◊◊M4-S	A	-	-	-	5" (127 mm)	5" (127 mm)	-	8 3/4" (222 mm)
	B	-	-	-	1 3/8" (35 mm)	1 3/8" (35 mm)	-	1 13/16" (46 mm)
	C	-	-	-	2 1/8" (54 mm)	2 1/8" (54 mm)	-	2 15/32" (63 mm)
 *◊◊M6-S	A	-	-	-	10" (254 mm) ◀	-	-	-
	B	-	-	-	1 3/8" (35 mm) ◀	-	-	-
	C	-	-	-	2 1/8" (54 mm) ◀	-	-	-
 *◊◊M7-S	A	-	-	-	6 1/2" (165 mm) ◀	-	-	-
	B	-	-	-	1 3/8" (35 mm) ◀	-	-	-
	C	-	-	-	2 1/8" (54 mm) ◀	-	-	-
 *M8-S	A	-	-	2 7/8" (73 mm) ◀	-	-	-	-
	C	-	-	1 17/64" (32 mm) ◀	-	-	-	-
	THREAD	-	-	1 1/2" NH (38 mm) ◀	-	-	-	-
 *M10-S	A	-	-	3 7/32" (82 mm) ◀	-	-	-	-
	B	-	-	1 25/64" (35 mm) ◀	-	-	-	-
	THREAD	-	-	2 1/2" NH (64 mm) ◀	-	-	-	-
 *†◊◊ ME1-S	A	-	-	-	6 5/8" (168 mm)	7" (178 mm)	-	9 3/4" (248 mm) ◀
	B	-	-	-	1 3/8" (35 mm)	1 3/8" (35 mm)	-	1 5/8" (41 mm) ◀
	C	-	-	-	2 1/8" (54 mm)	2 1/8" (54 mm)	-	2 3/16" (59 mm) ◀
 **† ME2-S	A	-	-	-	-	-	5 1/8" (130 mm)	-
	B	-	-	-	-	-	1 3/8" (35 mm)	-
	C	-	-	-	-	-	2 1/8" (54 mm)	-
 *†◊◊ ME3-S	A	-	-	-	10 5/16" (278 mm)	-	-	-
	B	-	-	-	1 3/8" (35 mm)	-	-	-
	C	-	-	-	2 1/8" (54 mm)	-	-	-
 *†◊◊ ME4-S	A	-	-	-	12 5/16" (313 mm) ◀	-	-	-
	B	-	-	-	1 3/8" (35 mm) ◀	-	-	-
	C	-	-	-	2 1/8" (54 mm) ◀	-	-	-
 *†◊◊ ME5-S 2 1/2" Thread	A	-	-	-	-	6 7/8" (175 mm) ◀	-	-
	B	-	-	-	-	1 3/8" (35 mm) ◀	-	-
	C	-	-	-	-	2 1/8" (54 mm) ◀	-	-

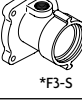
KEY	
*	1/4" and 3/4" NPT taps
**	(2) 3/4" NPT taps
***	3/4" NPT tap
†	30° Angle
††	90° Angle
†††	Includes Strainer
+	Eccentric flange face
++	Slotted valve flange
+++	8 holes flange - Use 4
◊	(3) 3/4" NPT Taps
◊◊	Available in Cast or Chrome
#	For spacing only 4 3/8" BCD each end.
##	For use when replacing a 7840 with an 8840. Each adapter is 1" thick.
###	(2) 3/4" NPT Taps and (1) 1" NPT Tap
◀	Non-standard items. May have longer lead times.

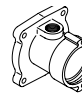
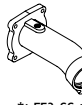

## Female Intake Adapters Chrome Swivels (Hose Thread)

KEY	
*	1/4" and 3/4" NPT taps
**	(2) 3/4" NPT taps
***	3/4" NPT tap
†	30° Angle
††	90° Angle
†††	Includes Strainer
+	Eccentric flange face
++	Slotted valve flange
+++	8 holes flange - Use 4
◇	(3) 3/4" NPT Taps
◇◇	Available in Cast or Chrome
#	For spacing only. 4 3/8" BCD each end.
##	For use when replacing a 7840 with an 8840. Each adapter is 1" thick.
###	(2) 3/4" NPT Taps and (1) 1" NPT Tap
◀	Non-standard items. May have longer lead times.

STYLE		SIZE					
		1 1/2" (38 mm)	2" (51 mm)	2 1/2" (64 mm)	3" (76 mm)	3 1/2" (89 mm)	4" (102 mm)
 F1-S	A	-	-	2 15/16" (75 mm) ◀	-	-	-
	B	-	-	-	-	-	-
	C	-	-	-	-	-	-
 F2-S	A	-	-	3 1/2" (89 mm) ◀	-	-	-
	B	-	-	1 3/8" (35 mm) ◀	-	-	-
	C	-	-	2 1/8" (54 mm) ◀	-	-	-
 F3-S	A	-	-	5 1/2" (140 mm) ◀	-	-	-
	B	-	-	1 3/8" (35 mm) ◀	-	-	-
	C	-	-	2 1/8" (54 mm) ◀	-	-	-
 F1-SS †††	A	-	-	2 15/16" (75 mm)	2 15/16" (75 mm) ◀	-	-
	B	-	-	-	-	-	-
	C	-	-	-	-	-	-
 F2-SS †††	A	-	-	3 1/2" (89 mm)	3 3/4" (95 mm)	-	-
	B	-	-	1 3/8" (35 mm)	1 3/8" (35 mm)	-	-
	C	-	-	2 1/8" (54 mm)	2 1/8" (54 mm)	-	-
 F3-SS †††	A	-	-	5 1/2" (140 mm)	5 1/2" (140 mm)	-	-
	B	-	-	1 3/8" (35 mm)	1 3/8" (35 mm)	-	-
	C	-	-	2 1/8" (54 mm)	2 1/8" (54 mm)	-	-
 F4-SS 2 1/2" swivel †††	A	-	-	-	3 13/16" (97 mm) ◀	-	-
	B	-	-	-	1 3/8" (35 mm) ◀	-	-
	C	-	-	-	2 1/8" (54 mm) ◀	-	-
 F5-SS 2 1/2" swivel †††	A	-	-	-	5 1/2" (140 mm)	-	-
	B	-	-	-	1 3/8" (35 mm)	-	-
	C	-	-	-	2 1/8" (54 mm)	-	-
 F12-SS †††	A	-	3 5/8" (93 mm) ◀	-	-	-	-
	B	-	1 25/64" (35 mm) ◀	-	-	-	-
	THREAD	-	2 1/2" NH (64 mm) ◀	-	-	-	-
 FE3-SS †††	A	-	-	7 1/8" (181 mm)	7 3/4" (197 mm) ◀	-	-
	B	-	-	1 3/8" (35 mm)	1 3/8" (35 mm) ◀	-	-
	C	-	-	2 1/8" (54 mm)	2 1/8" (54 mm) ◀	-	-
 FE6-SS †††	A	-	-	10 3/4" (273 mm) ◀	-	-	-
	B	-	-	1 3/8" (35 mm) ◀	-	-	-
	C	-	-	2 1/4" (57 mm) ◀	-	-	-











### Flex Hose, Solder & Victaulic Adapters

STYLE		SIZE								
		1" (25 mm)	1 1/2" (38 mm)	2" (51 mm)	2 1/2" (64 mm)	3" (76 mm)	3 1/2" (89 mm)	4" (102 mm)		
FLEX	 PI-SH	A	-	-	-	1 7/8" (48 mm)	1 15/16" (49 mm)	-	2 5/16" (59 mm)	
		B	-	-	-	-	-	-	-	
		C	-	-	-	-	-	-	-	
	 PI2-SH	A	-	-	-	-	1 15/16" (49 mm)	-	-	
		3" Adapter with 4" Flex Connection								
	 PA-SH	A	-	-	-	-	2 1/4" (57 mm) ◀	-	-	
		B	-	-	-	-	-	-	-	
		Angle	-	-	-	-	4°	-	-	
	 PO-SH	A	-	-	-	-	2 1/4" (57 mm) ◀	-	-	
		B	-	-	-	-	-	-	-	
		Angle	-	-	-	-	4° ◀	-	-	
	VICTAULIC	 VI-S	A	1 11/16" (43 mm) ◀	1 3/4" (44 mm)	1 29/32" (48 mm)	1 29/32" (48 mm)	2 3/32" (53 mm)	2 5/32" (53 mm)	2 1/4" (57 mm)
B			-	-	-	-	-	-	-	
C			-	-	-	-	-	-	-	
 * V3-S		A	-	3 5/16" (84 mm)	3 1/4" (83 mm)	3 3/16" (81 mm)	3 5/16" (84 mm)	-	4" (102 mm)	
		B	-	1 3/8" (35 mm)	1 3/8" (35 mm)	1 3/8" (35 mm)	1 3/8" (35 mm)	-	1 15/16" (49 mm)	
		C	-	-	-	-	-	-	-	
 * V4-S		A	-	-	-	3 1/2" (89 mm)	-	-	-	
		B	-	-	-	1 3/8" (35 mm)	-	-	-	
		C	-	-	-	2 1/8" (54 mm)	-	-	-	
2 1/2" (64 mm) with 3" (76 mm) Victaulic										
 ◊◊ VTI-S		A	-	-	-	-	2 5/32" (52 mm)	-	2 11/32" (60 mm) ◀	
		3" (76 mm) has 3" (76 mm) NPT + 4" (102 mm) Victaulic								
		4" (102 mm) has 4" (102 mm) NPT + 5" (127 mm) Victaulic								
 †† VE1-S * 2" *** 1 1/2"		A	-	-	3 3/4" (95 mm)	-	-	-	-	
		B	-	-	3" (76 mm)	-	-	-	-	
		C	-	-	-	-	-	-	-	
 *†† VE2-S		A	-	-	5 3/4" (146 mm) ◀	-	-	-	-	
		B	-	-	2 31/32" (75 mm) ◀	-	-	-	-	
	C	-	-	-	-	-	-	-		
 V20-SF For Flow Meter	A	-	-	3 3/16" (81 mm) ◀	3 3/16" (81 mm) ◀	4 1/4" (108 mm) ◀	-	-		
	B	-	-	1 1/4" (32 mm) ◀	1 1/4" (32 mm) ◀	1 5/8" (41 mm) ◀	-	-		
	THREAD	-	-	2" VIC (51 mm) ◀	2" VIC (51 mm) ◀	3" VIC (76 mm) ◀	-	-		
 ◊◊◊ V30-SCV	A	-	-	5 27/32" (148 mm)	6 1/4" (159 mm)	7 1/2" (191 mm)	-	-		
	B	-	-	3 7/8" (98 mm)	4 9/32" (109 mm)	4 15/16" (125 mm)	-	-		
	Built-in Check Valve									

KEY	
*	1/4" and 3/4" NPT taps
**	(2) 3/4" NPT taps
***	3/4" NPT tap
†	30° Angle
††	90° Angle
†††	Includes Strainer
+	Eccentric flange face
++	Slotted valve flange
+++	8 holes flange - Use 4
◊	(3) 3/4" NPT Taps
◊◊	Available in Cast or Chrome
#	For spacing only. 4 3/8" BCD each end.
##	For use when replacing a 7840 with an 8840. Each adapter is 1" thick.
###	(2) 3/4" NPT Taps and (1) 1" NPT Tap
◀	Non-standard items. May have longer lead times.

## Pump Flange Adapters (Hale Pump Use)

KEY	
*	1/4" and 3/4" NPT taps
**	(2) 3/4" NPT taps
***	3/4" NPT tap
†	30° Angle
††	90° Angle
†††	Includes Strainer
+	Eccentric flange face
++	Slotted valve flange
+++	8 holes flange - Use 4
◊	(3) 3/4" NPT Taps
◊◊	Available in Cast or Chrome
#	For spacing only. 4 3/8" BCD each end.
##	For use when replacing a 7840 with an 8840. Each adapter is 1" thick.
###	(2) 3/4" NPT Taps and (1) 1" NPT Tap
◀	Non-standard items. May have longer lead times.





STYLE	SIZE						
	2 1/2" (64 mm)	3" / 3 1/2" (76/89 mm)	4" (102 mm)	ANGLE	BOLT HOLES	BOLT CIR. DIA.	
 B1-SE	A	-	2 7/8" (73 mm)	-	-	8	5 3/4" (146 mm)
	B	-	-	-	-	-	-
	C	-	-	-	-	-	-
 + B2-SE	A	-	2 7/8" (73 mm)	-	26°	8	5 3/4" (146 mm)
	B	-	-	-	-	-	-
	C	-	-	-	-	-	-
 B3-SE	A	-	3 1/8" (79 mm)	-	3°30'	8	5 3/4" (146 mm)
	B	-	-	-	-	-	-
	C	-	-	-	-	-	-
 B6-SE	A	-	6 7/8" (175 mm) ◀	-	4°	8	5 3/4" (146 mm)
	B	-	-	-	-	-	-
	C	-	-	-	-	-	-
 B8-SH (Octagonal Flange)	A	-	-	4"	-	8	5 3/4" (146 mm)
	B	-	-	-	-	-	-
	C	-	-	-	-	-	-
 B20-SFH	A	-	-	5 27/64" (138 mm) ◀	-	8	5 3/4" (146 mm)
	B	-	-	2 43/64" (68 mm) ◀	-	-	-
	For Flow Meter						
 ++ HD1-S	A	6 1/4" (159 mm)	5 3/4" (146 mm)	-	-	4	4 3/8" (111 mm)
	B	-	-	-	-	-	-
	Angle	5°20'	7°	-	-	-	-
 ++ HD2-S	A	8 1/4" (210 mm)	7 3/4" (197 mm)	-	-	4	4 3/8" (111 mm)
	B	-	-	-	-	-	-
	Angle	3°45'	4°	-	-	-	-
 HD4-S	A	5 1/4" (133 mm) ◀	-	-	14°5'	4	4 3/8" (111 mm)
	B	-	-	-	-	-	-
	C	-	-	-	-	-	-













### Pump Flange Adapters (Hale Pump Use) ...Continued









STYLE	SIZE						
	2 1/2" (64 mm)	3"/3 1/2" (76/89 mm)	4" (102 mm)	ANGLE	BOLT HOLES	BOLT CIR. DIA.	
 ++ HD21-SF UP or DN For Flow Meter	A	6 1/4" (159 mm) ◀	-	-	5°20'	4	4 3/8" (111 mm)
	B	3 1/8" (79 mm) ◀	-	-	-	-	-
	C	-	-	-	-	-	-
 ++ SE1-S	A	3 1/4" (83 mm)	2 3/4" (70 mm) ◀	-	90°	4	4 3/8" (111 mm)
	B	5 1/4" (133 mm)	6" (152 mm) ◀	-	-	-	-
	C	-	-	-	-	-	-
 ++ SE2-S	A	5 1/4" (133 mm)	4 3/4" (121 mm) ◀	-	90°	4	4 3/8" (111 mm)
	B	5 1/4" (133 mm)	6" (152 mm) ◀	-	-	-	-
	C	-	-	-	-	-	-
 ++ SE3-S	A	2 1/2" (64 mm)	-	-	90°	4	4 3/8" (111 mm)
	B	7 3/4" (197 mm)	-	-	-	-	-
	C	-	-	-	-	-	-
 SE4-S	A	8.5" (216 mm) ◀	-	-	-	4	4 3/8" (111 mm)
	B	6" (152 mm) ◀	-	-	-	-	-
	C	-	-	-	-	-	-

KEY	
*	1/4" and 3/4" NPT taps
**	(2) 3/4" NPT taps
***	3/4" NPT tap
†	30° Angle
††	90° Angle
†††	Includes Strainer
+	Eccentric flange face
++	Slotted valve flange
+++	8 holes flange - Use 4
◊	(3) 3/4" NPT Taps
◊◊	Available in Cast or Chrome
#	For spacing only. 4 3/8" BCD each end.
##	For use when replacing a 7840 with an 8840. Each adapter is 1" thick.
###	(2) 3/4" NPT Taps and (1) 1" NPT Tap
◀	Non-standard items. May have longer lead times.

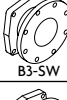
### Pump Flange Adapters (Waterous Pump Use)

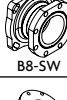
STYLE	SIZE							
	2" (51 mm)	2 1/2" (64 mm)	3"/3 1/2" (76/89 mm)	4" (102 mm)	ANGLE	BOLT HOLE	BOLT CIR. DIA.	
 B1-S	A	2 5/8" (67 mm)	2 5/8" (67 mm)	2 7/8" (73 mm)	-	4 (8 on 2")	4 3/8" (111 mm)	
	B	-	-	-	-	-	-	
	C	-	-	-	-	-	-	
 B1-SX	A	-	2 5/8" (67 mm)	-	-	4 slots	4 3/8" (111 mm)	
	B	-	-	-	-	-	-	
	C	-	-	-	-	-	-	
 +++ B4-S	A	-	2 5/8" (67 mm)	2 7/8" (73 mm) ◀	-	8	4 3/8" (111 mm)	
	B	-	-	-	-	-	-	
	C	-	-	-	-	-	-	
 B5-S	A	-	4 5/8" (117 mm)	-	-	4 slots & 4 holes	4 3/8" (111 mm)	
	A	-	-	4 1/2" (114 mm)	-	-	4 slots	4 3/8" (111 mm)
	B	-	-	-	-	-	-	
 +++ B6-S	A	-	6" (152 mm)	-	-	8	4 3/8" (111 mm)	
	B	-	-	-	-	-	-	
	C	-	-	-	-	-	-	
 B7-S	A	-	5.5" (140 mm) ◀	-	-	4 slots & 4 holes	4 3/8" (111 mm)	

## Pump Flange Adapters (Waterous Pump Use) ...Continued

STYLE		SIZE						
		2" (51 mm)	2 1/2" (64 mm)	3 1/2" (76/89 mm) 76/89 mm	4" (102 mm)	ANGLE	BOLT HOLE	BOLT CIR. DIA.
 B3-SH	A	-	-	13/16" - 1 1/32" (21-34 mm)	-	4°	4	7 25/32" (198 mm)
	B	-	-	-	-	-	-	-
	C	-	-	-	-	-	-	-
 B3-SH (4")	A	-	-	-	2" Total (51 mm) ◀	4°	4	7 25/32" (198 mm)
	B	-	-	-	-	-	-	-
	C	-	-	-	-	-	-	-
 + B2-SW	A	-	-	2 7/8" (73 mm)	-	26°	8	5 1/2" (140 mm)
	B	-	-	-	-	-	-	-
	C	-	-	-	-	-	-	-
 B3-SW	A	-	-	3 1/8" (79 mm)	-	4°	8	5 1/2" (140 mm)
	B	-	-	-	-	-	-	-
	C	-	-	-	-	-	-	-
 B4-SW	A	-	-	5" (127 mm) ◀	-	4°	8	5 1/2" (140 mm)
	B	-	-	-	-	-	-	-
	C	-	-	-	-	-	-	-
 B8-SW	A	-	-	-	4" (102 mm)	-	8	5 1/2" (140 mm)
	B	-	-	-	-	-	-	-
	C	-	-	-	-	-	-	-
 +++ B1-SEW	A	-	-	2 7/8" (73 mm)	-	-	8 slots	5 1/2" (140 mm)
	B	-	-	-	-	-	-	-
	C	-	-	-	-	-	-	-
 WDE1-S	A	-	-	4 9/16" (112 mm) ◀	-	90°	8	5 1/2" (140 mm)
	B	-	-	4 5/16" (110 mm) ◀	-	-	-	-
	C	-	-	-	-	-	-	-
 WDE94-S	A	-	-	-	9 1/2" (241 mm) ◀	94°	8	5 1/2" (140 mm)
	B	-	-	-	5" (127 mm) ◀	-	-	-
	C	-	-	-	-	-	-	-



## Valve Dimension Key

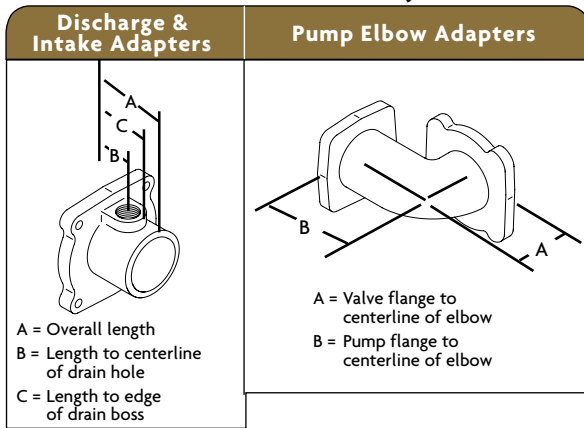

KEY	
*	1/4" and 3/4" NPT taps
**	(2) 3/4" NPT taps
***	3/4" NPT tap
†	30° Angle
††	90° Angle
†††	Includes Strainer
+	Eccentric flange face
++	Slotted valve flange
+++	8 holes flange - Use 4
◇	(3) 3/4" NPT Taps
◇◇	Available in Cast or Chrome
#	For spacing only. 4 3/8" BCD each end.
##	For use when replacing a 7840 with an 8840. Each adapter is 1" thick.
###	(2) 3/4" NPT Taps and (1) 1" NPT Tap
◀	Non-standard items. May have longer lead times.

## Pump Flange Adapters General Use

STYLE		SIZE				
		2" (51 mm)	4" (102 mm)	ANGLE	BOLT HOLE	BOLT CIR. DIA.
 +++ DE1-S	A	3 3/4" (95 mm)	-	90°	8	4 3/8" (111 mm)
	B	4 13/16" (122 mm)	-	-	-	-
	C	-	-	-	-	-
 +++ DE2-S	A	3 3/4" (95 mm)	-	90°	8	4 3/8" (111 mm)
	B	5 1/2" (140 mm)	-	-	-	-
	C	-	-	-	-	-

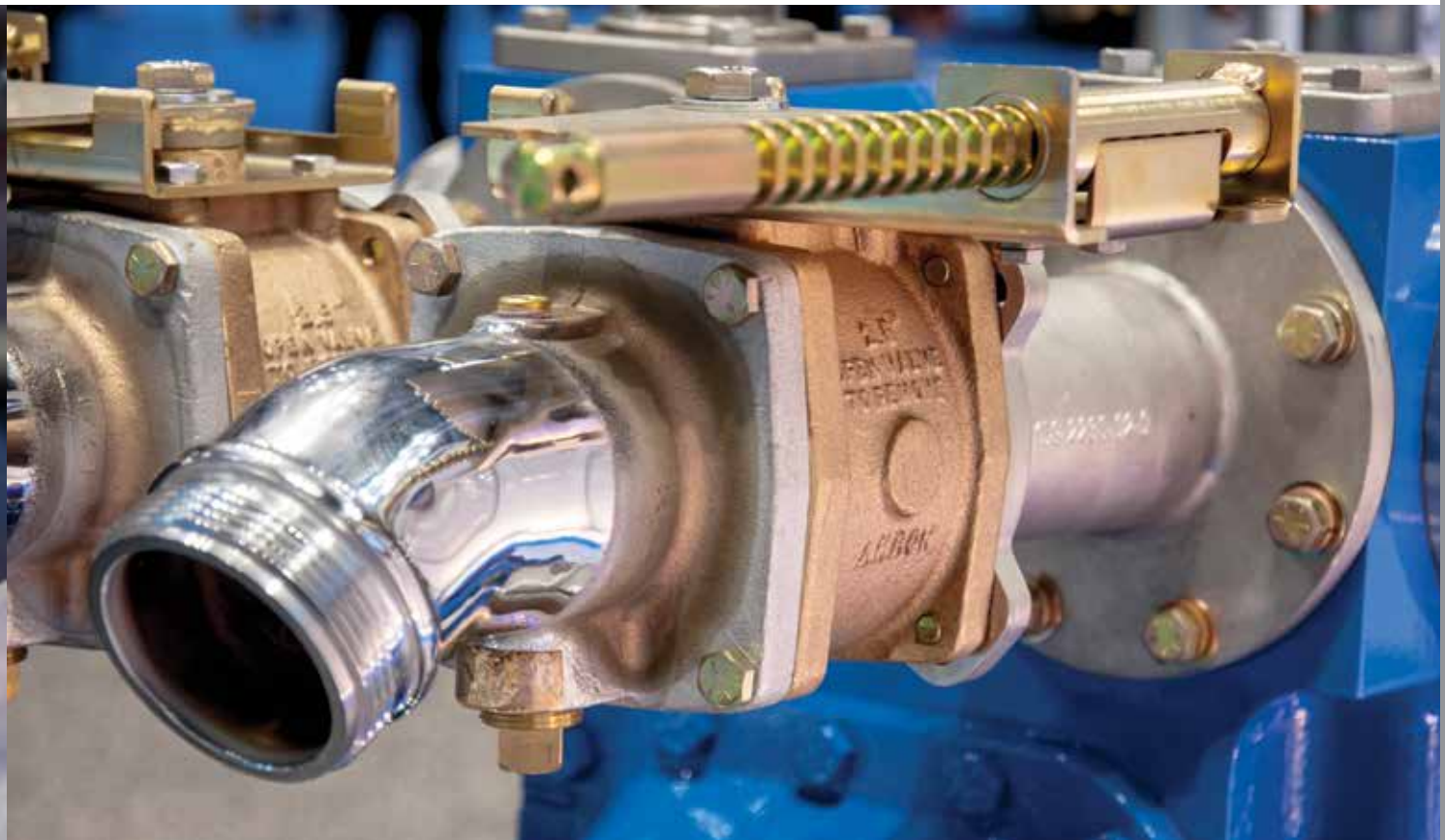



## PRODUCT SERVICE CENTER

Akron® provides a full time staff ready to service products. To submit your request for product repair, visit [onlinerepair.akronbrass.com](http://onlinerepair.akronbrass.com) or call Customer Care at 330.264.5678 (800.228.1161) for estimates and shipping instructions.



STYLE	DESCRIPTION	SERVICE KIT
708	Imperial, Spitz, Ball Shutoff and Marauder	9150
709	Imperial, Spitz, Ball Shutoff and Marauder	9150
710	Imperial, Spitz, Ball Shutoff and Marauder	9150
753	Trigger Shutoff	9161
810	1" Ball Valve	9124
815	1 1/2" Ball Valve, Wye & Water Thief	9125
820	2" Valve	9126
825	2 1/2" Valve, Wye & Siamese (2 1/4" Waterway)	9127
828	2 1/2" Valve, 2 1/2" Water Thief, Wye, Hydrant Valve	9128
830	3" Valve	9129
904	Imperial, Spitz, Ball Shutoff and Marauder	9150
905	Imperial, Spitz, Ball Shutoff and Marauder	9150
908	Imperial, Spitz, Ball Shutoff and Marauder	9150
911	Ozzie	9191
922	OzzieMaster	9292
1110	Imperial, Spitz, Ball Shutoff and Marauder	9150
1115	Brass Shutoff	9151
1125	Brass Shutoff	9152
1128	Brass Shutoff	9152
1390	Playpipe	9152
1480	Wye	9125
1481	Wye	9125
1482	2 1/2" Valve, Wye & Siamese	9127
1483	2 1/2" Valve, Wye & Siamese	9127
1512	SaberJet	9183
1513	SaberJet	9183
1515	SaberJet	9183
1520	SaberJet	9183
1522	SaberJet	9182
1523	SaberJet	9182
1525	SaberJet	9182
1526	SaberJet	9182
1527	SaberJet	9182
1528	SaberJet	9182
1532	SaberJet	9184
1533	SaberJet	9184
1535	SaberJet	9184
1536	SaberJet	9184
1573	Water Thief	9125
1573	2 1/2" Valve, 2 1/2" Water Thief, Wye, Hydrant Valve	9128
1581	Wye	9125
1582	2 1/2" Valve, 2 1/2" Water Thief, Wye, Hydrant Valve	9128
1583	2 1/2" Valve, 2 1/2" Water Thief, Wye, Hydrant Valve	9128
1601	1" ProVenger	9112
1602	1" ProVenger	9112
1615	1 1/2" ProVenger	9111
1616	1 1/2" ProVenger	9111
1701	1" - 1 1/2" Turbojet & Marauders w/ Spinning Teeth	9108
1701	1" Turbojet & Marauder	9115

STYLE	DESCRIPTION	SERVICE KIT
1701	Turbojet (2000-Current)	9180
1702	1" - 1 1/2" Turbojet & Marauders w/ Spinning Teeth (1/2" Ball)	9106
1702	1" Turbojet & Marauder (1" Ball)	9115
1702	Turbojet (2000-Current)	9180
1704	Turbojet	9180
1708	1" Turbojet	9106
1710	1" Turbojet	9106
1715	1" - 1 1/2" Turbojet & Marauders w/ Spinning Teeth	9108
1716	1" - 1 1/2" Turbojet & Marauders w/ Spinning Teeth	9108
1720	1" - 1 1/2" Turbojet & Marauders w/ Spinning Teeth	9108
1722	2 1/2" Turbojet, Akromatic, & Marauder Nozzles	9110
1723	2 1/2" Turbojet, Akromatic, & Marauder Nozzles	9110
1725	2 1/2" Turbojet, Akromatic, & Marauder Nozzles	9110
1729	2 1/2" Turbojet, Akromatic, & Marauder Nozzles	9110
1741	Industrial Turbojet	9515
1762	Wide-Range Turbojet	9179
1763	Wide-Range Turbojet	9179
1828	2 1/2" Valve, 2 1/2" Water Thief, Wye, Hydrant Valve	9128
2032	1 1/2" Navy Nozzle	9163
2046	2 1/2" Coast Guard Nozzle	9164
2069	1 1/2" Navy Nozzle	9163
2074	2 1/2" Navy Nozzle	9164
2079	1 1/2" Military Nozzle	9163
2084	2 1/2" Military Nozzle	9164
2101	Pyrolite® Shutoff	9115
2110	Pyrolite Shutoff	9150
2111	Pyrolite Shutoff	9150
2130	Pyrolite Shutoff Pre 2005	9158
2115	Pyrolite Shutoff	9151
2116	Pyrolite Shutoff	9151
2125	Pyrolite Shutoff	9152
2126	Pyrolite Shutoff	9152
2127	Pyrolite Shutoff	9152
2129	Pyrolite Shutoff	9152
2130	Pyrolite Shutoff	9159
2390	Playpipe	9152
2430	Saber Shutoff	9152
2431	Saber Shutoff	9152
2432	Saber Shutoff	9152
2433	Saber Shutoff	9152
2580	Wye	9153
2581	Wye	9153
2582	2 1/2" Valve, 2 1/2" Water Thief, Wye, Hydrant Valve	9128
2583	2 1/2" Valve, 2 1/2" Water Thief, Wye, Hydrant Valve	9128
2629	2 1/2" Turbojet, Akromatic, & Marauder Nozzles	9110
2630	2 1/2" Turbojet, Akromatic, & Marauder Nozzles	9110
2681	Wye	9153
3015	1 1/2" Brass Fog Nozzle	9155
3016	1 1/2" Brass Fog Nozzle	9155
3019	1 1/2" Brass Fog Nozzle	9155
3021	1 1/2" Brass Fog Nozzle	9155
3025	Brass Fog Nozzle	9110
3352	Tuckaway Bumper Turret	9192
3353	Tuckaway Bumper Turret	9192
3367	Turret with Brass Inlet	9193
3411	Apollo Spikes	9190
3414	Apollo	9189
3416	Apollo	9189
3416	Apollo Spikes	9190
3421	Apollo Spikes	9190
3421	Apollo	9189
3423	Apollo	9189
3425	Aries Monitor	9525
3423	Apollo Spikes	9190
3427	3" Apollo w/Gas Spring	9527
3430	GP Manual	9438
3431	Apollo Spikes	9190
3433	Apollo Spikes	9190
3436	4" Apollo Monitor	9437
3437	4" Omega Monitor	9437
3440	DeckMaster Position Feedback	9540
3443	Mercury with updated inlet	9130
3443	Spikes	9443
3446	Valve	9131
3460	Turret	9170
3460	Turret	9170
3461	Turret	9171
3462	Forestry Multi Purpose	9223
3463	FireFox for position feedback	9263
3465	Turret (95-300 gpm)	9195
3466	Turret (95-300 gpm)	9196



STYLE	DESCRIPTION	SERVICE KIT
3467	Turret Upgrade Kit with Brass Inlet	9193
3467	Roof Turret Valve	9194
3467	Turret Waterway	9197
3467	Roof Turret Valve with Pyrolite Inlet	9198
3467	Roof Turret Headliner Label Kit	9199
3480	Stream Master II	9220
3481	Stream Master II	9220
3482	Stream Master II	9220
3483	Stream Master II	9220
3524	Omega Severe-Duty	9524
3526	Omega	9526
3527	3" Omega w/Gas Spring	9527
3528	Omega XP	9528
3578	Stream Master and Stream Master XT	9221
3579	Stream Master and Stream Master XT	9221
3715	1 1/2" Industrial Turbojet	9108
3716	1 1/2" Industrial Turbojet	9515
3718	1 1/2" Industrial Turbojet	9515
3719	1 1/2" Industrial Turbojet	9515
3720	1 1/2" Industrial Turbojet	9108
3721	1 1/2" Industrial Turbojet	9515
3725	Industrial Turbojet	9110
4102	1" ProVenger	9112
4115	1 1/2" ProVenger	9111
4116	1 1/2" ProVenger	9111
4308	Imperial, Spitz, Ball Shutoff and Marauder	9150
4310	Imperial, Spitz, Ball Shutoff and Marauder	9150
4507	1" Marauder	9151
4508	1" Marauder	9151
4510	1" Marauder	9150
4511	1" Marauder	9150
4512	1 1/2" Marauder	9151
4513	1 1/2" Marauder	9151
4515	1 1/2" Marauder	9151
4516	1 1/2" Marauder	9151
4525	2 1/2" Marauder	9152
4526	2 1/2" Marauder	9152
4529	2 1/2" Marauder	9152
4530	2 1/2" Marauder	9152
4612	1" Marauder	9108
4613	1" Marauder	9108
4615	1 1/2" Marauder	9108
4616	1 1/2" Marauder	9108
4625	2 1/2" Turbojet, Akromatic, & Marauder Nozzles	9110
4626	2 1/2" Turbojet, Akromatic, & Marauder Nozzles	9110
4629	Marauder	9110
4630	Marauder	9110
4712	1" Assault (Pre-2005)	9178
4712	1" Assault (2005-Current)	9179
4713	1" Assault (Pre-2005)	9178
4713	1" Assault (2005-Current)	9179
4715	1 1/2" Assault (Pre-2005)	9178
4715	1 1/2" Assault (2005-Current)	9179
4720	1 1/2" Assault (Pre-2005)	9178
4720	1 1/2" Assault (2005-Current)	9179
4801	1" Assault	9180
4802	1" Assault	9180
4812	1" Assault (Pre-2005)	9178
4812	1" Assault (2005-Current)	9179
4813	1" Assault (Pre-2005)	9178
4813	1" Assault (2005-Current)	9179
4815	1 1/2" Assault (Pre 2005)	9178
4815	1 1/2" Assault (2005 - Current)	9179
4820	1 1/2" Assault (Pre 2005)	9178
4820	1 1/2" Assault (2005 - Current)	9179
4822	1 1/2" High-Range Assault	9179
4823	1 1/2" High-Range Assault	9179
4825	2 1/2" High-Range Assault	9179
4826	2 1/2" High-Range Assault	9179
4862	Mid-Range Assault	9179
4863	Mid-Range Assault	9179
5015	Mid-Range Akromatic®	9152
5016	Mid-Range Akromatic	9152
5020	Mid-Range Akromatic	9152
5021	Mid-Range Akromatic	9152
5115	1 1/2" Mid-Range Akromatic Nozzle	9160
5116	1 1/2" Mid-Range Akromatic Nozzle	9160
5120	1 1/2" Mid-Range Akromatic Nozzle	9160
5121	1 1/2" Mid-Range Akromatic Nozzle	9160

STYLE	DESCRIPTION	SERVICE KIT
5125	Akromatic II	9152
5126	Akromatic II	9152
5127	Akromatic II	9152
5128	Akromatic II	9152
5135	Akromatic II	9152
5136	Akromatic II	9152
5137	Akromatic II	9152
5138	Akromatic II	9152
5177	Akromatic 1250	9077
5225	2 1/2" Turbojet, Akromatic, & Marauder Nozzles	9110
5226	2 1/2" Turbojet, Akromatic, & Marauder Nozzles	9110
5227	2 1/2" Turbojet, Akromatic, & Marauder Nozzles	9110
5228	2 1/2" Turbojet, Akromatic, & Marauder Nozzles	9110
5235	2 1/2" Turbojet, Akromatic, & Marauder Nozzles	9110
5236	2 1/2" Turbojet, Akromatic, & Marauder Nozzles	9110
5237	2 1/2" Turbojet, Akromatic, & Marauder Nozzles	9110
5238	2 1/2" Turbojet, Akromatic, & Marauder Nozzles	9110
7610	1" Swing-Out Valve Kit Less Ball	9208
7610	1" Swing-Out Valve with Polymer Ball	8903
7615	1 1/2" Swing-Out Valve Kit Less Ball	9209
7615	1 1/2" Swing-Out Valve with Polymer Ball	8904
7620	2" Swing-Out Valves with Polymer Ball	8905
7620	2" Swing-Out Valves Kit Less Ball	9204
7625	2 1/2" Swing-Out Valves with Polymer Ball	8906
7625	2 1/2" Swing-Out Valves Kit Less Ball	9205
7630	3" & 3 1/2" Swing-Out Valves with Polymer Ball	8907
7630	3" & 3 1/2" Swing-Out Valves Kit Less Ball	9205
7635	3" & 3 1/2" Swing-Out Valves with Polymer Ball	8907
7635	3" & 3 1/2" Swing-Out Valves Kit Less Ball	9147
7810	1" Swing-Out Valve Kit Less Ball	9208
7810	1" Swing-Out Valve with Polymer Ball	8903
7815	1 1/2" Swing-Out Valve Kit Less Ball	9209
7815	1 1/2" Swing-Out Valve with Polymer Ball	8904
7820	2" Swing-Out Valves with Polymer Ball	8905
7820	2" Swing-Out Valves Kit Less Ball	9204
7825	2 1/2" Swing-Out Valves with Polymer Ball	8906
7825	2 1/2" Swing-Out Valves Kit Less Ball	9205
7830	3" & 3 1/2" Swing-Out Valves with Polymer Ball	8907
7830	3" & 3 1/2" Swing-Out Valves Kit Less Ball	9206
7835	3" & 3 1/2" Swing-Out Valves with Polymer Ball	8907
7835	3" & 3 1/2" Swing-Out Valves Kit Less Ball	9206
7840	4" Heavy Duty Swing-Out Valve with Polymer Ball	8908
7980	Black Max™	9168
7982	Revolution™	9169
7983	Revolution™	9169
8620	2" Valve Kit Less Ball	9204
8620	2" Swing-Out Valves with Metal Ball	9145
8625	2 1/2" Valve Kit Less Ball	9205
8625	3 1/2" Swing-Out Valves with Metal Ball	9146
8630	3" & 3 1/2" Swing-Out Valves with Metal Ball	9147
8630	3" & 3 1/2" Valve Kit Less Ball	9206
8635	3" & 3 1/2" Swing-Out Valves with Metal Ball	9147
8635	3" & 3 1/2" Valve Kit Less Ball	9206
8810	1" Swing-Out Valve with Metal Ball	8803
8810	1" Valve Kit Less Ball	9208
8815	1 1/2" Swing-Out Valve with Metal Ball	8804
8815	1 1/2" Valve Kit Less Ball	9209
8820	2" Valve Kit Less Ball	9204
8820	2" Swing-Out Valves with Metal Ball	9145
8825	2 1/2" Swing-Out Valves with Metal Ball	9146
8825	2 1/2" Valve Kit Less Ball	9205
8830/35	3" & 3 1/2" Swing-Out Valves with Metal Ball	9147
8830/35	3" & 3 1/2" Valve Kit Less Ball	9206
8840	4" Swing-Out Valve	9166
8840	Hi-Cycle 4" Swing-Out Valve	9167
8910	1" Swing-Out Valve with Polymer Ball	8903
8910	1" Valve Kit Less Ball	9208
8915	1 1/2" Swing-Out Valve with Polymer Ball	8904
8915	1 1/2" Valve Kit Less Ball	9209
8920	2" Swing-Out Valves with Polymer Ball	8905
8920	2" Valve Kit Less Ball	9204
8925	2 1/2" Swing-Out Valves with Polymer Ball	8906
8925	2 1/2" Valve Kit Less Ball	9205
8930	3" & 3 1/2" Swing-Out Valves with Polymer Ball	8907
8930	3" & 3 1/2" Valve Kit Less Ball	9206
8935	3" & 3 1/2" Swing-Out Valves with Polymer Ball	8907
8935	3" & 3 1/2" Valve Kit Less Ball	9206
8940	4" Heavy Duty Swing-Out Valve	8908
9015	9015 Pitot Blade	9015

**Municipal Electric Monitors**

Monitor \ Nozzle	3293 FireFox Low	3293 FireFox Med	3293 FireFox High	3292 UHP	5075 Akromatic 1250	5177 Akromatic 1000	5178 Akromatic 2000	4040 Akrochem	4042 Akrochem	SaberMaster 1578	4480	5088 Renegade (automatic)	2188 Renegade (fixed)	2189 Renegade (adjustable)
3356 Trident					✓	✓	✓	✓	✓	✓	✓			
3419 Apollo PE			✓		✓	✓				✓	✓			
3440 DeckMaster			✓		✓	✓		✓		✓	✓			
3450 UHP				✓										
3462 Forestry	✓	✓												
3463 FireFox	✓	✓	✓					*						
3479 Gemini			✓		✓	✓				✓	✓			
3480 StreamMaster II					✓	✓	✓	✓	✓	✓	✓			
3482 StreamMaster II			✓		✓	✓		✓		✓	✓			
3491 Severe Duty			✓											
3578 StreamMaster					✓	✓	✓		✓	✓	✓			
3580 Renegade												✓	✓	✓

\* Requires 3463 with 2.5" outlet and 4040 250-500 versions

**Municipal Manual Monitors**

Monitor \ Nozzle	0487 Tip	0489 Straight Tip	2498 Stack Tip	2499 Stack Tip	3499 Stack Tip	5147 Excel 1000	4445 Mercury	4447 Mercury	1545 SaberMaster	4452 Aquastream	5150 Mercury	1745 Turbomaster	1757 Turbomaster	4475 Akrofoam	1755 Turbomaster	5160 Akromatic	4039 Akrochem	4041 Akrochem	5170 Akromatic	
1495 Ladder Pipe	✓	✓	✓	✓		✓	✓	✓	✓	✓	✓	✓	✓	✓	✓	✓				
1496 Ladder Pipe	✓	✓	✓	✓		✓	✓	✓	✓	✓	✓	✓	✓	✓	✓	✓				
3414 Apollo	✓	✓	✓	✓		✓	✓	✓	✓	✓	✓	✓	✓	✓	✓	✓	✓			
3416 Apollo	✓	✓	✓	✓		✓	✓	✓	✓	✓	✓	✓	✓	✓	✓	✓	✓			
3421 Apollo	✓	✓	✓	✓		✓	✓	✓	✓	✓	✓	✓	✓	✓	✓	✓	✓			
3423 Apollo	✓	✓	✓	✓		✓	✓	✓	✓	✓	✓	✓	✓	✓	✓	✓	✓			
3426 Apollo	✓	✓	✓	✓		✓	✓	✓	✓	✓	✓	✓	✓	✓	✓	✓	✓			
3430 GP Manual	✓	✓	✓	✓		✓	✓	✓	✓	✓	✓	✓	✓	✓	✓	✓	✓			
3431 Apollo Hi-Riser	✓	✓	✓	✓		✓	✓	✓	✓	✓	✓	✓	✓	✓	✓	✓	✓			
3433 Apollo Hi Riser	✓	✓	✓	✓		✓	✓	✓	✓	✓	✓	✓	✓	✓	✓	✓	✓			
3470 Gemini	✓	✓	✓	✓		✓	✓	✓	✓	✓	✓	✓	✓	✓	✓	✓	✓			
3481 StreamMaster II					✓													✓		✓

Yellow indicates that the selected monitor cannot use the entire flow range of this nozzle





# Technical Data: Compatibility Chart



## Industrial Hydraulic & Electric Monitors

Monitor \ Nozzle	0489 Straight Tip	4462 Rampage	4471 Akrofoam	5055 Akromatic	2155 Black Widow	2156 Black Widow	5056 Akromatic	4472 Akrofoam (hydraulic)
3476 Gemini Brass HYD						✓	✓	✓
3491 Severe Duty ELECT	✓	✓	✓					
3492 Severe Duty HYD						✓	✓	✓

## Industrial Manual Monitors

Monitor \ Nozzle	0489 Straight Tip	4450 Aquastream	4460 Rampage	4461 Rampage	5161 Akromatic	4470 Akrofoam	2171 Masterstream	5071 Akromatic
3437 Omega 2000							✓	✓
3523 Omega XPV	✓	✓	✓	✓	✓	✓		
3524 Omega SD	✓	✓	✓	✓	✓	✓		
3525 Aries	✓	✓	✓	✓	✓	✓		
3526 Omega 1250	✓	✓	✓	✓	✓	✓		
3528 Omega XP	✓	✓	✓	✓	✓	✓		
3671 Conquest							✓	✓
3690 Storm							✓	✓

■ Yellow Indicates that a thread adapter is needed for this combination

## Portable Monitors

Monitor \ Nozzle	1744/1727 Turbojet	4824/4827 Assault	0489 Straight Tip	2420 Stack Tips	2498 Stack Tips	4445 Mercury	4447 Mercury	1545 Mercury	1745 Turbomaster	1757 Turbomaster	1755 Turbomaster	5147 Mercury	5150 Mercury	5160 Akromatic	5148 Mercury
0911 Ozzie	✓	✓													
0922 Ozzie Master			✓	✓	✓	✓	✓	✓	✓	✓	✓	✓	✓	✓	
3443 Mercury			✓	✓		✓	✓	✓							✓
3446 Mercury Master			✓		✓	✓	✓	✓				✓	✓		✓







UltraJet® Smooth Bore and Fog Flow Reach																
Tip Size	Inlet Pressure		Smooth Bore Flow Narrow Fog Flow Wide Fog Flow		Smooth Bore Reach				Fog Reach							
	PSI	Bar	GPM	LPM	Effective		Overall		Narrow Fog				Full Fog			
					Feet	Meters	Feet	Meters	Effective		Overall		Effective		Overall	
	Feet	Meters	Feet	Meters	Feet	Meters	Feet	Meters	Feet	Meters	Feet	Meters	Feet	Meters	Feet	Meters
3/4"	50	3.5	118	447	113	35	126	38	41	13	46	14	14	4	15	5
7/8"	50	3.5	161	609	122	37	136	41	45	14	50	15	14	4	15	5
1 1/16"	50	3.5	184	700	127	39	141	43	40	12	44	13	14	4	15	5
1"	50	3.5	210	795	126	38	140	43	40	12	44	13	16	5	18	5
3/4"	75	5	145	549	133	41	148	45	49	15	54	16	18	5	20	6
7/8"	75	5	197	746	143	44	159	48	52	16	58	18	18	5	20	6
1 1/16"	75	5	226	855	149	46	166	51	44	13	49	15	19	6	21	6
1"	75	5	257	973	154	47	171	52	47	14	52	16	19	6	21	6
3/4"	87	6	156	590	140	43	155	47	51	16	57	17	22	7	24	7
7/8"	87	6	212	802	150	46	167	51	57	17	63	19	21	6	23	7
1 1/16"	87	6	243	924	151	46	168	51	50	15	56	17	21	6	23	7
1"	87	6	277	1048	153	47	170	52	50	15	56	17	21	6	23	7
3/4"	100	7	167	632	146	44	162	49	57	17	63	19	23	7	26	8
7/8"	100	7	227	859	149	45	165	50	58	18	64	20	23	7	25	8
1 1/16"	100	7	261	988	158	48	176	54	54	16	60	18	24	7	27	8
1"	100	7	297	1124	154	47	171	52	52	16	58	18	24	7	27	8

\*Reach figures are measured with nozzle at 32 degrees above horizontal. Effective reach is considered the farthest portion of the water droplet footprint where firefighting can be accomplished, in still conditions. Overall reach is considered where farthest droplets of water fall, in still conditions. Actual results will vary depending on operation, environmental and maintenance conditions.

ProVenger Nozzles Rated at 87 PSI				
Style	Nozzle Pressure		Flow	
	PSI	BAR	GPM	LPM
1602	75	5	11	42
			21	80
			32	121
			48	182
	87	6	12	45
			23	85
			34	130
			52	200
	100	7	13	49
			25	95
			36	136
			56	212
1602	75	5	5	19
			9	34
			19	72
			37	140
	87	6	5	19
			10	40
			20	75
			40	150
	100	7	5	19
			11	42
			21	80
			43	163
1616, 4116	75	5	28	106
			56	212
			88	333
			116	439
	87	6	30	115
			60	230
			95	360
			125	475
	100	7	150	550
			32	121
			64	242
			102	386
100	7	134	508	
		161	610	

ProVenger Nozzles Rated at 100 PSI				
Style	Nozzle Pressure		Flow	
	PSI	BAR	GPM	LPM
1602	50	3	4	15
			7	26
			14	53
			28	106
	75	5	4	15
			9	34
			17	64
			35	132
	100	7	5	19
			10	40
			20	75
			40	150
125	8	6	23	
		11	42	
		22	83	
		45	170	
1616, 4116	50	3	21	80
			42	159
			67	254
			88	333
	75	5	106	402
			26	98
			52	197
			82	310
	100	7	108	409
			130	492
			30	115
			60	230
125	8	95	360	
		125	475	
		150	550	
		34	129	
125	8	67	254	
		106	401	
		140	530	
		168	636	



Turbojet™ Nozzles Rated At 100 Psi										
Style	Nozzle Pressure		Flow Setting		Actual Flow		Straight Stream Reach*			
	PSI	BAR	GPM	LPM	GPM	LPM	Effective		Overall	
							FEET	METERS	FEET	METERS
1701, 1702 1703	75	5	13	50	11	42	50	15	60	18
			25	95	22	83	60	18	70	21
			40	150	35	132	77	23	87	26
			60	230	52	197	100	30	110	34
			13	50	13	50	57	17	67	20
			25	95	25	95	64	20	74	23
	100	7	40	150	40	150	90	27	100	30
			60	230	60	230	110	34	120	37
			13	50	15	57	57	17	67	20
			25	95	28	106	67	20	77	23
			40	150	45	170	97	30	107	33
			60	230	67	254	120	37	130	40
1714, 1715 1717, 1720	75	5	30	115	26	98	80	24	90	27
			60	230	52	197	107	33	117	36
			95	360	82	310	127	39	137	42
			125	475	108	409	130	40	146	45
	100	7	30	115	30	115	85	26	95	29
			60	230	60	230	115	35	125	38
			95	360	95	360	135	41	145	44
			125	475	125	475	140	43	150	46
	125	8.5	30	115	34	129	97	30	107	33
			60	230	67	254	120	37	130	40
			95	360	106	401	145	44	155	47
			125	475	140	530	150	46	160	49
1722, 1723 1724, 1737 (95-200 gpm)  1762, 1763 1766, 1767 (3-200 gpm)  1725, 1727 1729, 1733 1744 (125-250 gpm)	75	5	30	115	26	98	75	23	85	26
			95	360	82	310	117	36	127	39
			125	475	108	409	127	39	137	42
			150	550	130	492	145	44	155	47
			200	750	173	654	160	49	170	52
			250	950	217	821	165	50	175	53
	100	7	30	115	30	115	87	26	97	30
			95	360	95	360	140	43	150	46
			125	475	125	475	155	47	165	50
			150	550	150	550	160	49	170	52
			200	750	200	750	170	52	180	55
			250	950	250	950	175	53	185	56
125	8.5	30	115	34	129	97	30	107	33	
		95	360	106	401	145	44	155	47	
		125	475	140	530	100	49	170	52	
		150	550	168	636	175	53	185	56	
		200	750	224	848	180	55	190	58	
		250	950	280	1060	195	59	205	62	

SaberJet™ Fog Flow				
Style	Nozzle Pressure		Flow	
	PSI	BAR	GPM	LPM
1520	50	3.5	67	254
	75	5	82	310
	100	7	95	360
1523	50	3.5	95	360
	75	5	118	447
	100	7	135	511

SaberJet Solid Bore Flow								
Tip Size	Nozzle Pressure		Solid Bore Flow		Solid Bore Reach*			
	PSI	BAR	GPM	LPM	Effective		Overall	
					FEET	METERS	FEET	METERS
1/2"	50	3.5	53	201	67	20	77	23
	75	5	64	243	87	27	97	30
5/8"	50	3.5	82	312	87	27	97	30
	75	5	101	384	107	33	117	36
3/4"	50	3.5	118	448	108	35	122	37
	75	5	145	551	117	36	135	41
7/8"	50	3.5	161	612	135	41	144	44
	75	5	197	749	156	47	165	50
15/16"	50	3.5	185	703	139	42	146	44
	75	5	226	859	161	49	170	52
1"	50	3.5	210	798	146	44	155	47
	75	5	257	977	165	50	170	52

SaberJet Combination Flows						
Style	Tip Size	Inlet Pressure		Flow		
		PSI	BAR	GPM	LPM	
1520	1/2"	50	3.5	110	416	
		75	5	140	530	
	5/8"	50	3.5	136	515	
		75	5	170	643	
1523	3/4"	50	3.5	199	753	
		75	5	247	935	
	7/8"	50	3.5	232	878	
		75	5	289	1094	
		50	3.5	250	946	
	15/16"	75	5	313	1185	
		1"	50	3.5	270	1022
			75	5	334	1264

\*Note: Reach figures are measured with nozzle at 32" above horizontal. Overall reach is considered where farthest droplets of water fall, in still conditions. Effective reach is considered the farthest portion of the water droplet foot print where fire fighting can be accomplished, in still conditions. Actual results will vary depending on conditions.



Assault™ Nozzles Rated At 100 Psi												
Style	100 PSI Flow Setting	Actual Flow				Straight Stream Reach*						
		75 PSI 5 BAR	100 PSI 7 BAR	125 PSI 8.5 BAR		Effective			Overall			
						75 PSI 5 BAR	100 PSI 7 BAR	125 PSI 8.5 BAR	75 PSI 5 BAR	100 PSI 7 BAR	125 PSI 8.5 BAR	
4801, 4802 4804	13 50	11 42	13 49	15 57	gpm lpm	57 77	67 20	74 23	67 20	77 23	84 26	feet meters
	25 95	22 83	25 95	28 106	gpm lpm	70 21	77 23	87 27	80 24	87 27	97 30	feet meters
	40 150	35 132	40 150	45 170	gpm lpm	77 23	85 26	97 30	87 27	95 29	107 33	feet meters
4714, 4715 4717, 4720 4814, 4815 4817, 4820 4862, 4863 4866, 4867	95 360	82 310	95 360	106 401	gpm lpm	87 30	117 36	127 39	107 33	127 39	137 42	feet meters
	125 475	108 409	125 475	140 530	gpm lpm	117 36	127 39	130 40	127 39	137 42	140 44	feet meters
	150 550	130 492	150 550	168 636	gpm lpm	137 42	142 43	155 47	147 45	152 46	165 50	feet meters
	175 660	152 575	175 660	196 742	gpm lpm	145 44	153 47	165 50	155 47	163 50	175 53	feet meters
	200 750	173 655	200 750	224 848	gpm lpm	130 40	145 44	164 50	140 44	155 47	174 53	feet meters
4822, 4823 4824, 4825 4826, 4827 4837	200 750	173 655	200 750	224 848	gpm lpm	160 49	190 58	195 59	170 52	200 61	205 62	feet meters
	250 950	217 821	250 950	280 1060	gpm lpm	185 56	195 59	215 65	195 59	205 62	225 68	feet meters
	300 1140	260 984	300 1140	335 1268	gpm lpm	185 56	215 65	225 68	195 59	225 68	235 72	feet meters
	350 1325	303 1147	350 1325	391 1480	gpm lpm	185 56	210 64	225 68	195 59	220 67	235 72	feet meters

Assault Nozzles Rated At 75 Psi												
Style	75 PSI Flow Setting	Actual Flow				Straight Stream Reach*						
		75 PSI 5 BAR	100 PSI 7 BAR	125 PSI 8.5 BAR		Effective			Overall			
						75 PSI 5 BAR	100 PSI 7 BAR	125 PSI 8.5 BAR	75 PSI 5 BAR	100 PSI 7 BAR	125 PSI 8.5 BAR	
4714, 4715 4717, 4720 4814, 4815 4817, 4820 4862, 4863, 4866, 4867	95 360	95 360	110 416	123 466	gpm lpm	107 33	125 38	127 39	117 39	135 41	137 42	feet meters
	125 475	125 475	144 545	161 609	gpm lpm	127 39	130 40	135 41	137 42	140 43	145 44	feet meters
	150 550	150 550	173 655	194 734	gpm lpm	127 39	140 43	145 44	137 42	150 46	155 47	feet meters
	175 660	175 660	202 765	226 855	gpm lpm	127 39	146 45	150 46	137 42	156 48	160 49	feet meters
	200 750	200 750	231 874	258 977	gpm lpm	162 48	170 52	172 52	186 57	194 59	196 58	feet meters
4822, 4823 4824, 4825 4826, 4827 4837	250 950	250 950	289 1094	323 1223	gpm lpm	165 50	176 54	178 54	188 57	196 60	198 60	feet meters
	300 1140	300 1140	346 1310	387 1465	gpm lpm	171 52	179 55	181 55	190 58	198 60	200 61	feet meters

\*Note: Reach figures are measured with nozzle at 32° above horizontal. Overall reach is considered where farthest droplets of water fall, in still conditions. Effective reach is considered the farthest portion of the water droplet foot print where fire fighting can be accomplished, in still conditions. Actual results will vary depending on conditions.

Solid Bore Tips*									
Style	Size	Nozzle Pressure		Actual Flow		Straight Stream Reach*			
		PSI	BAR	GPM	LPM	Effective		Overall	
						FEET	METERS	FEET	METERS
1430	1/2"	50	3.5	53	201	97	30	110	34
		80	5.5	66	250	121	37	140	43
	7/8"	50	3.5	159	602	130	40	150	46
		80	5.5	201	761	156	48	175	53
439	1/2"	50	3.5	53	201	94	29	102	31
		80	5.5	66	250	106	32	123	37
	1 1/16"	50	3.5	182	689	142	43	152	46
		80	5.5	230	871	175	53	185	56

Excel 1000™ Master Stream Nozzles										
Style	Nozzle Pressure		Flow Setting		Actual Flow		Straight Stream Reach*			
	PSI	BAR	GPM	LPM	GPM	LPM	Effective		Overall	
							FEET	METERS	FEET	METERS
1747 3747 5147	75	5	300	1140	260	984	150	46	160	49
			500	1900	425	1646	190	58	200	61
			800	3030	693	2623	215	66	225	69
			1000	3800	866	3278	240	73	250	76
	100	7	300	1140	300	1140	170	52	180	55
			500	1900	500	1900	225	69	235	72
			800	3030	800	3030	242	74	252	77
			1000	3800	1000	3800	280	85	290	88
	125	8.5	300	1140	335	1268	190	58	200	61
			500	1900	560	2120	239	73	249	76
			800	3030	894	3384	270	82	280	85
			1000	3800	1118	4232	290	88	300	91
5148	75	5	800	3030	808	3070	220	67	240	73
			100	7	800	3030	945	3591	240	73
	125	8.5	800	3030	1045	3971	260	79	280	85
			75	5	1000	3800	1015	3857	240	73
	100	7	1000	3800	1170	4446	260	79	280	85
	125	8.5	1000	3800	-	-	-	-	-	-

SaberMaster™ Solid Bore Flow									
Style	Tip	Nozzle Pressure		Solid Bore Flow		Straight Stream Reach*			
		PSI	BAR	GPM	LPM	Effective		Overall	
						FEET	METERS	FEET	METERS
1545	1 3/8	50	3.5	380	1438	160	49	107	52
	1 3/8	75	5	480	1817	185	56	210	64
	1 3/8	100	7	557	2108	230	70	250	76
	1 3/8	125	8.5	615	2328	240	73	260	79
1578	2"	80	5.5	1065	4030	275	84	285	87
1578	1 1/2"	80	5.5	600	2270	210	64	220	67
1578	1 3/8"	80	5.5	500	1890	205	62.5	215	65.5

Akromatic® Master Stream Nozzles								
Style	Nozzle Pressure		Actual Flow		Straight Stream Reach*			
	PSI	BAR	GPM	LPM	Effective		Overall	
					FEET	METERS	FEET	METERS
5051 5055 5056	100	7	300	1140	170	52	180	55
			500	1900	200	61	210	64
			700	2660	220	67	230	70
			1000	3800	230	70	240	73
			250	950	140	43	150	46
5068 5075	80	5.5	500	1900	185	56	200	61
			750	2900	230	70	240	73
			1000	3800	260	79	270	82
			1250	4800	285	87	295	90
			250	950	140	42	160	48
5160 5177	80	5.5	500	1900	210	64	220	67
			750	2900	245	75	260	79
			1000	3800	270	82	285	86
			1250	4800	295	90	305	93
			500	1900	145	44	155	47
5170 5071 5178	80	5.5	1000	3800	210	64	220	67
			1250	4800	225	69	235	72
			1500	5700	255	78	265	81
			2000	7600	300	91	310	95
			300	1140	130	40	140	43
5150	75	5	500	1900	180	55	190	58
			800	3030	225	69	235	72
			1000	3800	255	78	270	82

\* Pressure varies slightly as flow rate changes on automatic nozzles.

FireFox™ Electric Nozzle Flow/reach Data										
Style	Nozzle Pressure		Flow Setting		Actual Flow		Straight Stream Reach*			
	PSI	BAR	GPM	LPM	GPM	LPM	Effective		Overall	
							FEET	METERS	FEET	METERS
3293	100	7	30	115	30	115	74	23	84	26
			60	230	60	230	90	27	104	32
			95	360	95	360	120	37	130	40
			125	475	125	475	125	38	135	41
			175	660	175	660	135	41	145	44
			250	950	250	950	155	47	170	52
			350	1325	350	1325	170	52	190	58
			400	1525	400	1525	190	58	200	61
			450	1700	450	1700	200	61	220	67
			500	1900	500	1900	210	64	225	69

Turbomaster™ Master Stream Nozzle										
Style	Nozzle Pressure		Flow Setting		Actual Flow		Straight Stream Reach*			
	PSI	BAR	GPM	LPM	GPM	LPM	Effective		Overall	
							FEET	METERS	FEET	METERS
1755	75	5	500	1900	433	1646	195	59	205	62
			750	2900	650	2460	215	66	220	67
			1000	3800	866	3278	230	70	240	73
			1250	4800	1083	4099	250	76	260	79
	100	7	500	1900	500	1900	220	67	230	70
			750	2900	750	2900	250	76	260	79
			1000	3800	1000	3800	265	81	275	84
			1250	4800	1250	4800	280	85	290	88
	125	8.5	500	1900	560	2120	245	75	255	78
			750	2900	839	3176	270	82	280	85
			1000	3800	1118	4232	290	88	300	91
			1250	4800	1398	5291	300	91	310	94

TurboMaster Master Stream										
Style	Nozzle Pressure		Flow Setting		Actual Flow		Straight Stream Reach*			
	PSI	BAR	GPM	LPM	GPM	LPM	Effective		Overall	
							FEET	METERS	FEET	METERS
1745	75	5	250	950	234	889	152	46	162	49
			400	1520	370	1406	190	58	200	61
			550	2100	508	1930	210	64	220	67
			750	2900	672	2554	240	73	250	76
	100	7	250	950	271	1030	170	52	180	55
			400	1520	430	1634	210	64	220	67
			550	2100	588	2234	250	76	260	79
			750	2900	775	2945	260	79	270	82
	125	8.5	250	950	302	1148	195	59	205	62
			400	1520	478	1816	250	76	260	79
			550	2100	650	2470	270	82	280	85
			750	2900	866	3291	273	83	283	86

\* Note: Reach figures are measured with nozzle at 32" above horizontal. Overall reach is considered where farthest droplets of water fall, in still conditions. Effective reach is considered the farthest portion of the water droplet foot print where fire fighting can be accomplished, in still conditions. Actual results will vary depending on conditions.



AquaStream™ & Mercury Master Stream Nozzles										
Style	Nozzle Pressure		Flow Setting		Actual Flow		Straight Stream Reach*			
	PSI	BAR	GPM	LPM	GPM	LPM	Effective		Overall	
							FEET	METERS	FEET	METERS
4450 4452	75	5	300	1140	260	984	155	47	165	50
			500	1900	435	1646	180	55	190	58
			700	2660	605	2290	180	55	190	58
*4445 *4447	100	7	300	1140	300	1140	175	53	185	56
			500	1900	500	1900	210	64	220	67
			700	2660	700	2660	205	62	215	66
*500 gpm MAX	125	8.5	300	1140	335	1268	200	61	220	64
			500	1900	560	2120	230	70	240	73
			700	2660	785	2971	210	64	222	68

Rampage™ Master Stream Nozzles										
Style	Nozzle Pressure		Flow Setting		Actual Flow		Straight Stream Reach*			
	PSI	BAR	GPM	LPM	GPM	LPM	Effective		Overall	
							FEET	METERS	FEET	METERS
4460 4461	75	5	500	1900	433	1646	195	59	205	63
			750	2900	650	2460	230	70	240	73
			1000	3800	866	3278	240	73	250	76
4460 4461	100	7	500	1900	500	1900	210	64	220	67
			750	2900	750	2900	265	81	270	82
			1000	3800	1000	3800	275	84	285	87
4460 4461	125	8.5	500	1900	560	2120	230	70	240	73
			750	2900	839	3176	275	84	285	87
			1000	3800	1118	4232	290	88	300	91

AeroMaster12 Master Stream Nozzle								
Style	Monitor Inlet Pressure		Flow Setting		Straight Stream Reach*			
	PSI	BAR	GPM	LPM	Effective		Overall	
					FEET	METERS	FEET	METERS
3700 3701	145	10	2640	10000	378	115	394	120
			3170	12000	394	120	410	125
With 730	145	10	2640	10000	312	95	328	100
			3170	12000	328	100	394	105

Black Widow™ Master Stream Nozzles										
Style	Nozzle Pressure		Flow Setting		Actual Flow		Straight Stream Reach*			
	PSI	BAR	GPM	LPM	GPM	LPM	Effective		Overall	
							FEET	METERS	FEET	METERS
2151	100	7	300	1140	300	1140	180	55	-	-
2152			500	1900	500	1900	210	64	-	-
2155			700	2660	700	2660	230	70	-	-
2156			1000	3800	1000	3800	240	73	-	-
2158			1000	3800	1000	3800	240	73	-	-

\* Note: Reach figures are measured with nozzle at 32" above horizontal. Overall reach is considered where farthest droplets of water fall, in still conditions. Effective reach is considered the farthest portion of the water droplet foot print where fire fighting can be accomplished, in still conditions. Actual results will vary depending on conditions.

Akrofoam Master Stream Nozzle								
Style	Nozzle Pressure		Flow Setting		Straight Stream Reach*			
	PSI	BAR	GPM	LPM	Effective		Overall	
					FEET	METERS	FEET	METERS
4470 4471 4475 4480	100	7	350	1300	150	47	170	52
			500	1900	190	58	210	64
			750	2800	215	66	240	73
			1000	3800	245	74	270	82
4478 4479	100	7	750	2800	195	60	205	62
			1000	3800	230	70	240	73
			1500	5700	290	88	300	91
			2000	7600	320	98	325	99

Renegade™ Monitor Nozzles							
Style	Type	GPM	LPM	Straight Stream Reach*			
				Effective		Overall	
				FEET	METERS	FEET	METERS
5088	Automatic	1000	3800	185	56	195	60
		2500	9500	275	84	285	87
		5000	19000				
2189	Adjustable	1000	3800				
		2000	7600				
		3000	11500	280	85	300	92
2188	Fixed	1000	3800				
		2000	7600				
		3000	11500				
		4000	15000	355	108		
5000	19000						

Akrochem			
Straight Stream at 3% AFFF*			
Style	Flow Rate gpm (lpm)	Effective Reach ft (m)	Overall Reach ft (m)
4039, 4040	250 (950)	155 (47)	165 (50)
	500 (1900)	168 (51)	178 (54)
	750 (2900)	205 (62)	215 (65)
	1000 (3800)	222 (68)	232 (71)
	1250 (4800)	232 (71)	242 (74)

Style	Straight Stream Water only*			Straight Stream 3% AFFF*		Straight Stream 3% AR AFFF*	
	Flow Rate gpm (lpm)	Effective Reach ft (m)	Overall Reach ft (m)	Effective Reach ft (m)	Overall Reach ft (m)	Effective Reach ft (m)	Overall Reach ft (m)
4478	750 (2900)	200 (61)	210 (64)	170 (52)	180 (55)	185 (56)	195 (59)
	1000 (3800)	235 (72)	245 (75)	210 (64)	220 (67)	210 (64)	220 (67)
	1500 (5700)	290 (88)	300 (91)	250 (76)	260 (79)	260 (79)	270 (82)
	2000 (7600)	315 (96)	320 (98)	260 (79)	270 (82)	280 (85)	290 (88)

## Typical Eductor To Crosslay With Off-Truck Foam Access - One Tank

- A: Style 1477 Remote with FLUSH tag
- B: Style 1477 Remote with EDUCTOR tag
- C: Style 1477 Remote with WATER tag
- D: Style 1477 Remote with FOAM tag
- E: Styles 3096 or 3126 Foam Metering Dial
- F: Styles 3096 or 3126 By-Pass Eductor
- G: Style 8820 - P1-S x P30-SCV (Check Valve) x R-1 Swing-Out™ Valve
- H: Style 8810 - P1-S x P1-S x R-1 - 1" Foam Valve

- I: 1" Check Valve
- J: Style 8810 - P1-S x P1-S x R-1 - 1" Flush Valve
- K: Style 635 - 2" NPT x 1 1/2" Crosslay Elbow
- L: Style 57 - 3/4" Off-Truck Foam Valve - In Style 3128 Kit
- M: 25mm Storz x 3/4" NPT Panel Fitting - In Style 3128 Kit
- N: Dust Plug with chain - In Style 3128 Kit
- O: 25mm Storz x 5 ft. Pick-up hose assembly - In Style 3128 Kit
- P: 1" Check Valve - In Style 3128 Kit

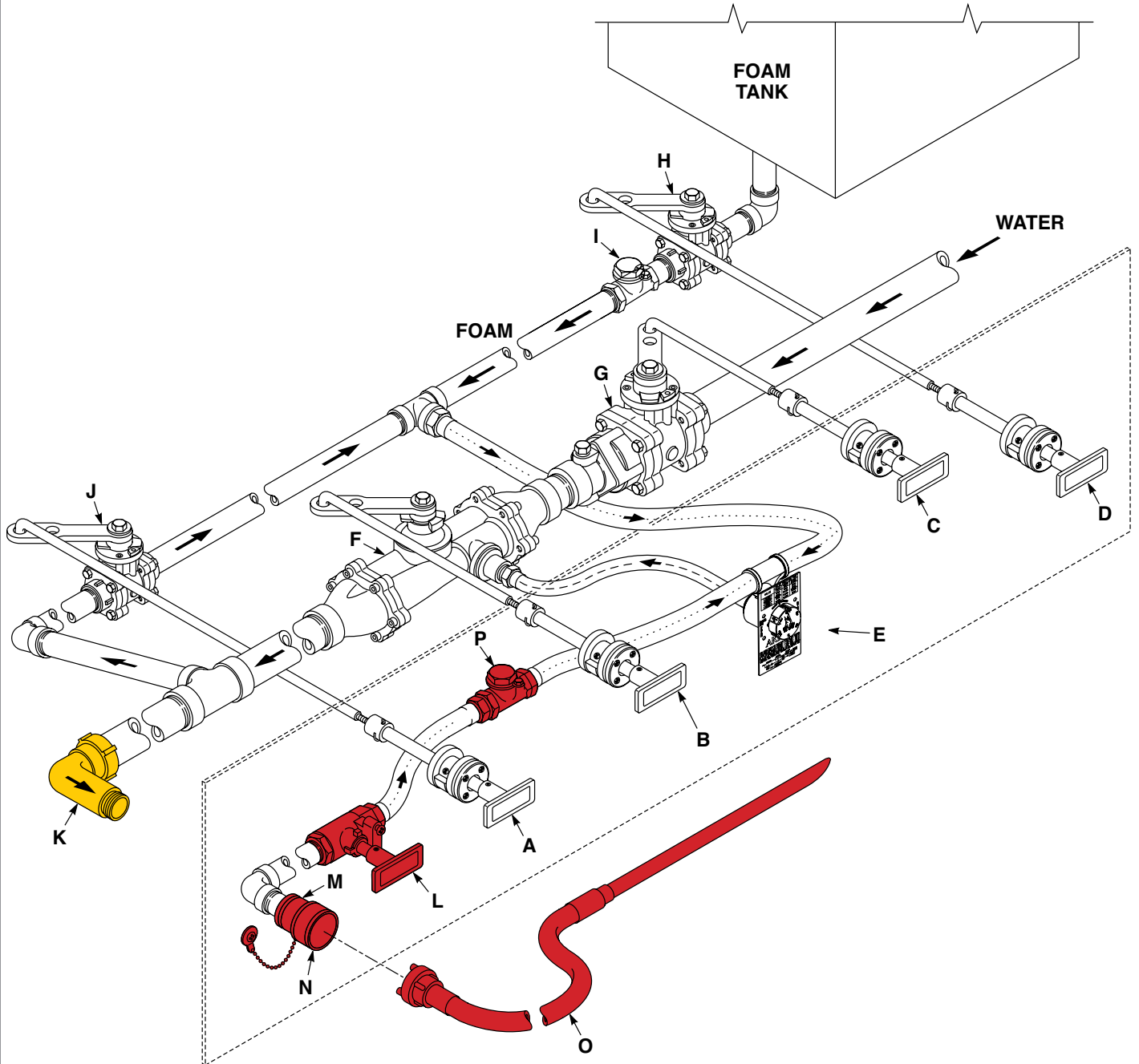

	Cross Elbow
	O Truck System STYLE 3128
	Meter to Eductor - 1/2" I.D. Minimum
	Foam to Meter - 3/4" I.D. Minimum

## Typical Eductor To Crosslay With Off-Truck Foam Access - Two Tank

- |  |  |
|--|--|
| <p>A: Style 1477 Remote with FLUSH tag<br/>                 B: Style 1477 Remote with EDUCTOR tag<br/>                 C: Style 1477 Remote with WATER tag<br/>                 D: (2) Style 1477 Remote with FOAM tag<br/>                 E: Styles 3096 or 3126 Foam Metering Dial<br/>                 F: Styles 3096 or 3126 By-Pass Eductor<br/>                 G: Style 8820 - P1-S x P30-SCV (Check Valve) x R-1 Swing-Out™ Valve<br/>                 H: Style 8810 - P1-S x P1-S x R-1 - 1" Foam Valve<br/>                 I: 1" Check Valve</p> | <p>J: Style 8810 - P1-S x P1-S x R-1 - 1" Flush Valve<br/>                 K: Style 635 - 2" NPT x 1 1/2" Crosslay Elbow<br/>                 L: Style 57 - 3/4" Off-Truck Foam Valve - In Style 3128 Kit<br/>                 M: 25mm Storz x 3/4" NPT Panel Fitting - In Style 3128 Kit<br/>                 N: Dust Plug with chain - In Style 3128 Kit<br/>                 O: 25mm Storz x 5 ft. Pick-up hose assembly - In Style 3128 Kit<br/>                 P: 1" Check Valve - In Style 3128 Kit</p> |
|--|--|

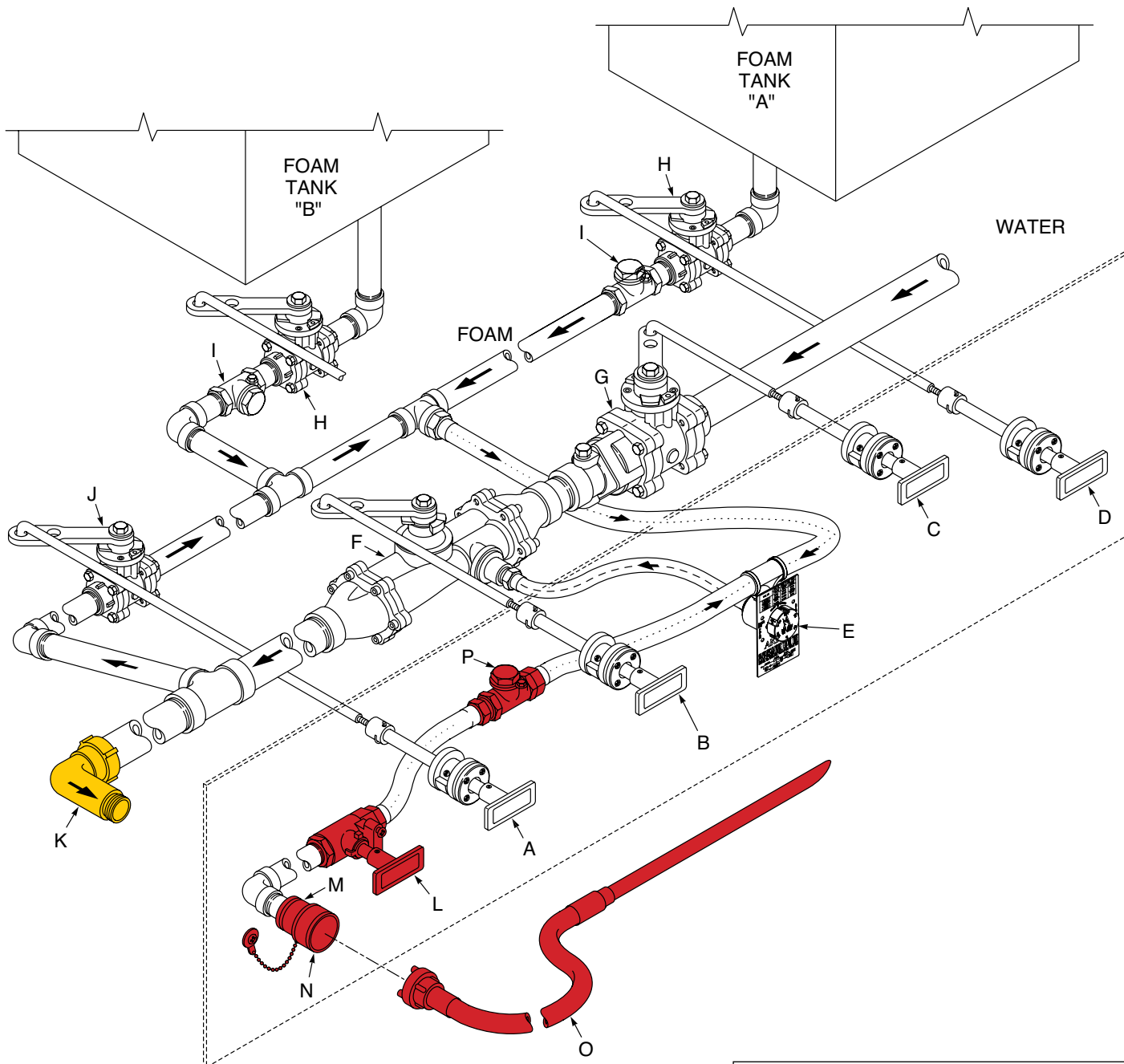

	Cross Elbow
	O Truck System STYLE 3128
	Meter to Eductor - 1/2" I.D. Minimum
	Foam to Meter - 3/4" I.D. Minimum



The following is a listing of the most commonly used threads. However, Akron Brass has the ability to cut many other threads required by the fire service.

Akron identifies all unique threads with a 3-letter Thread Code. Simply use the code when ordering Akron product to obtain a proper fit. If this is not possible, either indicate the city and state of use or supply a copy of thread specifications.

Distinct Threads																								
Size	National Standard Nh (Nst)*			Straight Iron Pipe Npsh (Ipt)			New York Corporation Nyc			Pacifica Coast Pct			New York Fire Dept. Fdny			Chicago Fire Dept			Chicago Hose			British Standard Pipe Thread Bsp†		
	Odm	Tpi	Thread Code	Odm	Tpi	Thread Code	Odm	Tpi	Thread Code	Odm	Tpi	Thread Code	Odm	Tpi	Thread Code	Odm	Tpi	Thread Code	Odm	Tpi	Thread Code	Odm	Tpi	Thread Code
3/4"	1.375	8	AAP	1.0353*	14	AAA	-	-	-	1.0625	11	AAD	-	-	-	-	-	-	1.081	11 1/2	AAF	1.041	14	AAB
1"	1.375	8	AAP	1.295*	11 1/2	AJ	-	-	-	1.3125	11 1/2	AAL	1.66	8	AAS	-	-	-	1.2951	11 1/2	AAI	1.309	11	AAK
1 1/4"	1.6718	9	ACF	1.6399*	11 1/2	ACB	-	-	-	1.86	11	ACH	-	-	-	-	-	-	1.705	11 1/2	ACG	1.65	11	ACD
1 1/2"	1.99	9	ABM	1.8788*	11 1/2	AAY	2.093	11	ABQ	2.1	11	ABT	2.1	8	ABU	1.933	11 1/2	ABE	1.952	11 1/2	ABH	1.882	11	AAZ
2"	2.5156	8	ACM	2.3528*	11 1/2	ACK	2.561	11	ACP	2.55	10	ACQ	-	-	-	-	-	-	2.522	8	ACO	2.347	11	ACJ
2 1/2"	3.0686	7 1/2	AGL	2.841*	8	ACV	3	8	AEF	3.046	7 1/2	AFJ	3.03	8	AFB	2.99	7 1/2	ADZ	3.046	7	AFD	2.96	11	ADL
3"	3.6239	6	ALC	3.47	8	AKY	-	-	-	-	-	-	3.63	8	ALE	-	-	-	-	-	-	3.46	11	AKX
3 1/2"	4.2439	6	ALS	3.97	8	ALJ	-	-	-	-	-	-	4.07	8	ALN	4.052	8	ALL	-	-	-	-	-	-
4"	5.0109	4	ANT	4.47	8	ALV	-	-	-	-	-	-	4.61	8	AMA	5.011	4	ANT	-	-	-	4.45	11	ASB
4 1/2"	5.7609	4	APV	4.97	8	AOP	-	-	-	-	-	-	5.8	4	APX	5.761	4	APV	-	-	-	4.95	11	BAN
5"	6.26	4	ARD	5.535	8	APZ	-	-	-	-	-	-	-	-	-	6.26	4	ARD	-	-	-	5.45	11	AUD
6"	7.025	4	ARQ	6.592	8	ARF	-	-	-	-	-	-	-	-	-	7.025	4	AUJ	-	-	-	6.45	11	AUI

1 1/2" Underwriters Playpipe (PPS) - 2.1875 ODM, 12 TPI (ABX)  
 1/2" Garden Hose Thread (GHT) - 1.0625 ODM, 11 1/2 TPI (AAE)

\* National Form Thread  
 † Whitworth Form Thread

ODM = Outside Diameter of Male  
 TPI = Threads Per Inch

Abbreviation for tapered iron pipe threads in NPT (National Pipe Tapered) or TIPT.  
 Abbreviation for straight iron pipe threaded is NPSH, IPT or SIPT.

**NOTE: NPT Thread Not Available in Female Swivels**

Flanges			
American Standards Association (ASA) Flange	2 1/2"	3"	4"
Outside Diameter	7"	7 1/2"	9"
Bolt Circle Diameter	5 1/2"	6"	7 1/2"
Bolt Size	5/8"	5/8"	5/8"
Number of Bolt Holes	4	4	8

**Hose, Coupling & Nozzle Inlet Sizes**  
 This chart is typically applicable to NH/NST fire hose thread

Hose Size	Coupling Size	Hand Line Nozzle Inlet Size
3/4"	1"	1"
1"	1"	1"
1 1/2"	1.5"	1.5"
1 3/4"	1.5"	1.5"
2"	1.5"	1.5"
2 1/2"	2.5"	2.5"
3"	2.5"	2.5"

Canadian Standard 2 1/2" Hose Threads				
Size	Description	Thread Codes	Odm	Tpi
2 1/2"	AMA - Alberta Mutual Aid	AEA	2.99	8*
2 1/2"	BCT - British Columbia	AEH	3	8*
2 1/2"	CSA - Canadian Standards Association - Ontario - All	All	3.125	5*
2 1/2"	QST - Province of Quebec Standard	AFD	3.031	7
2 1/2"	Western Canada Fire Underwriters Association	AKB	3.25	6
2 1/2"	Nova Scotia - Zone 1	AJN	3.23	5

\*National Form Thread

Suction Hose Threads (Reference Only)												
	4"			4 1/2"			5"			6"		
	Odm	Tpi	Thread Code	Odm	Tpi	Thread Code	Odm	Tpi	Thread Code	Odm	Tpi	Thread Code
American La France	5.085	4	AOC	5.7609**	4	APW	6.15	4	AQO	7.000**	4	ARP
Mack Truck	5.0109**	4	ANT	5.7609**	4	APV	-	-	-	6.9559	4	ARJ
Maxim	5.000**	4	ANR	5.750**	4	APW	6.250**	4	ARB	7.000**	4	ARP
Seagrave FWD	4.955	4	ANR	-	-	-	6.055	4	AQJ	7.055	4	ART
Ward La France	5.0109**	4	ANT	5.7609**	4	AUR	6.260**	4	ARD	7.025**	4	ARQ
Hale Products	5.010**	4	ANT	5.760**	4	APW	6.260**	4	ARD	7.025**	4	ARQ
Waterous Fire	5.0109**	4	ANT	5.7609**	4	APV	6.260**	4	ARD	7.261	4	ARW
										Also uses NH		
										7.025**	4	ARQ

\*\* Falls within the range of NH Thread

All dimensions shown are the Maximum ODM



Liquid Volume		
To Convert	Into	Multiply by
Ounces (oz)	Milliliters (ml)	29.57
Pints (pt)	Liters (l)	0.4732
Quarts (qt)	Liters (l)	0.9464
Gallons (gal)	Liters (l)	3.785
Milliliters (ml)	Ounces (oz)	0.0338
Liters (l)	Pints (pt)	2.113
Liters (l)	Quarts (qt)	1.057
Liters (l)	Gallons (gal)	0.2642
Pressure		
To Convert	Into	Multiply by
Pounds per square inch (psi)	Kilopascals (kPa)	6.895
Pounds per square inch (psi)	bar	0.06895
Kilopascals (kPa)	Pounds per square inch (psi)	0.145
Kilopascals (kPa)	bar	0.01
bar	Pounds per square inch (psi)	14.503
bar	Kilopascals (kPa)	100
Length		
To Convert	Into	Multiply by
Inches (in)	Millimeters (mm)	25.4
Inches (in)	Centimeters (cm)	2.54
Feet (ft)	Centimeters (cm)	30.48
Feet (ft)	Meters (m)	0.3048
Yards (yd)	Meters (m)	0.914
Miles (mi)	Kilometers (km)	1.609
Millimeters (mm)	Inches (in)	0.039
Centimeters (cm)	Inches (in)	0.394
Meters (m)	Feet (ft)	3.282
Kilometers (km)	Miles (mi)	0.6214
Area		
To Convert	Into	Multiply by
Square Inches (in <sup>2</sup> )	Square Centimeters (cm <sup>2</sup> )	6.452
Square Feet (ft <sup>2</sup> )	Square Meters (m <sup>2</sup> )	0.093
Square Yards (yds <sup>2</sup> )	Square Meters (m <sup>2</sup> )	0.836
Square Miles (mi <sup>2</sup> )	Square Kilometers (km <sup>2</sup> )	2.59
Square Centimeters (cm <sup>2</sup> )	Square Inches (in <sup>2</sup> )	0.155
Square Meters (m <sup>2</sup> )	Square Yards (yds <sup>2</sup> )	1.196
Square Kilometers (km <sup>2</sup> )	Square Miles (mi <sup>2</sup> )	0.386
Hose Sizes		
1" Hose	=	25.4 mm
1 1/2" Hose	=	38.1 mm
1 3/4" Hose	=	44.5 mm
2" Hose	=	50.8 mm
2 1/2" Hose	=	63.5 mm
3" Hose	=	76.2 mm
3 1/2" Hose	=	88.9 mm
Tip Sizes		
3/4" Tip	=	19 mm
7/8" Tip	=	22 mm
1" Tip	=	25 mm
1 1/8" Tip	=	29 mm
1 1/4" Tip	=	32 mm
1 3/8" Tip	=	35 mm

Solid Volume		
To Convert	Into	Multiply by
Ounces (oz)	Grams (g)	28.3495
Pounds (lb)	Kilograms (kg)	0.4536
Grams (g)	Ounces (oz)	0.035
Kilograms (kg)	Pounds (lb)	2.205
Pressures		
50 psi	=	345 kPa = 3.45 bar
60 psi	=	414 kPa = 4.14 bar
70 psi	=	488 kPa = 4.88 bar
75 psi	=	517 kPa = 5.17 bar
80 psi	=	552 kPa = 5.52 bar
90 psi	=	621 kPa = 6.21 bar
100 psi	=	690 kPa = 6.90 bar
150 psi	=	1034 kPa = 10.34 bar
200 psi	=	1379 kPa = 13.79 bar
250 psi	=	1723 kPa = 17.23 bar
300 psi	=	2069 kPa = 20.69 bar
350 psi	=	2413 kPa = 24.13 bar
580 psi	=	3999 kPa = 39.99 bar
700 psi	=	4827 kPa = 48.27 bar
Flow		
Flow Rate	Exact LPM	Akron Standard
12 gpm	=	45.42 lpm = 45 lpm
13 gpm	=	49.20 lpm = 50 lpm
15 gpm	=	56.78 lpm = 60 lpm
20 gpm	=	75.70 lpm = 75 lpm
23 gpm	=	87.06 lpm = 90 lpm
25 gpm	=	94.62 lpm = 95 lpm
30 gpm	=	113.55 lpm = 115 lpm
40 gpm	=	151.40 lpm = 150 lpm
50 gpm	=	189.25 lpm = 190 lpm
60 gpm	=	227.10 lpm = 230 lpm
70 gpm	=	264.95 lpm = 265 lpm
75 gpm	=	283.88 lpm = 285 lpm
85 gpm	=	321.73 lpm = 320 lpm
95 gpm	=	359.58 lpm = 360 lpm
100 gpm	=	378.50 lpm = 380 lpm
120 gpm	=	454.20 lpm = 460 lpm
125 gpm	=	473.13 lpm = 475 lpm
150 gpm	=	567.75 lpm = 550 lpm
175 gpm	=	662.38 lpm = 660 lpm
200 gpm	=	757.00 lpm = 750 lpm
250 gpm	=	946.25 lpm = 950 lpm
300 gpm	=	1135.50 lpm = 1140 lpm
350 gpm	=	1324.75 lpm = 1325 lpm
375 gpm	=	1419.38 lpm = 1420 lpm
400 gpm	=	1514.00 lpm = 1525 lpm
450 gpm	=	1703.25 lpm = 1700 lpm
500 gpm	=	1892.50 lpm = 1900 lpm
550 gpm	=	2081.75 lpm = 2100 lpm
700 gpm	=	2649.50 lpm = 2660 lpm
750 gpm	=	2838.75 lpm = 2900 lpm
800 gpm	=	3028.00 lpm = 3030 lpm
1000 gpm	=	3785.00 lpm = 3800 lpm
1200 gpm	=	4542.00 lpm = 4500 lpm
1250 gpm	=	4731.25 lpm = 4800 lpm
1500 gpm	=	5677.50 lpm = 5700 lpm
2000 gpm	=	7570.00 lpm = 7600 lpm

## Solid Bore Nozzles Rated at 50 PSI

Nozzle Pressure* (PSI)	Gallons Per Minute (GPM)										Pounds Reaction Force † (RF)								
	Solid Bore Diameter (Inches)																		
	3/8"	1/2"	5/8"	3/4"	7/8"	15/16"	1"	1 1/8"	1 3/16"	1 1/4"	1 3/8"	1 1/2"	1 3/4"	2"	2 1/4"	2 1/2"	2 3/4"		
40	26	47	73	106	144	165	188	238	265	294	355	423	575	752	951	1174	1421	gpm	
	9	16	25	35	48	55	63	79	89	98	119	141	192	251	318	393	475	rf	
45	28	50	78	112	153	175	199	252	281	311	377	448	610	797	1009	1246	1507	gpm	
	10	18	28	40	54	62	71	89	100	110	134	159	216	283	358	442	534	rf	
50	30	53	82	118	161	185	210	266	296	328	397	473	643	840	1064	1313	1589	gpm	
	11	20	31	44	60	69	79	99	111	123	148	177	240	314	397	491	594	rf	
55	31	55	86	124	169	194	220	279	309	344	417	496	675	881	1115	1377	1666	gpm	
	12	22	34	49	66	76	86	109	122	135	163	194	264	345	437	540	653	rf	
60	32	58	90	129	176	202	230	291	325	360	435	518	705	921	1165	1438	1740	gpm	
	13	24	37	53	72	83	94	119	133	147	178	212	288	377	477	589	712	rf	
65	34	60	94	135	183	211	240	303	338	374	453	539	734	958	1213	1497	1811	gpm	
	14	26	40	57	78	90	102	129	144	159	193	230	313	408	517	638	772	rf	
70	35	62	97	140	190	218	249	315	351	388	470	559	761	994	1258	1554	1880	gpm	
	15	27	43	62	84	97	110	139	155	172	208	247	337	440	556	687	831	rf	
75	36	64	101	145	197	226	257	326	363	402	486	579	788	1029	1303	1608	1946	gpm	
	17	29	46	66	90	103	118	149	166	184	223	265	361	471	596	736	890	rf	
80	37	66	104	149	203	234	266	336	375	415	502	598	814	1063	1345	1661	2010	gpm	
	18	31	49	71	96	110	126	159	177	196	237	283	385	502	636	785	950	rf	
85	39	68	107	154	210	241	274	347	386	428	518	616	839	1096	1387	1712	2071	gpm	
	19	33	52	75	102	117	133	169	188	209	252	300	409	534	676	834	1009	rf	
90	40	70	110	159	216	248	282	357	397	440	533	634	863	1127	1427	1762	2132	gpm	
	20	35	55	79	108	124	141	179	199	221	267	318	433	565	715	883	1069	rf	
95	41	72	113	163	222	255	290	366	408	452	547	652	887	1158	1466	1810	2190	gpm	
	21	37	58	84	114	131	149	189	210	233	282	336	457	597	755	932	1128	rf	
100	42	74	116	167	227	261	297	376	419	464	562	668	910	1188	1504	1857	2247	gpm	
	22	39	61	88	120	138	157	199	221	245	297	353	481	628	795	981	1187	rf	
105	43	76	119	171	233	268	304	385	429	476	576	685	932	1218	1541	1903	2302	gpm	
	23	41	64	93	126	145	165	209	232	258	312	371	505	659	835	1030	1247	rf	
110	44	78	122	175	239	274	312	394	439	487	589	701	954	1246	1577	1948	2356	gpm	
	24	43	67	97	132	152	173	219	244	270	327	389	529	691	874	1079	1306	rf	
115	45	80	124	179	244	280	319	403	449	498	602	717	976	1274	1613	1991	2409	gpm	
	25	45	71	102	138	159	181	229	255	282	341	406	553	722	914	1128	1365	rf	
120	46	81	127	183	249	286	325	412	459	509	615	732	997	1302	1648	2034	2461	gpm	
	26	47	74	106	144	166	188	238	266	294	356	424	577	754	954	1178	1425	rf	
125	47	83	130	187	254	292	332	420	468	519	628	747	1017	1329	1682	2076	2512	gpm	
	28	49	77	110	150	172	196	248	277	307	371	442	601	785	994	1227	1484	rf	
130	48	85	132	191	259	298	339	429	478	529	640	762	1037	1355	1715	2117	2562	gpm	
	29	51	80	115	156	179	204	258	288	319	386	459	625	816	1033	1276	1544	rf	
135	49	86	135	194	264	303	345	437	487	539	653	777	1057	1381	1748	2157	2611	gpm	
	30	53	83	119	162	186	212	268	299	331	401	477	649	848	1073	1325	1603	rf	
140	49	88	137	198	269	309	352	445	496	549	665	791	1077	1406	1780	2197	2658	gpm	
	31	55	86	124	168	193	220	278	309	343	416	495	673	879	1113	1374	1662	rf	
145	50	89	140	201	274	314	358	453	504	559	676	805	1096	1431	1811	2236	2706	gpm	
	32	57	89	128	174	200	228	288	321	356	430	512	697	911	1152	1423	1722	rf	
150	51	91	142	205	279	320	364	461	513	569	688	819	1114	1455	1842	2274	2752	gpm	
	33	59	92	132	180	207	236	298	332	368	445	530	721	942	1192	1472	1781	rf	
175	55	98	154	221	301	345	393	497	554	614	743	884	1204	1572	1990	2456	2972	gpm	
	39	69	107	155	210	241	275	348	387	429	519	618	841	1099	1391	1717	2078	rf	
200	59	105	164	236	322	369	420	532	592	657	794	945	1287	1681	2127	2626	3177	gpm	
	44	79	123	177	240	276	314	397	443	491	594	707	962	1256	1590	1963	2375	rf	

References: National Fire Protection Association (NFPA) Fire Protection Handbook - 17th Edition International Fire Service Training Association (IFSTA) Fire Protection Publications - Fire Stream Practices - 7th Edition

\* Nozzle Pressure Measured with Pitot Gauge  
 † Reaction Force measured in pounds

Solid Bore Discharge Formula:  $GPM = 29.71D^2\sqrt{NP}$   
 Solid Bore Reaction Formula:  $NR = 1.57D^3NP$

D = Bore Diameter, NP = Nozzle Pressure (psi) Pitot Pressure



# Technical Data: Theoretical Discharge & Reaction



Fog Nozzles Rated at 100 PSI																	
GPM Setting	Gallons Per Minute (gpm)									Pounds Reaction Force† (rf)							
	Nozzle Pressure At Inlet (PSI)																
	50	55	60	65	70	75	80	85	90	95	100	105	110	115	120	125	
13	9	10	10	10	11	11	12	12	13	13	13	14	14	14	15		gpm
	3	4	4	4	5	5	5	6	6	6	7	7	7	8	8	8	rf
20	14	15	15	16	17	17	18	18	19	19	20	20	21	21	22	22	gpm
	5	6	6	7	7	8	8	9	9	10	10	11	11	12	12	13	rf
25	18	19	19	20	21	22	22	23	24	24	25	26	26	27	27	28	gpm
	6	7	7	8	9	10	10	11	11	12	13	13	14	15	16	16	rf
30	21	22	23	24	25	26	27	28	28	29	30	31	31	32	33	34	gpm
	8	8	9	10	11	11	12	13	14	14	15	16	17	17	18	19	rf
40	28	30	31	32	33	35	36	37	38	39	40	41	42	43	44	45	gpm
	10	11	12	13	14	15	16	17	18	19	20	21	22	23	24	25	rf
60	42	44	46	48	50	52	54	55	57	58	60	61	63	64	66	67	gpm
	15	17	18	20	21	23	24	26	27	29	30	32	33	35	36	38	rf
95	67	70	74	77	79	82	85	88	90	93	95	97	100	102	104	106	gpm
	24	26	29	31	34	36	38	41	43	46	48	50	53	55	58	60	rf
100	71	74	77	81	84	87	89	92	95	97	100	102	105	107	110	112	gpm
	25	28	30	33	35	38	40	43	45	48	51	53	56	58	61	63	rf
125	88	93	97	101	105	108	112	115	119	122	125	128	131	134	137	140	gpm
	32	35	38	41	44	47	51	54	57	60	63	66	69	73	76	79	rf
150	106	111	116	121	125	130	134	138	142	146	150	154	157	161	164	168	gpm
	38	42	45	49	53	57	61	64	68	72	76	80	83	87	91	95	rf
200	141	148	155	161	167	173	179	184	190	195	200	205	210	214	219	224	gpm
	51	56	61	66	71	76	81	86	91	96	101	106	111	116	121	126	rf
250	177	185	194	202	209	217	224	230	237	244	250	256	262	268	274	280	gpm
	63	69	76	82	88	95	101	107	114	120	126	133	139	145	152	158	rf
300	212	222	232	242	251	260	268	277	285	292	300	307	315	322	329	335	gpm
	76	83	91	98	106	114	121	129	136	144	152	159	167	174	182	189	rf
375	265	278	290	302	314	325	335	346	356	366	375	384	393	402	411	419	gpm
	95	104	114	123	133	142	152	161	170	180	189	199	208	218	227	237	rf
500	354	371	387	403	418	433	447	461	474	487	500	512	524	536	548	559	gpm
	26	139	152	164	177	189	202	215	227	240	253	265	278	290	303	316	rf
700	495	519	542	564	586	606	626	645	664	682	700	717	734	751	767	783	gpm
	177	194	212	230	247	265	283	300	318	336	354	371	389	407	424	442	rf
750	530	556	581	605	627	650	671	691	712	731	750	769	787	804	822	839	gpm
	189	208	227	246	265	284	303	322	341	360	379	398	417	436	455	473	rf
1000	707	742	775	806	837	866	894	922	949	975	1000	1025	1049	1072	1095	1118	gpm
	253	278	303	328	354	379	404	429	455	480	505	530	556	581	606	631	rf
1250	884	927	968	1008	1046	1083	1118	1152	1186	1218	1250	1281	1311	1340	1369	1398	gpm
	316	347	379	410	442	473	505	537	568	600	631	663	694	726	758	789	rf
1500	1061	1112	1162	1209	1255	1299	1342	1383	1423	1462	1500	1537	1573	1609	1643	1677	gpm
	379	417	455	492	530	568	606	644	682	720	758	795	833	871	909	947	rf
1750	1237	1298	1356	1411	1464	1516	1565	1613	1660	1706	1750	1793	1835	1877	1917	1957	gpm
	442	486	530	574	619	663	707	751	795	840	884	928	972	1016	1061	1105	rf
2000	1414	1483	1549	1612	1673	1732	1789	1844	1897	1949	2000	2049	2098	2145	2191	2236	gpm
	505	556	606	657	707	758	808	859	909	960	1010	1061	1111	1162	1212	1263	rf
3000	2121	2225	2324	2419	2510	2598	2683	2766	2846	2924	3000	3074	3146	3217	3286	3354	gpm
	758	833	909	985	1061	1136	1212	1288	1364	1439	1515	1591	1667	1742	1818	1894	rf
4000	2828	2966	3098	3225	3347	3464	3578	3688	3795	3899	4000	4099	4195	4290	4382	4472	gpm
	1010	1111	1212	1313	1414	1515	1616	1717	1818	1919	2020	2121	2222	2323	2424	2525	rf
5000	3536	3708	3873	4031	4183	4330	4472	4610	4743	4873	5000	5123	5244	5362	5477	5590	gpm
	1263	1389	1515	1641	1768	1894	2020	2146	2273	2399	2525	2651	2778	2904	3030	3156	rf

Fog Nozzle Discharge Formula:  $GPM = \frac{\text{Rated Flow} \times \sqrt{NP}}{\sqrt{\text{Rated NP}}}$

Fog Nozzle Reaction Formula:  $NR = 0.0505Q\sqrt{NP}$

NP = Nozzle Pressure (psi), Q = Flow (gpm)

References: National Fire Protection Association (NFPA) Fire Protection Handbook - 17th Edition  
International Fire Service Training Association (IFSTA) Fire Protection Publications - Fire Stream Practices - 7th Edition

† Reaction Force measured in pounds

## Akron Brass Handline Nozzle Order Checklist

There are many options for handline nozzles from Akron Brass. When ordering nozzles, this checklist is designed to help you choose exactly what you need. Please reference [akronbrass.com](http://akronbrass.com) or the Akron Brass catalog for the complete set of options\*.

### Standard Options (Must be specified on your PO\*)

- Akron Brass Brand Name, Style Number and/or 8-digit Part Number
- Quantity
- Flow Rate for Fog Tips or Nozzle (GPM or LPM) ①
- Pressure for Fog Tips or Nozzle (psi, bar, kPa) ①
- Discharge (orifice) Tip Size if Smooth Bore Nozzle or Tip ②
- Inlet ③
  - o Size (1.5", 2.5", 52 mm, etc.)
  - o Type (threaded swivel, BIM, JIM, Storz, etc.)
  - o Thread specification (NH, BSP, ABM, etc.)
- Pistol Grip ④
  - o Yes or No
  - o Color – Black is standard
- Handle ⑤
  - o Color – Black is standard
- Bumper ⑥
  - o Color (if available) – Black is standard

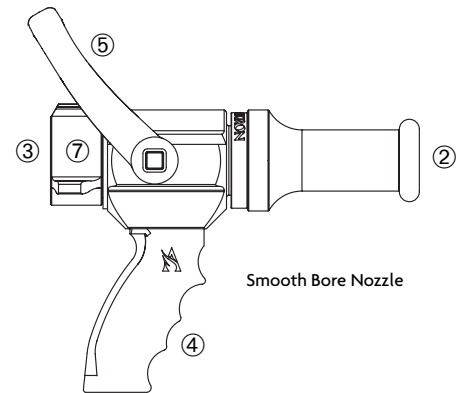
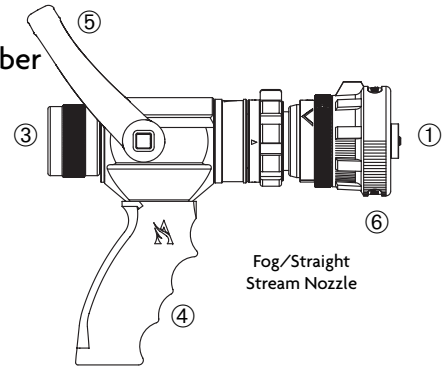

### Special Options and Considerations

- Custom Etching ⑦
- Certifications including NFPA, CE, FM, MED, SOLAS, U.S. Coast Guard, U.S. Navy
  - If ordering In-line or bypass eductors with nozzles, eductor flow must match the flow of the nozzles
- Verify whether non-twist shutoff or twist shutoff tip is required for break-apart nozzles
- Make sure the metals match between shutoffs and tips – example: Pyrolite Shutoff with Pyrolite Tips, Chrome Shutoff with Chrome Tips

### Nozzle Accessories\*

- Stream shaper
- Quick-Attack or Mid-X Medium Expansion Foam Tube

\*Options listed may not be available with all nozzles. Reference [akronbrass.com](http://akronbrass.com) or the Akron Brass catalog for a complete set of options.

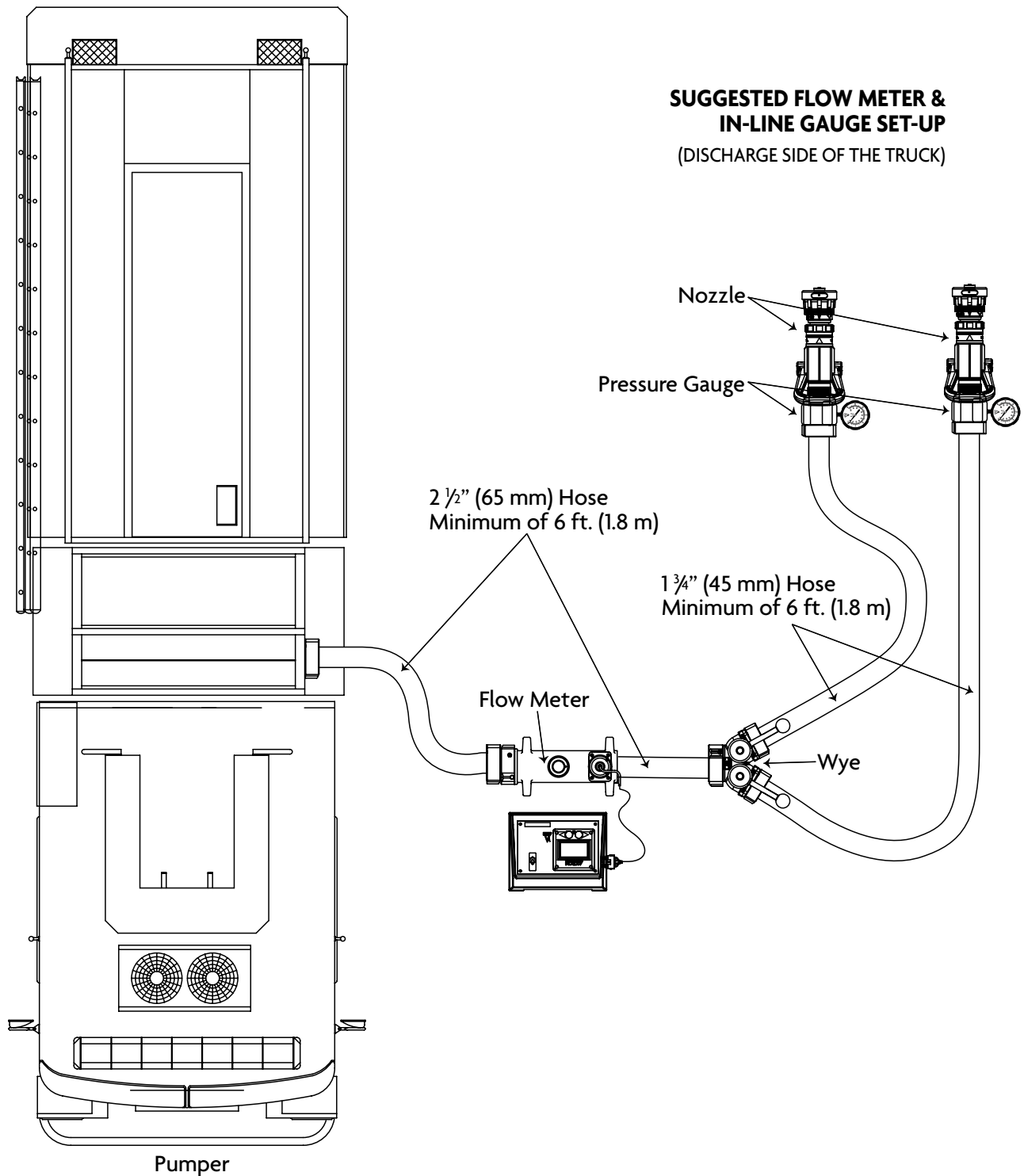

### Special Thread Measurement Description

To determine the thread size, you need to know both dimensions Threads Per Inch and Outside Diameter (TPI and OD). You can look at any Akron Brass swivel for a 3 letter code for reference (except NH).

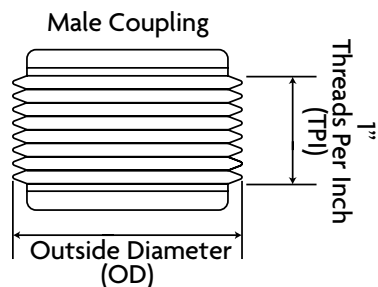



The diagram shows a side view of a pumper truck with various components labeled for technical specification. The labels and their corresponding lines are as follows:

- Scene Lights** (with poles & Portable)
- Reels**
- Monitors & Nozzles**
- Scene Lights**
- Brow & Marker Lights**
- Interior Dome & Stepwell Lights**
- Perimeter Warning Lights**
- Valves, Fittings & Plumbing Hardware**
- Compartment/Pump Panel Lights**
- Marker & Ground Illumination Lights**
- DOT Lights, Step Area Lights & License Plate Light**
- Multiplexing (including Display Preference)**
- Loose Equipment (i.e. Spanner Wrenches, Portable Monitors, Gate Valves)**



**Tested... Proven... Trusted.**



## Reels

- ERWC Electric Rewind Cord Reels ..... Quantity \_\_\_\_\_

## Monitors & Nozzles

### Monitors-Electric

- 3440 DeckMaster ..... Quantity \_\_\_\_\_
- 3600 Optional Wireless Remote Control ..... Quantity \_\_\_\_\_
- 3406 Optional 12" Electric Riser ..... Quantity \_\_\_\_\_
- 3482 StreamMaster II (1250 gpm) ..... Quantity \_\_\_\_\_
- 3480 StreamMaster II (2000 gpm) ..... Quantity \_\_\_\_\_

### Nozzle - Electric

- 1578 SaberMaster ..... Quantity \_\_\_\_\_
- 5177 Akromatic 1250 ..... Quantity \_\_\_\_\_
- 5178 Akromatic 2000 ..... Quantity \_\_\_\_\_

### Monitors-Manual

- 3416 Apollo - Single Inlet ..... Quantity \_\_\_\_\_
- 3423 Apollo - Dual Inlet ..... Quantity \_\_\_\_\_
- 3431 Apollo HiRiser ..... Quantity \_\_\_\_\_
- 3483 StreamMaster II (1250 gpm) ..... Quantity \_\_\_\_\_
- 3431 StreamMaster II (2000 gpm) ..... Quantity \_\_\_\_\_

### Nozzle - Manual

- 5160 Akromatic 1250 ..... Quantity \_\_\_\_\_
- 1745 TurboMaster 750 ..... Quantity \_\_\_\_\_
- 1755 TurboMaster 1250 ..... Quantity \_\_\_\_\_
- 1757 Turbomaster 1000 ..... Quantity \_\_\_\_\_
- 2499 Stacked Tips w/3485 Stream Shaper ..... Quantity \_\_\_\_\_
- 3499 Stacked Tips w/3485 Stream Shaper ..... Quantity \_\_\_\_\_

## Valve, Fittings & Plumbing Hardware

- 57 Drain Valve- 3/4" for use with each discharge valve ..... Quantity \_\_\_\_\_
- 53 Relief Valve - one per pump ..... Quantity \_\_\_\_\_
- 345 Caps ..... Quantity \_\_\_\_\_
- 347 Plugs ..... Quantity \_\_\_\_\_
- 630 Discharge Elbow ..... Quantity \_\_\_\_\_
- 635 Crosslay Swivel Elbow ..... Quantity \_\_\_\_\_
- 650 Swivel Joints ..... Quantity \_\_\_\_\_
- 1477 Push-Pull Rod - Remote Valve Control ..... Quantity \_\_\_\_\_
- 3061, 3096, & 3126 Foam System - Truck By-Pass Eductor Foam System ..... Quantity \_\_\_\_\_
- 3128 Off-Truck Foam Access Kit ..... Quantity \_\_\_\_\_
- 7940 - 7960 Butterfly ..... Quantity \_\_\_\_\_
- 7982-7983 Revolution Intake Valve ..... Quantity \_\_\_\_\_
- 8600 Electric Swing Out Valves ..... Quantity \_\_\_\_\_
- 8600 Gear Actuated Swing Out Valves ..... Quantity \_\_\_\_\_
- 8800 Swing Out Valves - Remote Actuated ..... Quantity \_\_\_\_\_
- 9300 Flow Meter ..... Quantity \_\_\_\_\_
- 9333 Valve Controller - Electric ..... Quantity \_\_\_\_\_
- 9335 Valve Controller - Electric ..... Quantity \_\_\_\_\_
- Valve Position Indicator- Gear Actuated Valves ..... Quantity \_\_\_\_\_

## Scene Lights (Cab or Body Surface Mount)

- 3862 3 x 7 HID ..... Quantity \_\_\_\_\_
- 4662 4 x 6 HID ..... Quantity \_\_\_\_\_
- 7862 7x 9 HID ..... Quantity \_\_\_\_\_
- 3800 Series 3 x 7 Halogen ..... Quantity \_\_\_\_\_
- 4600 Series 4 x 6 Halogen ..... Quantity \_\_\_\_\_
- 7800 Series 7 x9 Halogen ..... Quantity \_\_\_\_\_
- V375 Diamondback 3 x 7 LED (600 lumen) ..... Quantity \_\_\_\_\_
- V465 Diamondback 4 x 6 LED (600 lumen) ..... Quantity \_\_\_\_\_
- V795 Diamondback 7 x 9 LED (1,200 lumen) ..... Quantity \_\_\_\_\_

## Scene Lights (with Poles & Portable)

- ELRE-SLDC Revel® LED (14K Lumens) ..... Quantity \_\_\_\_\_
- ELRE-XLDC Revel® LED (14K Lumens) ..... Quantity \_\_\_\_\_
- ELSS-SLDC SceneStar® LED (14K Lumens) ..... Quantity \_\_\_\_\_
- ELSS-XLDC SceneStar® LED (19K Lumens) ..... Quantity \_\_\_\_\_
- ELSS-XLAC SceneStar® LED (20K Lumens 120V) ..... Quantity \_\_\_\_\_
- ELSS-XLAC2 SceneStar® LED (20K Lumens 240) ..... Quantity \_\_\_\_\_
- ELBE-500 Low Profile 500W 120V ..... Quantity \_\_\_\_\_
- ELBE-750 Low Profile Beta 750W 120V ..... Quantity \_\_\_\_\_
- ELST-500 ST series 500W 120V ..... Quantity \_\_\_\_\_
- ELST-750 ST series 750W 120V ..... Quantity \_\_\_\_\_

## Cab Brow Scene Lights

- ELRE-SLDC Revel® LED (14K Lumens) ..... Quantity \_\_\_\_\_
- ELRE-XLDC Revel® LED (14K Lumens) ..... Quantity \_\_\_\_\_
- ELSS-SLDC SceneStar® LED (14K Lumens) ..... Quantity \_\_\_\_\_
- ELSS-XLDC SceneStar® LED (19K Lumens) ..... Quantity \_\_\_\_\_
- ELSS-XLAC SceneStar® LED (20K Lumens 120V) ..... Quantity \_\_\_\_\_
- ELSS-XLAC2 SceneStar® LED (20K Lumens 240) ..... Quantity \_\_\_\_\_
- DOT Lights, Step Area & License Plate Lights
- 9186-5525 Series 4-Inch Round LED Red Lights for Stop/Tail/Turn ..... Quantity \_\_\_\_\_
- 9186-5526 Series 4-Inch Round LED Lights for Backup ..... Quantity \_\_\_\_\_
- 3884 Series Tri-Cluster Lamp Assemblies 3X7 ..... Quantity \_\_\_\_\_
- 4684 Series Tri-Cluster Lamp Assemblies 4X6 ..... Quantity \_\_\_\_\_
- 4681 Series Tri Cluster Lamp Assemblies Horizontal 4X6 ..... Quantity \_\_\_\_\_
- 3894 Series Quad Cluster Lamp Assemblies 3X7 ..... Quantity \_\_\_\_\_
- 9186-23882 Series License Illuminator or Control Area Light ..... Quantity \_\_\_\_\_
- 8102 Series LED License Illuminator ..... Quantity \_\_\_\_\_

## Marker & Ground Illumination Lights

- 5180 Series 1.5" x 3.5" Rectangular LED ..... Quantity \_\_\_\_\_
- 9186-1500 Series 1.1" x 2.59" LED ..... Quantity \_\_\_\_\_
- 9186-5000 Series 4" Round LED ..... Quantity \_\_\_\_\_
- 9186-1585 Series Truck Style LED ..... Quantity \_\_\_\_\_
- 5060 Series Triangular Incandescent or LED ..... Quantity \_\_\_\_\_
- 9185 -40034 Series 5.5" Round Lamp ..... Quantity \_\_\_\_\_

## Compartment & Pump Panel Lights

- 9185-60004 Series 5.5" Oval LED or Incandescent ..... Quantity \_\_\_\_\_
- 9186-2301 Series LED Courtesy Lamp ..... Quantity \_\_\_\_\_
- 9186-5515 Series 4" Flange Mount LED ..... Quantity \_\_\_\_\_
- 2630 Series 2.5" x 6" Incandescent ..... Quantity \_\_\_\_\_
- 2631 Series 2.5" x 6" LED ..... Quantity \_\_\_\_\_

## Perimeter Warning Lights

- V Series Diamondback LED Lighting
  - V34 Diamondback 3X4 ..... Quantity \_\_\_\_\_
  - V37 Diamondback 3X7 ..... Quantity \_\_\_\_\_
  - V46 Diamondback 4X6 ..... Quantity \_\_\_\_\_
  - V79 Diamondback 7X9 ..... Quantity \_\_\_\_\_

## Interior Dome & Stepwell Light

- 8049 Series Clear 8" LED ..... Quantity \_\_\_\_\_
- 8081/8080 Series Red/Clear LED ..... Quantity \_\_\_\_\_
- 9185-40003 Series Interior Light ..... Quantity \_\_\_\_\_
- 9186-8560 Series Stepwell Lamp ..... Quantity \_\_\_\_\_
- 9186-23882-30 Incandescent Stepwell Light ..... Quantity \_\_\_\_\_

## Multiplexing

- Vista Display ..... Quantity \_\_\_\_\_
- Vista Touch Screen Display ..... Quantity \_\_\_\_\_
- Programmable On Demand Switches (PODS) ..... Quantity \_\_\_\_\_
- 6500 Series Camera ..... Quantity \_\_\_\_\_
- Integrated GPS System ..... Quantity \_\_\_\_\_
- 6204-0000-00 Occupant Restraint Indicator ..... Quantity \_\_\_\_\_
- 6444-0000-00 Vehicle Data Recorder (VDR) ..... Quantity \_\_\_\_\_

## Loose Equipment

- EJBX Series Electrical Junction Box & Brackets ..... Quantity \_\_\_\_\_
- ERCP Series Electric Cord Reel ..... Quantity \_\_\_\_\_
- Turbojet, Ultrajet, Assault & ProVenger Handline Nozzles ..... Quantity \_\_\_\_\_
- Mercury, MercuryMaster & Ozzie Portable Ground Monitors ..... Quantity \_\_\_\_\_
- Foam Tube ..... Quantity \_\_\_\_\_
- 340 Barrel Suction Strainer ..... Quantity \_\_\_\_\_
- 443 Combination Wrench Holder with (2) Spanner wrenches and (1) Hydrant Wrench ..... Quantity \_\_\_\_\_
- 448 Combination Wrench Holder with (2) Spanners Wrenches ..... Quantity \_\_\_\_\_
- 15 or 17 Hydrant Wrenches ..... Quantity \_\_\_\_\_
- 335 Double Female Adapters ..... Quantity \_\_\_\_\_
- 336 Double Male Adapters ..... Quantity \_\_\_\_\_
- 1583 Gated Siamese ..... Quantity \_\_\_\_\_
- 2583 Gated Siamese ..... Quantity \_\_\_\_\_
- 1581 Gated Wye ..... Quantity \_\_\_\_\_
- 2581 Gated Wye ..... Quantity \_\_\_\_\_
- 2285 Gate Valve ..... Quantity \_\_\_\_\_
- 2286 Gate Valve ..... Quantity \_\_\_\_\_

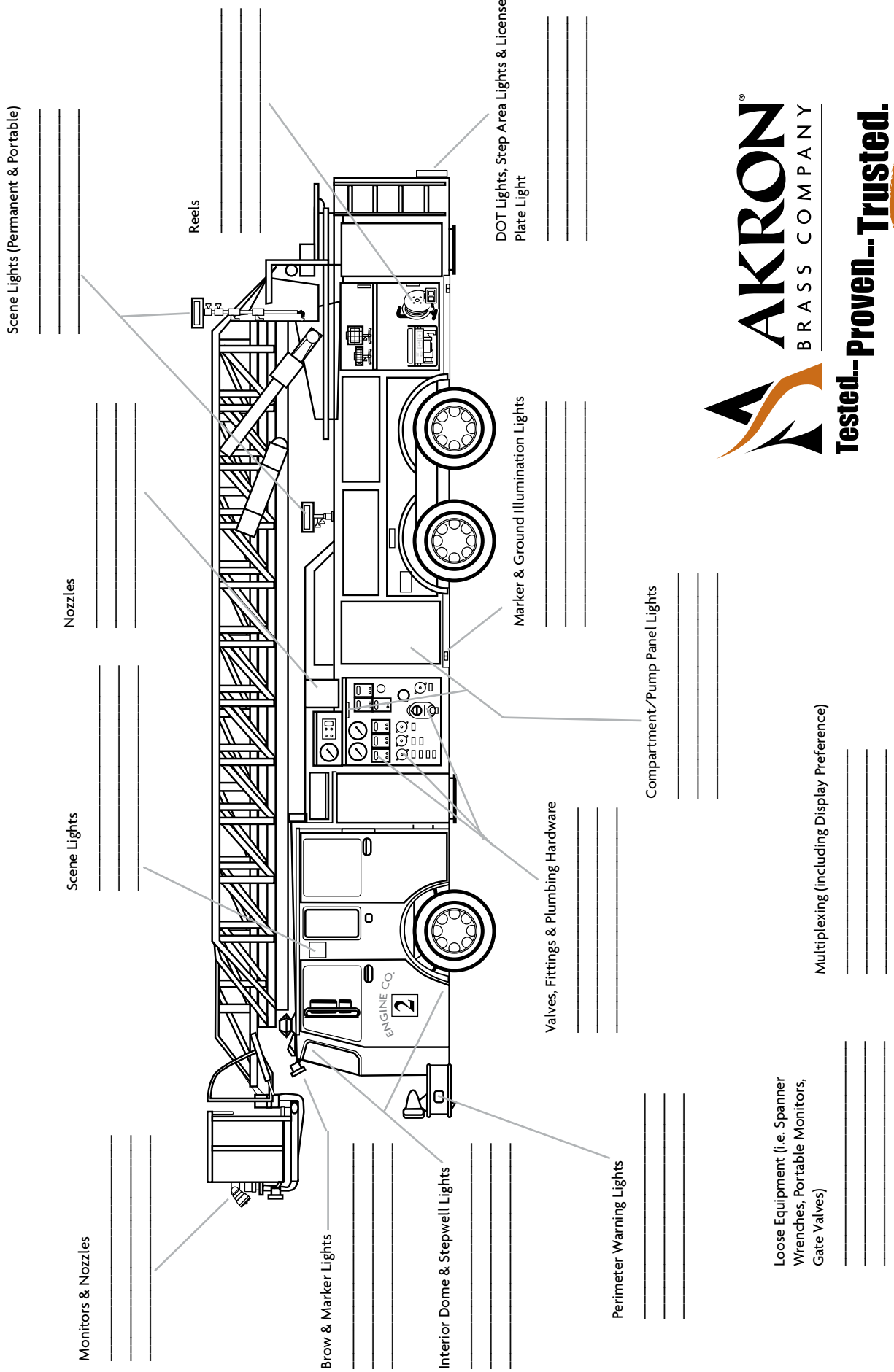

Loose Equipment (i.e. Spanner  
Wrenches, Portable Monitors,  
Gate Valves)

Multiplexing (including Display Preference)





## Reels

- ERWC Electric Rewind Cord Reels ..... Quantity \_\_\_\_\_

## Monitors & Nozzles

### Monitors-Electric

- 3480 StreamMaster II (2000 gpm) ..... Quantity \_\_\_\_\_
- 3600 Optional Wireless Remote Control ..... Quantity \_\_\_\_\_

### Nozzle - Electric

- 1578 SaberMaster ..... Quantity \_\_\_\_\_
- 5177 Akromatic 1250 ..... Quantity \_\_\_\_\_
- 5178 Akromatic 2000 ..... Quantity \_\_\_\_\_

### Monitors -Manual

- 3481 StreamMaster II (2000 gpm) ..... Quantity \_\_\_\_\_

### Nozzle - Manual

- 5160 Akromatic 1250 ..... Quantity \_\_\_\_\_
- 1745 TurboMaster 750 ..... Quantity \_\_\_\_\_
- 1755 TurboMaster 1250 ..... Quantity \_\_\_\_\_
- 1757 Turbomaster 1000 ..... Quantity \_\_\_\_\_
- 2499 Stacked Tips w/3485 Stream Shaper ..... Quantity \_\_\_\_\_
- 3499 Stacked Tips w/3485 Stream Shaper ..... Quantity \_\_\_\_\_

### Ladder Pipe \*For Customers w/o Plumbed Waterways on Ladders

- 1495 Ladder Pipe ..... Quantity \_\_\_\_\_

## Valve, Fittings & Plumbing Hardware

- 57 Drain Valve- 3/4" for use with each discharge valve ..... Quantity \_\_\_\_\_
- 53 Relief Valve - one per pump ..... Quantity \_\_\_\_\_
- 345 Caps ..... Quantity \_\_\_\_\_
- 347 Plugs ..... Quantity \_\_\_\_\_
- 630 Discharge Elbow ..... Quantity \_\_\_\_\_
- 635 Crosslay Swivel Elbow ..... Quantity \_\_\_\_\_
- 650 Swivel Joints ..... Quantity \_\_\_\_\_
- 1477 Push-Pull Rod - Remote Valve Control ..... Quantity \_\_\_\_\_
- 3061, 3096, & 3126 Foam System - Truck By-Pass Eductor Foam System ..... Quantity \_\_\_\_\_
- 3128 Off-Truck Foam Access Kit ..... Quantity \_\_\_\_\_
- 7940 - 7960 Butterfly ..... Quantity \_\_\_\_\_
- 7982-7983 Revolution Intake Valve ..... Quantity \_\_\_\_\_
- 8600 Electric Swing Out Valves ..... Quantity \_\_\_\_\_
- 8600 Gear Actuated Swing Out Valves ..... Quantity \_\_\_\_\_
- 8800 Swing Out Valves - Remote Actuated ..... Quantity \_\_\_\_\_
- 9300 Flow Meter ..... Quantity \_\_\_\_\_
- 9333 Valve Controller - Electric ..... Quantity \_\_\_\_\_
- 9335 Valve Controller - Electric ..... Quantity \_\_\_\_\_
- Valve Position Indicator- Gear Actuated Valves ..... Quantity \_\_\_\_\_

## Scene Lights (Cab or Body Surface Mount)

- 3862 3 x 7 HID ..... Quantity \_\_\_\_\_
- 4662 4 x 6 HID ..... Quantity \_\_\_\_\_
- 7862 7x 9 HID ..... Quantity \_\_\_\_\_
- 3800 Series 3 x 7 Halogen ..... Quantity \_\_\_\_\_
- 4600 Series 4 x 6 Halogen ..... Quantity \_\_\_\_\_
- 7800 Series 7 x 9 Halogen ..... Quantity \_\_\_\_\_
- V375 Diamondback 3 x 7 LED (600 lumen) ..... Quantity \_\_\_\_\_
- V465 Diamondback 4 x 6 LED (600 lumen) ..... Quantity \_\_\_\_\_
- V795 Diamondback 7 x 9 LED (1,200 lumen) ..... Quantity \_\_\_\_\_

## Scene Lights (with Poles & Portable)

- ELRE-SLDC Revel® LED (14K Lumens) ..... Quantity \_\_\_\_\_
- ELRE-XLDC Revel® LED (14K Lumens) ..... Quantity \_\_\_\_\_
- ELSS-SLDC SceneStar® LED (14K Lumens) ..... Quantity \_\_\_\_\_
- ELSS-XLDC SceneStar® LED (19K Lumens) ..... Quantity \_\_\_\_\_
- ELSS-XLAC SceneStar® LED (20K Lumens 120V) ..... Quantity \_\_\_\_\_
- ELSS-XLAC2 SceneStar® LED (20K Lumens 240) ..... Quantity \_\_\_\_\_
- ELBE-500 Low Profile 500W 120V ..... Quantity \_\_\_\_\_
- ELBE-750 Low Profile Beta 750W 120V ..... Quantity \_\_\_\_\_
- ELST-500 ST series 500W 120V ..... Quantity \_\_\_\_\_
- ELST-750 ST series 750W 120V ..... Quantity \_\_\_\_\_

## Cab Brow Scene Lights

- ELRE-SLDC Revel® LED (14K Lumens) ..... Quantity \_\_\_\_\_
- ELRE-XLDC Revel® LED (14K Lumens) ..... Quantity \_\_\_\_\_
- ELSS-SLDC SceneStar® LED (14K Lumens) ..... Quantity \_\_\_\_\_
- ELSS-XLDC SceneStar® LED (19K Lumens) ..... Quantity \_\_\_\_\_
- ELSS-XLAC SceneStar® LED (20K Lumens 120V) ..... Quantity \_\_\_\_\_
- ELSS-XLAC2 SceneStar® LED (20K Lumens 240) ..... Quantity \_\_\_\_\_

## DOT Lights, Step Area & License Plate Lights

- 9186-5525 Series 4-Inch Round LED Red Lights for Stop/Tail/Turn ..... Quantity \_\_\_\_\_
- 9186-5526 Series 4-Inch Round LED Lights for Backup ..... Quantity \_\_\_\_\_
- 3884 Series Tri-Cluster Lamp Assemblies 3X7 ..... Quantity \_\_\_\_\_
- 4684 Series Tri-Cluster Lamp Assemblies 4X6 ..... Quantity \_\_\_\_\_
- 4681 Series Tri Cluster Lamp Assemblies Horizontal 4X6 ..... Quantity \_\_\_\_\_
- 3894 Series Quad Cluster Lamp Assemblies 3X7 ..... Quantity \_\_\_\_\_
- 9186-23882 Series License Illuminator or Control Area Light ..... Quantity \_\_\_\_\_
- 8102 Series LED License Illuminator ..... Quantity \_\_\_\_\_

## Marker & Ground Illumination Lights

- 5180 Series 1.5" x 3.5" Rectangular LED ..... Quantity \_\_\_\_\_
- 9186-1500 Series 1.1" x 2.59" LED ..... Quantity \_\_\_\_\_
- 9186-5000 Series 4" Round LED ..... Quantity \_\_\_\_\_
- 9186-1585 Series Truck Style LED ..... Quantity \_\_\_\_\_
- 5060 Series Triangular Incandescent or LED ..... Quantity \_\_\_\_\_
- 9185 -40034 Series 5.5" Round Lamp ..... Quantity \_\_\_\_\_

## Compartment & Pump Panel Lights

- 9185-60004 Series 5.5" Round LED or Incandescent ..... Quantity \_\_\_\_\_
- 9186-2301 Series LED Courtesy Lamp ..... Quantity \_\_\_\_\_
- 9186-5515 Series 4" Flange Mounted LED ..... Quantity \_\_\_\_\_
- 2630 Series 2.5" x 6" Incandescent ..... Quantity \_\_\_\_\_
- 2631 Series 2.5" x 6" LED ..... Quantity \_\_\_\_\_

## Perimeter Warning Lights

- V Series Diamondback LED Lighting
  - V34 Diamondback 3X4 ..... Quantity \_\_\_\_\_
  - V37 Diamondback 3X7 ..... Quantity \_\_\_\_\_
  - V46 Diamondback 4X6 ..... Quantity \_\_\_\_\_
  - V79 Diamondback 7X9 ..... Quantity \_\_\_\_\_

## Interior Dome & Stepwell Light

- 8049 Series Clear 8" LED ..... Quantity \_\_\_\_\_
- 8080/8081 Series Red/Clear LED ..... Quantity \_\_\_\_\_
- 9185-40003 Series Interior Light ..... Quantity \_\_\_\_\_
- 9186-8560 Series Stepwell Lamp ..... Quantity \_\_\_\_\_
- 9186-23882-30 Incandescent Stepwell Light ..... Quantity \_\_\_\_\_

## Multiplexing

- Vista Display ..... Quantity \_\_\_\_\_
- Vista Touch Screen Display ..... Quantity \_\_\_\_\_
- Programmable On Demand Switches (PODS) ..... Quantity \_\_\_\_\_
- 6500 Series Camera ..... Quantity \_\_\_\_\_
- Integrated GPS System ..... Quantity \_\_\_\_\_
- 6204-0000-00 Occupant Restraint Indicator ..... Quantity \_\_\_\_\_
- 6444-0000-00 Vehicle Data Recorder (VDR) ..... Quantity \_\_\_\_\_

## Loose Equipment

- EJBX Series Electrical Junction Box & Brackets ..... Quantity \_\_\_\_\_
- ERCP Series Electric Cord Reel ..... Quantity \_\_\_\_\_
- Turbojet, Ultrajet, Assault & ProVenger Handline Nozzles ..... Quantity \_\_\_\_\_
- Mercury, MercuryMaster & Ozzie Portable Ground Monitors ..... Quantity \_\_\_\_\_
- Foam Tube ..... Quantity \_\_\_\_\_
- 340 Barrel Suction Strainer ..... Quantity \_\_\_\_\_
- 443 Combination Wrench Holder with
  - (2) Spanner wrenches and (1) Hydrant Wrench ..... Quantity \_\_\_\_\_
- 448 Combination Wrench Holder with (2) Spanners Wrenches ..... Quantity \_\_\_\_\_
- 15 or 17 Hydrant Wrenches ..... Quantity \_\_\_\_\_
- 335 Double Female Adapters ..... Quantity \_\_\_\_\_
- 336 Double Male Adapters ..... Quantity \_\_\_\_\_
- 1583 Gated Siamese ..... Quantity \_\_\_\_\_
- 2583 Gated Siamese ..... Quantity \_\_\_\_\_
- 1581 Gated Wye ..... Quantity \_\_\_\_\_
- 2581 Gated Wye ..... Quantity \_\_\_\_\_
- 2285 Gate Valve ..... Quantity \_\_\_\_\_
- 2286 Gate Valve ..... Quantity \_\_\_\_\_

Hand Line Nozzle

Scene Lighting

Valves & Plumbing Hardware

Marker Lights & Reflectors

Compartment Lights

Loose Equipment  
(Spanner Wrenches, Gate Valves)

Warning Lights

Front Bumper Monitor & Nozzle

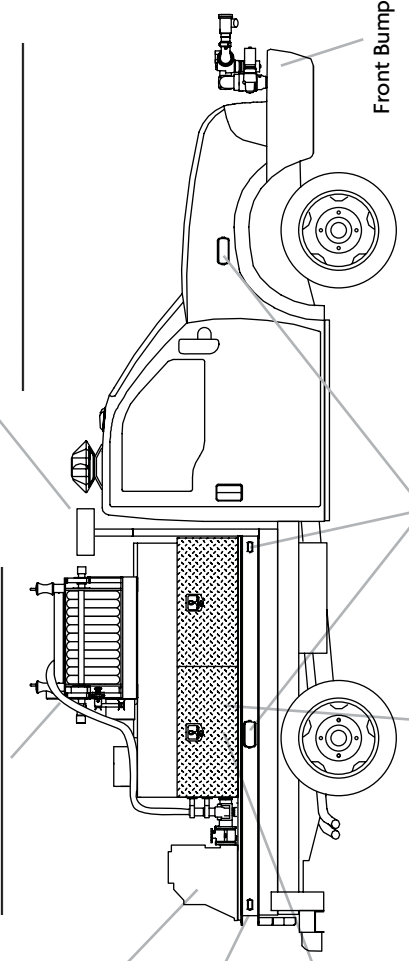

\_\_\_\_\_

\_\_\_\_\_

\_\_\_\_\_

\_\_\_\_\_

\_\_\_\_\_

\_\_\_\_\_

\_\_\_\_\_

\_\_\_\_\_

\_\_\_\_\_

\_\_\_\_\_

\_\_\_\_\_

\_\_\_\_\_

\_\_\_\_\_

\_\_\_\_\_

\_\_\_\_\_

\_\_\_\_\_

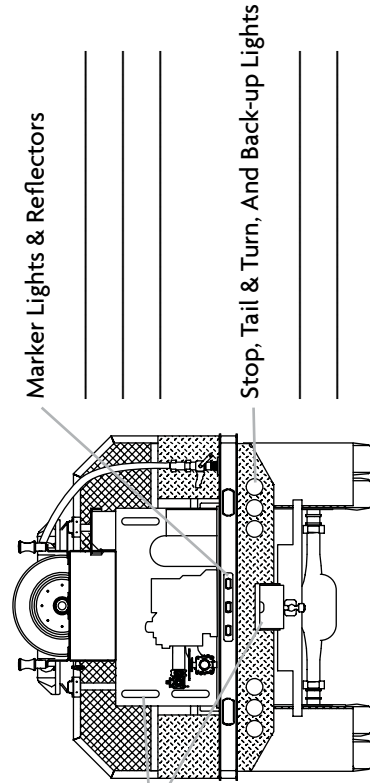

Marker Lights & Reflectors

Stop, Tail & Turn, And Back-up Lights

License Plate & Work Area Lights

\_\_\_\_\_

\_\_\_\_\_

\_\_\_\_\_

\_\_\_\_\_

\_\_\_\_\_

\_\_\_\_\_



**Tested... Proven... Trusted.**

# Technical Data: Brush Truck Components Work Sheet



## Valves & Plumbing Hardware

- 8800 Series Heavy-Duty Swing-Out Valve, 1-inch for tank fill and hose reel discharge, with TSC handle.....Quantity: \_\_\_\_\_
- 8800 Series Heavy-Duty Swing-Out Valve, 1.5-inch or 2-inch for pre-connect with TSC handle.....Quantity: \_\_\_\_\_
- 8800 Series Heavy-Duty Swing-Out Valve, 2.5-inch for suction with TSC handle.....Quantity: \_\_\_\_\_
- 8800 Series Heavy-Duty Swing-Out Valve, 2.5-inch or 3-inch for tank-to-pump with TSC handle.....Quantity: \_\_\_\_\_
- Style 635 90-degree swivel for 1.5-inch pre-connect.....Quantity: \_\_\_\_\_
- Style 7 drain valve.....Quantity: \_\_\_\_\_

## Handline Nozzles

- 1030 1-inch Forestry Nozzle.....Quantity: \_\_\_\_\_
- 1700 1-inch Aussie Bush Nozzle.....Quantity: \_\_\_\_\_
- 1702 1-inch Turbojet with PG.....Quantity: \_\_\_\_\_
- 2103 1-inch Shut-Off with Style 1410 Straight Tip.....Quantity: \_\_\_\_\_
- 4802 1-inch Assault.....Quantity: \_\_\_\_\_

## Monitor & Nozzle

- 3463 FireFox monitor, Style 3293 nozzle & joystick.....Quantity: \_\_\_\_\_
- 3462 Forestry Monitor, Style 3293 nozzle & joystick.....Quantity: \_\_\_\_\_

## Perimeter Warning Lights

- V Series Diamondback LED Lighting
  - V26 Diamondback 2X6.....Quantity: \_\_\_\_\_
  - V34 Diamondback 3X4.....Quantity: \_\_\_\_\_
  - V37 Diamondback 3X7.....Quantity: \_\_\_\_\_
  - V46 Diamondback 4X6.....Quantity: \_\_\_\_\_
  - V79 Diamondback 7X9.....Quantity: \_\_\_\_\_

## Accessories & Hand Tools

- 339 2.5-inch basket strainer.....Quantity: \_\_\_\_\_
- 448 2-wrench holder with two (2) Style 10 wrenches.....Quantity: \_\_\_\_\_

## Reels

- Electric Rewind Cord Reels.....Quantity: \_\_\_\_\_

## Scene Lights (with Poles & Portable)

- ELRE-SLDC Revel® LED (14K Lumens).....Quantity: \_\_\_\_\_
- ELRE-XLDC Revel® LED (14K Lumens).....Quantity: \_\_\_\_\_
- ELSS-SLDC SceneStar® LED (14K Lumens).....Quantity: \_\_\_\_\_
- ELSS-XLDC SceneStar® LED (19K Lumens).....Quantity: \_\_\_\_\_
- ELSS-XLAC SceneStar® LED (20K Lumens 120V).....Quantity: \_\_\_\_\_
- ELSS-XLAC2 SceneStar® LED (20K Lumens 240).....Quantity: \_\_\_\_\_
- ELBE-500 Low Profile 500W 120V.....Quantity: \_\_\_\_\_
- ELBE-750 Low Profile Beta 750W 120V.....Quantity: \_\_\_\_\_
- ELST-500 ST series 500W 120V.....Quantity: \_\_\_\_\_
- ELST-750 ST series 750W 120V.....Quantity: \_\_\_\_\_

## Scene Lights (Cab or Body Surface Mount)

- 3862 3 x 7 HID.....Quantity: \_\_\_\_\_
- 4662 4 x 6 HID.....Quantity: \_\_\_\_\_
- 7862 7x 9 HID.....Quantity: \_\_\_\_\_
- 3800 Series 3 x 7 Halogen.....Quantity: \_\_\_\_\_
- 4600 Series 4 x 6 Halogen.....Quantity: \_\_\_\_\_
- 7800 Series 7 x9 Halogen.....Quantity: \_\_\_\_\_
- V375 Diamondback 3"x7" LED.....Quantity: \_\_\_\_\_
- V465 Diamondback 4"x6" LED.....Quantity: \_\_\_\_\_
- V795 Diamondback 7"x9" LED.....Quantity: \_\_\_\_\_

## DOT & Utility Lighting

- 5180 Series Rectangular LED Red Marker Lamps.....Quantity: \_\_\_\_\_
- 5170 Series Rectangular LED Amber Marker Lamps.....Quantity: \_\_\_\_\_
- 9186-5525 Series 4-inch Round LED Red Lights for Stop/Tail/Turn.....Quantity: \_\_\_\_\_
- 9186-5526 Series 4-inch Round LED Clear Lights for Back-Up.....Quantity: \_\_\_\_\_
- 3884 Series Tri-Cluster Lamp Assemblies
  - Incandescent.....Quantity: \_\_\_\_\_
  - LED.....Quantity: \_\_\_\_\_
- 9186-078 Series Oblong Reflectors.....Quantity: \_\_\_\_\_
- 9186-23882-30 License Illuminator or Control Area Light.....Quantity: \_\_\_\_\_
- 2630/2631 Series Compartment or Control Area Light
  - Incandescent.....Quantity: \_\_\_\_\_
  - LED.....Quantity: \_\_\_\_\_



4 ..... 86	417..... 22	796 ..... 32	1582 ..... 88
7 ..... 86	438 ..... 22	797 ..... 32	1583..... 89
10 ..... 152	439 ..... 23	866 ..... 31	1602 ..... 19
13..... 152	441 ..... 153	911..... 54	1616..... 19
14..... 152	442 ..... 153	922 ..... 54	1700 ..... 25
15..... 152	443 ..... 153	1030 ..... 25	1701..... 8
17..... 152	446 ..... 153	1034 ..... 28	1702 ..... 8
19..... 152	447 ..... 153	1048 ..... 28	1703 ..... 8
25 ..... 152	448 ..... 153	1078 ..... 156	1704 ..... 8
35 ..... 96	449 ..... 153	1088 ..... 27	1711..... 8
39 ..... 153	485 ..... 23	1125..... 20	1714..... 8
40 ..... 153	489 ..... 22, 53, 59, 65, 70, 71	1141 ..... 21	1715..... 8
41..... 153	499 ..... 64	1256 ..... 89	1716..... 8
42 ..... 153	535 ..... 27	1260 ..... 88	1717..... 8
44 ..... 95	536 ..... 27	1262 ..... 89	1718..... 8
46 ..... 152	538 ..... 27	1267 ..... 89	1720 ..... 8
50 ..... 152	583 ..... 157	1410..... 22	1722 ..... 9
53..... 86	588 ..... 155	1417..... 22	1723..... 9
57 ..... 86	589 ..... 155	1420 ..... 23	1724 ..... 9
78 ..... 157	624 ..... 32	1440 ..... 21	1725 ..... 10
101..... 82	627 ..... 87	1441..... 21	1726 ..... 10
102 ..... 82	630 ..... 154	1442 ..... 21, 154	1727 ..... 10
262 ..... 89	631..... 154	1443 ..... 21	1728 ..... 10
285 ..... 87	635 ..... 154	1445 ..... 21	1733..... 10
330 ..... 154	638 ..... 32	1446 ..... 21	1734..... 9
335 ..... 154	650 ..... 154	1477 ..... 82	1735..... 9
336 ..... 154	730 ..... 47	1478 ..... 82	1736 ..... 10
337..... 154	737 ..... 33	1482 ..... 88	1737..... 9
338 ..... 154	738 ..... 33	1495 ..... 59	1738 ..... 10
339 ..... 155	753 ..... 26	1496 ..... 59	1744 ..... 10
340 ..... 155	770 ..... 32	1499 ..... 22	1745..... 35
345 ..... 154	772 ..... 155	1520 ..... 16	1755..... 35
347 ..... 154	773 ..... 155	1523..... 16	1757..... 35
350 ..... 156	790 ..... 32	1528 ..... 16	1762..... 9
352 ..... 155	791 ..... 32	1545 ..... 34, 53	1763..... 9
353..... 155	792 ..... 32	1573..... 88	1764 ..... 9
373..... 156	793 ..... 32	1578..... 34, 43, 44, 45, 56	1765..... 9
416 ..... 22	794 ..... 32	1581..... 88	1766 ..... 9



1767.....	9	2430.....	21	3128.....	91	3503.....	57
1772.....	8	2431.....	21	3250.....	90	3505.....	57
1820.....	5	2432.....	21	3292.....	77	3523.....	63
1828.....	87	2433.....	21	3293.....	33, 38, 41, 76	3524.....	64
2015.....	28	2441.....	153	3352.....	76	3525.....	64
2032.....	28	2442.....	153	3353.....	75	3526.....	64, 72
2033.....	28	2443.....	153	3354.....	75	3528.....	63, 72
2046.....	28	2446.....	153	3356.....	46, 74, 75	3530.....	69
2047.....	28	2447.....	153	3406.....	43	3531.....	72
2055.....	27	2448.....	153	3414.....	55	3563.....	71
2069.....	29	2498.....	23, 44, 45, 53, 56	3416.....	55	3580.....	48
2073.....	29	2499.....	23, 44, 45, 56	3419.....	56	3590.....	68
2074.....	29	2580.....	88	3421.....	55	3600.....	56, 76, 77
2077.....	29	2581.....	88	3423.....	55	3620.....	33
2101.....	21	2582.....	88	3426.....	59	3621.....	33
2102.....	21	2583.....	89	3430.....	58	3622.....	33
2108.....	21	2681.....	88	3431.....	57	3623.....	30
2115.....	21	2730.....	10	3433.....	57	3624.....	30
2116.....	21	2775.....	72	3437.....	65	3625.....	30
2120.....	90	2901.....	90	3440.....	43	3626.....	30
2125.....	21	3000.....	47	3443.....	53	3671.....	65
2126.....	21	3015.....	26	3446.....	53	3678.....	66
2127.....	21	3016.....	26	3450.....	77	3690.....	65
2129.....	21	3019.....	26	3462.....	40	3698.....	67
2130.....	21	3020.....	28, 29	3463.....	41, 76	3700.....	47
2151.....	63	3021.....	26	3470.....	58	3716.....	10
2171.....	38	3022.....	28	3475.....	62, 68	3721.....	10
2188.....	48	3023.....	29	3476.....	62, 68	3725.....	10
2189.....	48	3025.....	26	3479.....	42	3951.....	30
2225.....	28	3030.....	37	3480.....	45	3952.....	30
2285.....	87, 95	3060.....	90	3481.....	59	4039.....	39
2286.....	87	3071.....	90	3482.....	44	4040.....	39, 44, 45
2325.....	90	3095.....	90	3485.....	23, 44, 45, 56	4041.....	39
2328.....	90	3096.....	91	3488.....	23, 59, 65	4042.....	39, 45
2390.....	20	3097.....	91	3491.....	61	4116.....	19
2393.....	20	3120.....	30	3492.....	62	4445.....	39, 53
2415.....	28	3125.....	90	3493.....	70	4447.....	39, 53
2420.....	23, 53	3126.....	91	3499.....	23, 45	4450.....	35, 63, 64, 72

4452.....	35	4824.....	15	7940.....	85	718236.....	24
4460.....	35	4825.....	15	7945.....	85	718237.....	24
4461.....	35, 72	4826.....	15	7950.....	85	718238.....	24
4462.....	35	4827.....	15	7960.....	85	718239.....	24
4470.....	37	4830.....	15	7980.....	85	718240.....	24
4471.....	37	4834.....	15	7982.....	84	718279.....	24
4475.....	37	4835.....	15	7983.....	84	36000004.....	51
4478.....	37	4836.....	15	8620.....	79	36000015.....	51
4479.....	37	4837.....	15	8625.....	79	60350009.....	51
4480.....	37, 44, 45	4838.....	15	8630.....	79	60350012.....	51
4712.....	13	4862.....	14	8635.....	79	60350017.....	51, 71
4713.....	13	4863.....	14	8810.....	78	60370008.....	51
4714.....	13	4864.....	14	8815.....	78	60410008.....	51
4715.....	13	4865.....	14	8820.....	79	60410023.....	51
4716.....	13	4866.....	14	8825.....	79	60410028.....	51
4717.....	13	4867.....	14	8830.....	79	60410029.....	51
4718.....	13	5055.....	38, 62	8835.....	79	60410034.....	51
4720.....	13	5056.....	38	8840.....	80	60410035.....	51
4722.....	15	5071.....	34, 65	8910.....	78	60411000.....	51
4724.....	15	5075.....	34	8915.....	78	60411003.....	51
4726.....	15	5088.....	48	8920.....	79	60411005.....	51
4801.....	13	5147.....	39, 53	8925.....	79	60412001.....	51
4802.....	13	5148.....	39, 53	8930.....	79	60510002.....	51
4803.....	13	5150.....	39, 53	8935.....	79	60510005.....	51
4804.....	13	5160.....	34	8940.....	80	60510006.....	51
4808.....	26	5161.....	34	9100.....	97	OB53-0333-00.....	113, 133
4812.....	13	5170.....	34, 59	9200.....	156	OB53-1016-00.....	113, 133
4813.....	13	5176.....	44, 45	9201.....	157	OB53-1125-00.....	113, 133
4814.....	13	5177.....	34, 44, 45, 56, 75, 76	9202.....	157	OB80-2334-00.....	111, 130
4815.....	13	5178.....	34, 45, 75	9203.....	157	OB80-2335-00.....	111, 134
4816.....	13	6032.....	50	9210.....	157	OB80-2336-00.....	110, 111, 134
4817.....	13	6035.....	40, 56	9301.....	95	OB80-2337-00.....	111, 134
4818.....	13	6036.....	51, 71	9323.....	83	OB80-2495-00.....	130
4819.....	13	6037.....	40	9325.....	83	OC10-2228-10.....	127
4820.....	13	6041.....	56	9900.....	97	OC10-2228-30.....	127
4821.....	13	7675.....	82	718233.....	24	OC10-2228-40.....	127
4822.....	15	7725.....	83	718234.....	24	OC10-2313-00.....	115
4823.....	15	7875.....	82	718235.....	24	OC11-1223-00.....	127





OC12-1181-00 ..... 124	OD10-2316-00 ..... 115	OK90-2869-00 ..... 124	10105-1100-XX ..... 116
OC13-1125-00 ..... 127	OD10-2753-00 ..... 124	OK90-3101-00 ..... 130	10105-1200-XX ..... 116
OC14-1226-00 ..... 127	OD30-0377-00... 113, 120, 123, 133	OK90-3187-00 ..... 132	1013-1100-30 ..... 122
OC20-2170-30 ..... 134	OD30-0385-00... 113, 120, 123, 133	OK90-3307-00 ..... 118	1014-0000-00 ..... 116, 122
OC20-2177-30 ..... 134	OD30-1026-00 ..... 113, 123, 133	OK90-3308-00 ..... 118	1015-0000-00 ..... 116, 122
OC20-2184-30 ..... 134	OD30-1027-00 ..... 113, 123, 133	OK90-3442-00 ..... 132	1016-0000-00 ..... 122
OC20-2191-30 ..... 130	OD30-1092-00 ..... 124, 131	OK90-3448-00 ..... 128	1017-9000-10 ..... 116
OC20-2312-XX ..... 115	OD30-1136-00 ..... 113, 133	OK90-3462-00 ..... 104	1017-9000-20 ..... 116
OC20-2408-30 ..... 130	OD30-1137-00 ..... 113, 133	OK90-3717-00 ..... 126	1017-9000-30 ..... 122
OC20-3179-00 ..... 128	OE13-1878-00 ..... 127	OL40-1472-00 ..... 133	1020-5000-10 ..... 115
OC20-3601-00 ..... 111	OE17-3623-00 ..... 116	OL40-2020-00 ..... 103	1020-5000-20 ..... 115
OC20-3602-XX ..... 111	OE22-0327-00 ..... 113	OL40-2088-00 ..... 103	1020-5000-XX ..... 115
OC20-3603-XX ..... 111	OE22-1357-00 ..... 133	OL40-2597-00 ..... 108	1020-5030-XX ..... 115
OC20-3604-XX ..... 111	OE30-2262-12 ..... 115, 116	OL40-2806-02 ..... 102	1020-5090-XX ..... 115
OC20-3605-XX ..... 111	OE30-2262-23 ..... 115, 116	OL40-3528-00 ..... 118	1020-9000-10 ..... 115
OC63-1180-00 ..... 131	OE30-2262-37 ..... 122	OM10-1328-XX ..... 113	1020-9000-20 ..... 115
OC80-2684-30 ..... 122	OE93-1571-00 ..... 133	OM10-1330-XX ..... 113	1020-9030-XX ..... 115
OC80-2684-XX ..... 116	OJ10-0393-00 ..... 131	OM10-1428-XX ..... 113	1020-9090-XX ..... 115
OC90-0350-33 ..... 123, 133	OJ10-0503-00 ..... 131	ON00-1471-00 ..... 133	1021-0000-00 ..... 115
OC90-0350-XX ..... 113, 120	OJ10-1200-00 ..... 126	ON60-2508-00 ..... 110	2350-0000-00 ..... 118
OC90-0351-XX ..... 120	OJ10-2161-BK ..... 125	ON70-1519-03 ..... 108	2351-0100-00 ..... 118
OC90-0352-XX ..... 120	OJ10-2161-GY ..... 125	ON70-1519-04 ..... 108	2352-0100-00 ..... 118
OC90-1028-33 ..... 123, 133	OJ50-1505-01 ..... 102	ON80-2485-00 ..... 128	2630-0000-30 ..... 130
OC90-1028-XX ..... 113	OK14-2073-00-00 ..... 108	OQ20-1736-00 ..... 103	2631-0000-30 ..... 130
OC90-1138-33 ..... 133	OK90-0336-00 ..... 113, 120, 123	OR13-0614-00 ..... 108	2710-0100-20 ..... 124
OC90-1138-XX ..... 113	OK90-0337-00 ..... 120	OR13-2557-00 ..... 108	2710-1100-20 ..... 124
OD00-1458-00 ..... 133	OK90-1291-20 ..... 118	OU10-0715-00 ..... 108	3200-0000-11 ..... 114
OD00-1569-00 ..... 133	OK90-1601-00 ..... 125	1000-1100-20 ..... 116	3200-0000-13 ..... 114
OD00-1570-00 ..... 133	OK90-1803-00 ..... 125	1000-1106-20 ..... 116	3201-0000-11 ..... 114
OD10-0334-00 ..... 113, 133	OK90-1806-00 ..... 133	1002-0000-xx ..... 116	3201-0000-13 ..... 114
OD10-1025-00 ..... 113, 133	OK90-2280-00 ..... 105	1003-0000-80 ..... 128	3811-0000-33 ..... 133
OD10-1035-00 ..... 133	OK90-2281-00 ..... 105	1003-0000-XX ..... 116	3812-0000-33 ..... 133
OD10-1135-00 ..... 113	OK90-2282-00 ..... 106, 108	1003-1000-30 ..... 122	3821-0000-12 ..... 113
OD10-1176-00 ..... 124, 131	OK90-2286-00 ..... 105	1005-1100-XX ..... 116	3841-0000-10 ..... 119
OD10-1208-00 ..... 126	OK90-2310-00 ..... 102	1010-1100-XX ..... 116	3841-0000-20 ..... 119
OD10-1530-00 ..... 126	OK90-2311-00 ..... 103	1010-1120-10 ..... 116	3841-0000-21 ..... 119
OD10-1630-00 ..... 125	OK90-2763-00 ..... 108	1010-1120-XX ..... 116	3841-0000-22 ..... 119
OD10-1977-00 ..... 115	OK90-2783-00 ..... 106	1010-1126-XX ..... 116	3841-0000-30 ..... 123

3842-0000-10 .....119	4641-0000-30 ..... 123	5180-0110-20 ..... 125	8046-0300-80..... 128
3842-0000-20 .....119	4642-0000-10 ..... 120	5213-0100-10 ..... 126	8046-0320-80 ..... 128
3842-0000-21 .....119	4642-0000-20 ..... 120	5213-0100-20 ..... 126	8052-0000-30 ..... 128
3842-0000-22 .....119	4642-0000-21 ..... 120	6000-0000-04 ..... 105	8080-0000-13 ..... 127
3842-0000-30 ..... 123	4642-0000-22 ..... 120	6010-0000-00..... 105	8080-1000-13 ..... 127
3851-0000-10 .....119	4642-0000-30 ..... 123	6020-0000-00 ..... 106	8080-7900-13 ..... 127
3851-0000-20 .....119	4643-0000-20 ..... 120	6030-0000-00 ..... 105	8080-8900-13 ..... 127
3852-0000-10 .....119	4643-0000-21 ..... 120	6060-0000-00 ..... 104	8081-0000-13 ..... 127
3862-0000-33 .....133	4643-0000-22 ..... 120	6111-0000-00..... 101	8081-1000-13 ..... 127
3871-1000-10 .....113	4651-0000-10..... 120	6131-0000-00 ..... 101	8081-7900-13 ..... 127
3871-2000-10.....119	4651-0000-20 ..... 120	6204-0000-00..... 106	8081-8900-13 ..... 127
3871-6000-21.....119	4652-0000-10 ..... 120	6204-0000-01 ..... 106	8086-6978-68 ..... 127
3871-6000-22.....119	4652-0000-20 ..... 120	6204-0014-00 ..... 106	8101-0100-30 ..... 126
3871-8000-30..... 123	4653-0000-20 ..... 120	6204-0014-01..... 106	8102-0100-30 ..... 126
3872-0100-20.....119	4662-0000-33 .....133	6204-0024-00..... 106	8220-4100-30 .....132
3872-2000-10.....119	4671-2000-10..... 120	6204-0024-01 ..... 106	8240-2100-30 .....132
3872-6000-21.....119	4671-6000-21..... 120	6241-0110-XX ..... 102	8240-2101-30 .....132
3872-6000-22 .....119	4671-6000-22 ..... 120	6241-0111-XX..... 102	8250-4100-30 .....132
3872-8000-30 ..... 123	4671-8000-30 ..... 123	6241-0115-00 ..... 102	8250-4101-30 .....132
3884-0000-18 ..... 121	4672-1000-20 .....113	6241-0130-00..... 102	8250-5101-30 .....132
3884-0000-19 ..... 121	4672-2000-10 ..... 120	6241-1110-XX..... 102	8270-0100-30 ..... 130
3884-0100-01..... 121	4672-6000-21 ..... 120	6241-1111-XX ..... 102	8280-4111-30 .....132
3884-0100-02 ..... 121	4672-6000-22 ..... 120	6300-0400-00..... 103	8401-0000-20 .....114
3884-0100-18..... 121	4672-8000-30 ..... 123	6300-0800-00..... 103	9018-0012-00 ..... 125
3884-0100-19 ..... 121	4673-6000-21..... 120	6310-0000-12 ..... 103	9018-0013-00. ... 116, 120, 123, 131
3884-0100-28 ..... 121	4673-6000-22 ..... 120	6310-0000-24 ..... 103	9018-0019-00 ..... 122, 131
3884-0100-29 ..... 121	4684-0100-18..... 121	6311-0300-00..... 103	9018-0020-00 ..... 116, 120, 124
3884-0200-18 ..... 121	4684-0100-19..... 121	6311-0400-00..... 103	9018-0025-00 ..... 123
3884-0200-19 ..... 121	4684-0200-01 ..... 121	6444-0000-00..... 108	9018-0032-00 ..... 126
4040-0109-10 .....118	4684-0200-02..... 121	7404-0060-00..... 114	9018-0034-00 ..... 128
4040-0109-30 ..... 123	4684-0200-28 ..... 121	7414-0090-00 ..... 114	9018-0035-00 ..... 128, 131
4611-0000-33 .....133	4684-0200-29 ..... 121	7811-0000-33 ..... 133	9018-0051-00 ..... 131
4612-0000-33..... 133	5150-0000-10..... 125	7812-0000-20 ..... 113	9185-40003-3..... 131
4621-0000-10..... 113	5150-0100-10 ..... 125	7812-0000-33..... 133	9185-40034..... 131
4641-0000-10 ..... 120	5150-0100-20..... 125	7822-0000-40..... 113	9186-1500-10 ..... 126
4641-0000-20 ..... 120	5180-0100-10 ..... 125	7841-0000-30 ..... 123	9186-1500-20 ..... 126
4641-0000-21..... 120	5180-0100-20..... 125	7842-0000-30 ..... 123	9186-1501-30 ..... 126
4641-0000-22 ..... 120	5180-0110-10 ..... 125	7862-0000-33 ..... 133	9186-1501-40 ..... 126



9186-1501-50 ..... 126	ECR-MT ..... 149	HC-2 ..... 145	T4 ..... 141
9186-2300-10 ..... 131	ECRP-10-ELBE-500 ..... 146, 149	HC-25C ..... 142, 145	T5 ..... 141
9186-2300-30 ..... 131	ECRP-10-ELSS-XLAC ..... 146, 149	HC-4 ..... 142, 145	TLC ..... 145
9186-2300-XX ..... 131	ECRP-10-GB ..... 149	HC-45C ..... 142, 145	TM ..... 142, 144, 145
9186-2301-XX ..... 131	EJBX-GFI ..... 151	HCGK-25 ..... 96	TM-LC ..... 144, 145
9186-2366-10 ..... 119	EJBX-HMT-TP ..... 151	HHPT ..... 94	TS ..... 81
9186-23882-2540 ..... 131	EJBX-VMT-TP ..... 151	HLGK-15 ..... 96	TSC ..... 81
9186-23882-30 ..... 131	ELBE-500 ..... 139, 145	HLGK-25 ..... 96	UI ..... 142, 145
9186-2610-20 ..... 118	ELBE-500-MMST ..... 143	LC ..... 140, 145	V265 ..... 130, 134
9186-4570-30 ..... 123	ELBE-750 ..... 139, 145	MMST ..... 143, 145	V26W-C00A ..... 111
9186-4571-30 ..... 123	ELRE-SCOUT ..... 136	NB ..... 142, 144, 145	V26W-C00W ..... 111
9186-5300-10 ..... 118	ELRE-SLDC ..... 137, 139, 145	PL ..... 145	V26W-C0VRW ..... 111
9186-5301KC ..... 123	ELRE-SLDC-BL ..... 144	PLMT ..... 140, 145	V345 ..... 130, 134
9186-5515-31 ..... 123	ELRE-XLDC ..... 137, 139, 145	PLO ..... 145	V345-9009 ..... 130
9186-5525-20 ..... 118	ELSS-SLAC-RM ..... 144	PL-POLE-MT ..... 145	V34W-C00W ..... 111
9186-5585-10 ..... 116	ELSS-SLDC ..... 138, 139, 145	POD ..... 145	V34W-C0HRW ..... 111
9186-5585-20 ..... 116	ELSS-SLDC-BL ..... 144	POD-BRACKET ..... 140, 145	V34W-R ..... 111
9186-5586-10 ..... 116	ELSS-SLDC-RM ..... 144	POD-BRACKET-LONG ..... 140, 145	V375 ..... 134
9186-5586-20 ..... 116	ELSS-SLDC-SB ..... 143	POD-PL ..... 140, 145	V37W-C 00R ..... 111
9186-5586-30 ..... 122	ELSS-XLAC ..... 138, 139, 145	PRO ..... 140, 145	V37W-C0HRA ..... 111
9186-8560-29 ..... 124	ELSS-XLAC2 ..... 138, 139, 145	PS ..... 145	V465 ..... 134
9186-8562-30 ..... 131	ELSS-XLAC-HK-LKI ..... 146	PS-PL ..... 145	V46W-C00R ..... 110
9186-8563-30 ..... 131	ELSS-XLAC-PL ..... 138, 140	PU ..... 145	V46W-C00W ..... 111
9186-8563-34 ..... 131	ELSS-XLDC ..... 138, 139, 145	PU-PL ..... 145	V46W-R ..... 110, 111
9186-8564-30 ..... 131	ELSS-XLDC-BL ..... 144	R-1 ..... 81	V795 ..... 134
9186-8565-30 ..... 131	ELSS-XLDC-PU-SM ..... 142	RM-15 ..... 145	V79W-C00W ..... 111
9186-8566-30 ..... 131	ELST-1000 ..... 139, 145	SB ..... 145	WG ..... 145
9186-8580-29 ..... 124	ELST-1500 ..... 139, 145	SC ..... 142, 145	WO ..... 142, 145
9186-8589-24 ..... 124	ELST-1500-AO-SM ..... 144	SC-171 ..... 142, 145	
AFTK-LK ..... 94	ELST-1500-PS-SM ..... 142	SF ..... 145	
AFTK-SK ..... 94	ELST-500 ..... 139, 145	SM2 ..... 142, 144, 145	
AHTK-25 ..... 94	ELST-500-LKI ..... 146	SM2-LC ..... 144, 145	
AHTK-45 ..... 94	E-POLE-W-NB ..... 142	SM4 ..... 142, 144, 145	
AO ..... 145	E-PS-UP-W-SM2 ..... 142	SM4-LC ..... 144	
AO-1 ..... 144	ERWC-10-16 ..... 148	SW ..... 145	
ATGK-3 ..... 95	ERWC-10-28 ..... 148	SZ ..... 81	
BL ..... 145	ERWC-15-10 ..... 148	TI ..... 141	
E-4750-POD ..... 140	ERWC-16-6 ..... 148	T2 ..... 141	



**A**

- Access Kit, Foam ..... 91
- Actuators
  - Air ..... 81
  - Electric ..... 81
  - Handwheel ..... 82
  - Manual ..... 81
  - Rack and Sector ..... 82
- Adapters
  - Double Female ..... 154
  - Double Male ..... 154
  - Female to Male ..... 154
  - Hydrant ..... 154
  - Nozzle ..... 154
  - Pressure-Vacuum, Panel ..... 95
  - Suction ..... 154
- Aerial Valve ..... 83
- Aeromaster 12 ..... 47
- Air Control Box ..... 144
- Air Operated Light ..... 144
- Air Reels, Electric Rewind ..... 148
- AkroFoam Master Stream Nozzle ..... 37
- Akromatic Master Streams ..... 34
- Akromatic Nozzle ..... 47
- Apollo™ Monitors
  - Deck Mount ..... 55
  - Hi-Riser ..... 58
  - Portable ..... 55
  - Portable Electric (PE) ..... 56
  - Single (S.I.) & Dual Inlet (D.I.) ..... 55
  - Single Waterway Monitor ..... 60
- Application Chart
  - Foam System ..... 93
  - Apparatus Valve ..... 78-80
- Applicators
  - Cellar Nozzle ..... 27
  - Coast Guard Approved ..... 28
  - Fog ..... 27
  - Military Approved ..... 29
  - Navy Approved ..... 29
  - Piercing ..... 27
- Aquastream Master Streams ..... 35
- Aries Monitors ..... 64
- Assault™ Nozzles ..... 12-15
- Automatic Nozzles ..... 34-38

**B**

- BackUp Lighting ..... 122-123
- Ball Shutoffs ..... 21
- Ball Valves ..... 79
- Ball Valve Siamese ..... 89
- Ball Valve Wye ..... 88
- Barrel Suction Strainer ..... 155
- Bases, Direct Connection ..... 154
- Basket Suction Strainer ..... 155
- Black Max Piston
  - Intake Valve ..... 85
- Blitz Tips ..... 21
- Brackets
  - Reel ..... 149
- Brass Aries ..... 64
- Brass Fog Nozzles ..... 26
- Breakapart Fog Nozzles ..... 8-15

- Brow Mount Light ..... 144
- Bumper Turret ..... 74-77
- Bush Nozzle ..... 25
- Butterfly Valves ..... 85
- By-Pass Eductor ..... 91

**C**

- Cab Dome Light ..... 127
- Calc, Fire ..... 97
- Calculator, Friction Loss ..... 97
- CAN Monitor Controls ..... 50-51
- Cap Gauge ..... 96
- Cap, Hose ..... 154
- Cap, Pressure ..... 96
- Cellar Nozzle ..... 27
- Cellar Nozzle Applicator ..... 27
- Clamp, Hose ..... 155
- Clapper Valve Siamese ..... 89
- Coast Guard Approved
  - Applicator ..... 28
  - Nozzle ..... 28
- Colored Handles & Pistol Grips ..... 24
- Combination Spanner, Fitzall ..... 152
- Connectors & Plugs Electrical ..... 151
- Conquest™
  - Electric ..... 66
  - Manual ..... 65
- Continuous Swiveling Elbow ..... 154
- Controllers, Electric Valve ..... 83
- Cord Reel ..... 149
- Cord Reel Mounting Bracket ..... 149
- Courtesy Lighting ..... 131
- Crowd Control Monitor ..... 71

**D**

- DeckMaster ..... 43
- DeckMaster, Electric Riser ..... 43
- Deck/Portable Monitor ..... 40-48
- Deluge Tip ..... 22
- Diamondback™
  - Perimeter Warning Lamps ..... 110
  - Scene Lights ..... 133-134
  - Utility Lamp, V-LED ..... 110
  - Warning Lights ..... 110-126
- Direct Connection Bases ..... 154
- Discharge Pipe ..... 23
- Discharge Valves ..... 78-80
- Dome Lamp, 8" Recessed ..... 128
- Dome Lamp, Low Profile ..... 128
- Double Female Adapter ..... 154
- Double Male Adapter ..... 154
- Drain Valve, 3/4" ..... 86
- Drain Valve, Dranit ..... 86
- Dual Shutoff Saberjet ..... 16
- Dual Stacked Tips ..... 23

**E**

- Eductors
  - By-Pass ..... 91
  - By-Pass Truck Kits ..... 91

- In-Line ..... 90
- Portable w/On Board
  - Foam Access ..... 90
- Elbows ..... 154
- Electric Monitor
  - Accessories ..... 51
  - Aeromaster 12 ..... 47
  - Apollo PE ..... 56
  - DeckMaster ..... 43
  - FireFox ..... 41
  - Forestry ..... 40
  - Gemini ..... 42
  - Ladder Pipe ..... 59
  - Renegade ..... 48
  - StreamMaster ..... 44-45, 59
  - StreamMaster II ..... 44, 45, 59
  - Systems ..... 66-71
  - Ultra-High Pressure ..... 77
- Electric Rewind Reels ..... 148
- Electric Riser for DeckMaster
  - and StreamMaster ..... 43
- Electric Valve Actuator ..... 81
- Electric Valve Controls, Navigator ..... 83
- Electrical Cord Reel ..... 148
- Electrical Junction Box ..... 151
- Elevated Monitor, Manual ..... 69
- Extenda-Lite Lights ..... 136-146
- Extrusion Mount Brackets ..... 140-144
- E-Z-Lok ..... 156

**F**

- 4AN Nozzles ..... 29
- Female to Female Adapter ..... 154
- Female to Male Adapter ..... 154
- FireCalc Pocket Calculator ..... 97
- FireFox Monitor ..... 41
- FireFox Nozzles ..... 38
- Fire Stream Calculator ..... 97
- Fitzall Spanner ..... 152
- Flashers, Controllers for Lighting ..... 114
- Flow Meter ..... 95
- Flow Navigator™ Pro ..... 83
- Flow/Pressure Meter ..... 95
- Flow Reach Data ..... 173-177
- Flow Test Kit, Apparatus ..... 94
- Flush Mount Light Head ..... 144
- Foam
  - Akrofoam ..... 37
  - Eductors ..... 90-93
  - Master Stream Foam Tubes ..... 30
  - Nozzles ..... 30-33
  - Tubes ..... 32-33
- Foam System Application Chart ..... 93
- Foam System Layouts ..... 178-179
- Fog Applicator ..... 27
- Fog Nozzles
  - Applicators, Coast Guard ..... 28
  - Assault ..... 12-15
  - Coast Guard Approved ..... 28
  - Military Approved ..... 28
  - Navy Approved ..... 28
  - Saberjet ..... 16-17
  - Turbojet ..... 8



Fog Tips	
Assault	12-15
Coast Guard	28
Military	28
Navy	28
TurboJet	8
Forcible Entry Tools	152
Forestry	
Nozzles	25-27
Forestry Monitor	40
Four-Way Hydrant Valve	87
Friction Loss Calculator	97
Fusion CF Composite Ball	78-80
<b>G</b>	
Gate Valve	87
Gauges	
Cap	96
Line	96
Pitot	94
Pressure	94
Gemini Electric Monitor	42
Gemini Monitor	42, 58, 62, 68
Genesis Monitors	68
GP Manual Monitor	58
Grease	157
<b>H</b>	
Hand Held Pitot	94
Hand Portable Light	140
Handle Cup, Bracket	142
Handle, Remote Control "T"	82
Handles, Colored	26
Heavy Duty Swing-Out Valve	78
Hercules HC	104
HFRT-10, Trident	46
HID Light	133
High Pressure Nozzles	26
Hi-Riser, Apollo	57
Hoist, Hose	157
Holder, E-Z-Lok Nozzle	156
Holder, Spanner Wrench	152
Hose and Ladder Strap	157
Hose Cap	154
Hose Clamps	155
Hose Hoist	157
Hose Jacket	155
Hose Jacket Peg	155
Hose Plug	154
Hose Testing Cap	95
Hydrant Adapters	154-155
Hydrant Flow Test Kit	94
Hydrant Mount	72
Hydrant Valves	87
Hydrant Wrenches	152
Hydrant Wye	88
Hydraulic Monitors	62
Hydraulic Nozzles	34-39
Hydraulic Reels, Electric Rewind	148
HydroMax	78-79

<b>I</b>	
Industrial Eductors	90
Industrial Monitors	60-69
Industrial Turbojet Nozzles	10
In-Line Eductor	90
In-Line Valves	78-80
Intake Pressure Relief Valve	86
Intake Valves	84-85
Interior Lighting	128-132
IR Programmer	110
<b>J</b>	
Jackets, Hose	155
Joystick	51
Junction Box	151
<b>K</b>	
Kits	
Service	168-169
Tool	156
<b>L</b>	
Ladder Pipe, Manual	59
Ladder Strap, Hose	157
Leader Line Wye	88
LED	
Scene Lighting	133-136
Vehical Lighting	110-135
License Illuminators	131
Liftoff, OzzieMaster	54
Light Heads	136-144
Light Weight Apparatus Valve	83
Line Gauges	96
Line Valves	78-80
Live Cord Reel	148-149
Locking Collar Bracket	140
Lubricants	157
Lubriplate	157

<b>J</b>	
Jackets, Hose	155
Joystick	51
Junction Box	151

<b>K</b>	
Kits	
Service	168-169
Tool	156

<b>L</b>	
Ladder Pipe, Manual	59
Ladder Strap, Hose	157
Leader Line Wye	88
LED	
Scene Lighting	133-136
Vehical Lighting	110-135
License Illuminators	131
Liftoff, OzzieMaster	54
Light Heads	136-144
Light Weight Apparatus Valve	83
Line Gauges	96
Line Valves	78-80
Live Cord Reel	148-149
Locking Collar Bracket	140
Lubricants	157
Lubriplate	157

<b>M</b>	
Male to Female Adapter	154
Male to Male Adapter	154
Manual Mast	143
Marker Lighting	124-26
Master Stacked Tips	23
Master Stream Nozzles	34-39
Mercury Monitor	53
Mercury Nozzle	39
MercuryMaster 1000™ Monitor	53
MercuryMaster Oscillating Nozzle	53
Mid-Range Nozzles	
Assault	12
SaberJet	16
TurboJets	8
Mid-X Medium Expansion Foam Tube	31
Military Nozzles	28
Mini Stream Shaper	23
Monitor Extension	43, 57

<b>Monitors</b>	
Aeromaster 12	47
Apollo™	55-57
Apollo Electric	56
Apollo Hi-Riser	57
Apollo PE	56
Aries	64
Conquest	65-66
Crowd Control	71
Deck	41-51
DeckMaster	43
Elevated	69
FireFox	41
Force Protection	71
Forestry	40
Gemini	42, 58, 62, 68
Genesis	68
GP Manual	58
Ladder Pipe	59
Manual Elevated	69
Mercury	53
MercuryMaster 1000	53
Omega	63-65
Omega SD	64
Omega XP, XPV	63
Ozzie	54
Ozzie Master	54
Portable	52-57
Renegade	48
Severe Duty Monitor	61-62
Storm	67
StreamMaster II	44-45
Trident HFRT-10	46
Tuckaway	76
Mounting Fixture, Monitor	57
Mounting Peg	155
Mounting Plate, E-Z-Lok	156
Multiplexing, V-MUX	98-109

## N

Navigator Pro Valve Controllers	83
Navy Fog Nozzle	29
Navy Fog Tip	29
Nodes, V-MUX	104-108
Nozzles	
Adapter	154-155
Adjustable, Manual MercuryMaster	39
AkroFoam	37
Akromatic	37
Applicators, Coast Guard	28
Aquamaster	35
Assault	12-15
Attic	27
Ball Shutoff	21
Brass Fog	26
Breakapart, Assault	10-13
Breakapart, TurboJet	7-10
Bush	25
Coast Guard Approved	28
Deck Pipe	41-51
Foam	30-33
Forestry	25
Holder, E-Z-Lok	156
Mid-Range	5, 9, 14, 16
Military Approved	28-29
Navy Approved	29
Oscillating MercuryMaster	53
Playpipe, Shutoff	20
Provenger	19
Revolving Cellar	27
SaberJet	16-17
SaberMaster	34
Turbojet	6-11

## O

Occupant Restraint Indicator	106
Off Truck Foam Kit	91
Omega	63-65
Omega, Severe-Duty	64
Oscillating Flange	72
Oscillating MercuryMaster Nozzle	53
Oscillating Monitor	54
Outrigger Lamp	119
Ozzie	54
Ozzie Master	54

## P

Panel Adapter, Pressure-Vacuum	95
Parker O-Lube	157
Peg, Hose Jacket	156
Piercing Applicator & Extension	27
Pipes	
Discharge	23
Ladder	59
Pistol Grip, Colored	24
Piston Intake Valve	85
Pitot Gauge	94
Plain Tip	22
Plain Wye	88
Platform Monitor	42-48

## Playpipes

Axial	20
Playpipe Nozzles	20
PL Series Light	140
Plug, Hose	154
Plugs & Connectors Electrical	151
Pneumatically Operated Light	144
Point and Aim Joystick	51
Portable Deck Monitor	54-57
Portable Flow Meter	95
Portable Light	140
Portable Mount	140
Position Indicators	
Monitor	51
Valve	82
Pressure, Flow Meter	95
Pressure, Gauge	96
Pressure Relief Valve	96
Pressure-Vacuum Panel Adapter	95
Proportioners	
By-Pass Eductor	91
In-Line Eductor	90
Truck Installations	91
Provenger Nozzles	19
Pull-up Flood Light	142
Pull-up Poles	142
Pump Panel Lamp	130
Push-up Poles	142
Pyrolite Fittings	
Double Females	154
Double Males	154
Hydrant Wye	88
Hydrant Valve, 4-Way	87
Leader Line Wye	88
Suction Siamese	89
Water Thief	88

## Q

Quarter Turn Drain Valve	86
Quick-Attack Foam Tubes	32
Quickfit Sprinkler Shutoff	156

## R

Rack and Sector Actuators	82
Rampage	35
Reach Data, Flow	173-177
Receptacles	151
Recess Mount Light	144
Recessed Interior Dome Lamp	128
Recessed T-Handle	82
Reels	
Brackets	149
Cord	148-149
Electric Rewind	148
Remote Control	82
Remote Control T-Handle	82
Remote Control Monitor	40-43
Remote Control Systems	66-71
Renegade Monitor	48
Repair Kits	168-169

Revel™ Scene Light	137
Revel Scout™	136
Revolving Cellar Nozzle	27
Revolution Intake Valve	84
Riser, DeckMaster	43
Roof Turret	75
Running Board Mounting Peg	155

## S

Saber Shutoff	16
SaberJet™ Nozzles	16-17
SaberMaster 1250	34
Scene Lighting	136-147
SceneStar LED Scene Light	138
Scout, Revel	136
Sealed Vista IV	102
Seatbelt Indicator, System	106
Sensor, Heat	108
Service Kits	168-169
Severe-Duty Monitor	61-62
Shutoffs	
Nozzles, Ball	21
Playpipe, Nozzles	20
Quickfit Sprinkler	156
Saber	16
Trigger	26
Siamese	
Clapper	89
Plain	89
Pyrolite	89
Suction	89
Side Mount Brackets	142
Single Gallonage Master Stream	38
Single Inlet Apollo	55
Slo-Cloz	82
Spanner Wrench Holder	152
Spanner Wrenches	152
Specialty Nozzles	25-27
Sprinkler Shutoff, Quickfit	156
Stacked Tips	23
Stepwell Lighting	131
Stop, Turn & Tail Lighting	118-121
Storm	67
Strainers, Suction	155
Strap, Hose & Ladder	156
StreamMaster II	44-45
Stream Shaper, Mini	23
Strobe Light	110, 114
Suction Adapters	154
Suction Elbow	154
Suction Siamese	
Clapper	89
Plain	89
Pyrolite	89
Suction Strainers	155
Suction Valves	89
Super Light, Light Head	138
Swing-Out Valve Guide	158-159
Swing-Out Valves	81-82
Swing-Out Valves, Heavy Duty	81-82
Swivel Base Light	143
Swivel Joint	154





Swiveling Elbow ..... 154  
 SystemDesigner Software.....100

### T

Tail Lamp Assemblies ..... 118-121  
 Tank Washdown System .....70  
 Test Gauge Kit .....95  
 Thief, Water .....88  
 Three-Way Hydrant Wye.....88  
 Three-Way Suction Siamese.....89  
 Three Wrench Holder ..... 152  
 Through the Roof Mount ..... 142  
 Tips  
     Assault .....12-15  
     Blitz ..... 21  
     Coast Guard, Fog .....28  
     Deluge.....22  
     Military Fog.....28  
     Monitor .....23  
     Navy Fog.....28  
     Plain.....22  
     Stacked.....2  
     Turbojet .....6-11  
 Tool Kit..... 156  
 Top Mount Brackets ..... 142  
 Top Mounting Fixture, Monitor..... 57  
 Trident HFRT-10 .....46  
 Trigger Shutoff.....26  
 Tripod.....140  
 Tripod Mounting Bracket ..... 14  
 Tri Tail Lamps ..... 121  
 Turbojet™ Nozzles .....6-11  
 Turbomaster .....35  
 Turrets .....74-77  
 Twist Lock Bracket ..... 142

### U

Ultra High Pressure Bumper Monitor ..... 77  
 Ultra High Pressure Bumper Turret..... 77  
 Ultra High Pressure Handline Nozzle..... 26  
 Universal II Monitor  
     Control System..... 50  
 Upper Deck .....57  
 Utility Lighting  
     Courtesy Lamps..... 131  
     Diamondback V-LED Utility Lamp.....130  
     Dome/Pump Panel Lamp.....128  
     License Illuminator / Stepwell..... 131  
     Stepwell Lamp..... 131  
     Utility Lamps .....131  
     Work Lamp, LED .....130

### V

Valve Controllers..... 83  
 Valve Guide..... 158-167  
 Valves  
     Apparatus.....78-80  
     Butterfly.....85  
     Controllers .....83  
     Discharge .....78-80  
     Drain, Valve, 3/4" .....86  
     Dranit, Drain Valve.....86  
     Gate.....87  
     Hydrant Valve, 4-Way.....76  
     In-Line.....78-80  
     Line .....78-80  
     Meter, Flow/Pressure.....95  
     Piston Intake.....85  
     Pressure Relief .....96  
     Suction.....89  
     Swing-Out.....78-83  
     Vari Nozzle .....28-29  
 Vehicle Data Recorder (VDR).....108  
 Vehicle Scene Lighting.....133-134  
 Vehicle Washdown System.....70  
 Vista IV Display .....102  
 V-MUX Multiplexing System .....98-108  
     Diagnostic Software .....101  
     Downloader Software .....100  
     Field Service Kit, Diagnostics.....101  
     Input/Output Nodes .....105-108  
     Pods / Switches.....103  
     SystemDesigner Software.....100  
     VFD Display .....108  
     Vista IV Display.....102  
     Vista IV, Sealed .....102

### W

Warning Lighting .....110-115  
 Washdown Systems  
     Tank.....70  
     Vehicle .....70  
 Water Flow Test Kits.....94  
 Water Thief.....88  
 Wide Range Turbojet .....9  
 Wildland Nozzles .....25  
 Work Lamp, LED .....130  
 Working Light, Revel Scout .....137  
 Wrench Holders.....152  
 Wrenches, Hydrant.....152  
 Wrenches, Spanner.....152  
 Wye.....  
     Gated .....88  
     Hydrant.....88  
     Leader Line .....88  
     Plain.....88  
     Pyrolite .....88

### Z

ZT Nozzle Grip .....25

From our global sales team to our customer care service and engineering staff, we endeavor to provide peace of mind for you, no matter what the location in the world.

**Ohio, USA Headquarters:**

Customer Care and Technical Assistance representatives are available Monday through Friday 8:00 A.M. – 5:00 P.M. EST.

**Akron Brass Company:** 800.228.1161 | 330.264.5678

**Weldon, a division of Akron Brass:** 800.989.2718 | 614.529.7230

**Contact Customer Care for:**

- Product orders and special requests
- Access to detailed product information
- Shipment details

**Contact Technical Support for:**

- Product troubleshooting
- Technical data such as parts lists, instructions, drawings
- Product repair seminars

**How to Order:**

Customers: Contact your local authorized Akron Distributor. Visit [akronbrass.com](http://akronbrass.com) to locate a distributor near you.

Distributors / OEMs: Send your orders to [akroncare@idexcorp.com](mailto:akroncare@idexcorp.com)

**How to return your product for Service & Warranty Evaluation:**

Submit your request online at [onlinerepair.akronbrass.com](http://onlinerepair.akronbrass.com) or call Customer Care for estimates and shipping instructions.

**How to return your product for Credit:**

Submit your request online at [akronbrass.com/customer-support-returns](http://akronbrass.com/customer-support-returns) or call Customer Care for a Return Materials Authorization (RMA) number.

**Follow us on:**



# Tested... Proven... Trusted.





For more information on Akron and Weldon warranties, visit our website at:  
[akronbrass.com/customer-support-warranty](http://akronbrass.com/customer-support-warranty)

© 2018 Akron Brass Company. All rights reserved. Akron, Akron Brass, AeroMaster12, Akrofoam, Akrolite, Akromatic, Akroview, Apollo, Aquaream, Aries, Assault, Black Max, Bronco, Challenger, Conquest, Deckmaster, Defender, Diamondback, Excel 1000, Extenda-Lite, FireCalc, FireFox, FoamFill, Force, Gemini, Genesis, Hi-Riser, Link2, Matrix, Mercury, MercuryMaster 1000, Mid-X, Navigator, Nightbreaker, Omega, Ozzie, OzzieMaster, ProVenger, Pyrolite, Quick-Attack, Rampage, Renegade, Revel, Revel Scout, Revolution, Rover, Saber, SaberJet, SaberMaster, SceneStar, Slo-Cloz, Storm, Streammaster, Swing-Out, SystemDesigner, Tested, Proven, Trusted, Tork-Lok, Trident, Tuckaway, Turbojet, Turbomaster, UltraJet, V-LED, V-MUX, Zero Torque and the Akron Logo are registered and unregistered trademarks of the Akron Brass Company. All other trademarks are the properties of their respective owners.



Akron Brass is OHSAS 18001: 2007 registered from Eagle Registrations Inc. Certificate number 4374. This achievement attests to our commitment to provide a safe work environment.



Akron Brass is ISO 9001: 2008 registered from Eagle Registrations Inc. Certificate number 3875. This achievement attests to our commitment to provide high quality products and services.



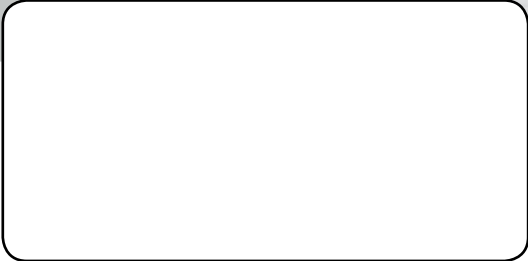

Contact Your Authorized Distributor:



A Unit of IDEX Corporation